

ENGLISH WITH CROSSWORDS

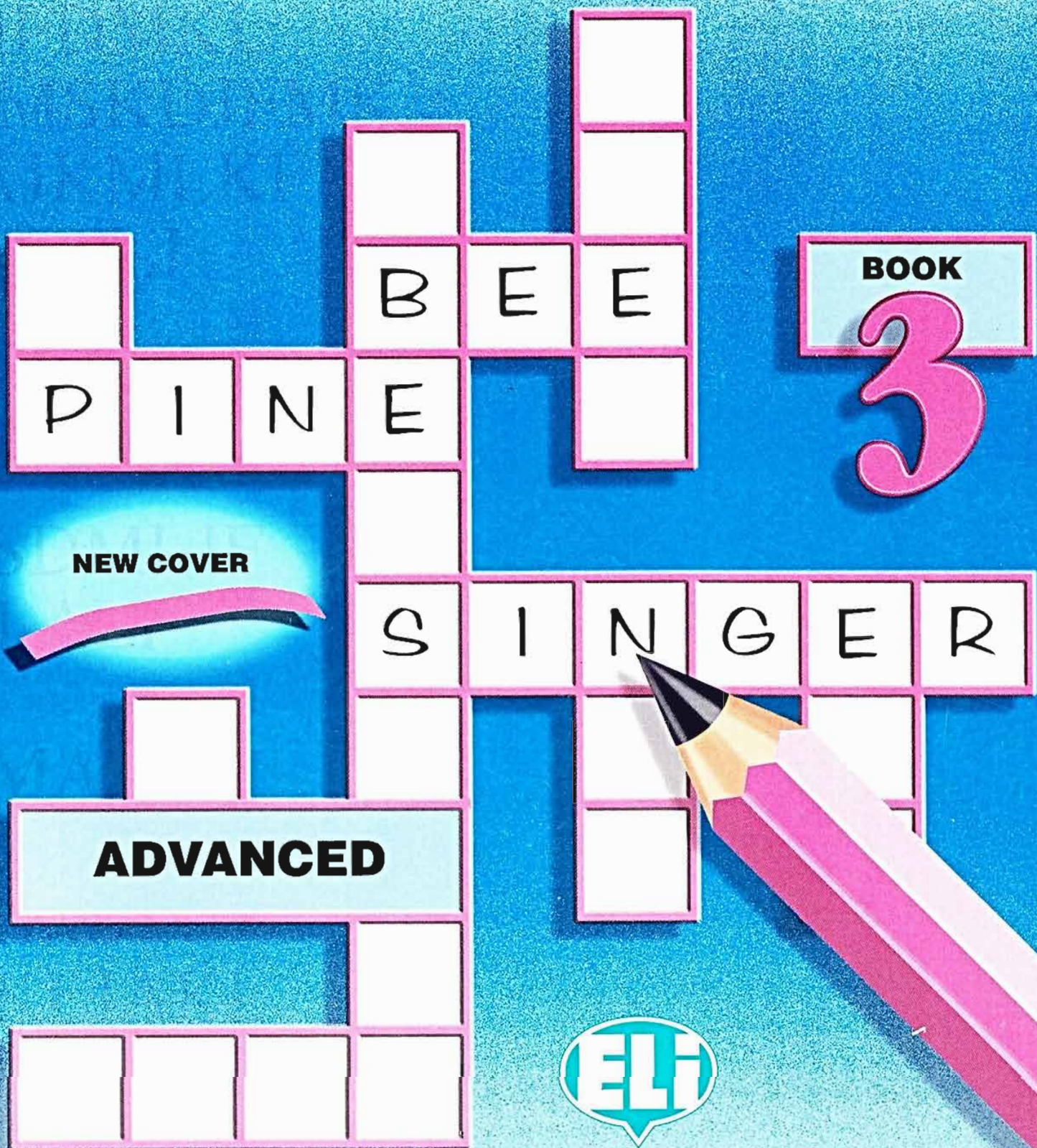

ENGLISH WITH CROSSWORDS

3 **Advanced**



EUROPEAN LANGUAGE INSTITUTE

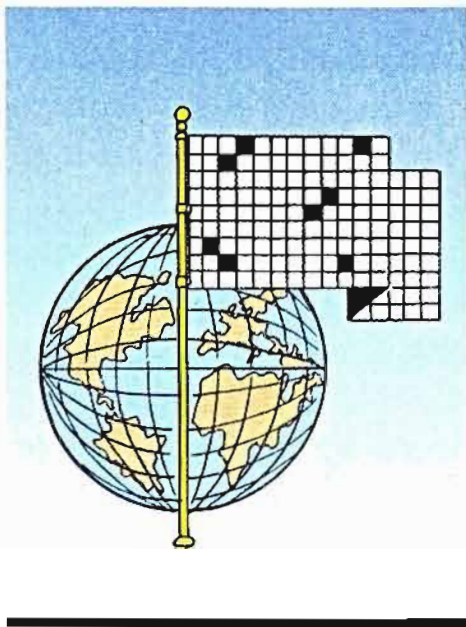

The first two volumes of **ENGLISH with CROSSWORDS** created a lot of interest in schools throughout the world. Following this enthusiastic reception, we are pleased to announce this third volume in the series.

As in the other two volumes, the main aim of the book is to provide a way of learning vocabulary which, apart from

being informative, is also enjoyable and entertaining. Students of all ages can now learn new words through games and images.

The team of mother tongue teachers responsible for the other two books in the series has chosen **14 new subjects** which contain **20 words each**. All the words are illustrated on the page preceding the crosswords.

The first page of crosswords in each unit concentrates on 10 words drawn from the main subject. With the help of the illustrations, the student can insert the words in the right spaces.

The second page relates to the other ten words included in the unit.

The third page takes five words from the first page and five from the second.

The fourth page features the remaining five words from pages 1 and 2.

In the fifth and final crossword of each unit, all the words are included and the student will find that in completing the first four pages, he or she will have memorised the 20 words and will be able to fill in the final crosswords without too much difficulty.

Teachers will find that **ENGLISH with CROSSWORDS 3 Advanced** can be used to check or increase the students' level of vocabulary. The crosswords can also be used as an enjoyable homework exercise. Lastly, during summer holidays they provide an entertaining way of revising and maintaining contact with English.

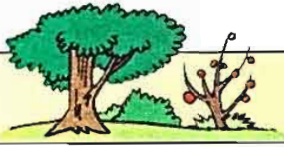

TREES AND PLANTS

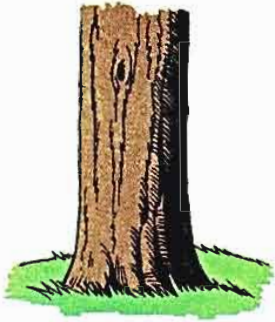

trunk



branch



leaves



flower



roots



chestnut



pine

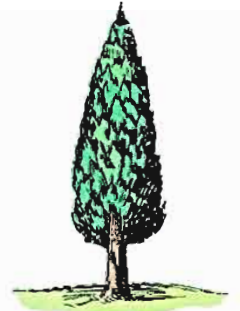

cypress



fir



apple tree

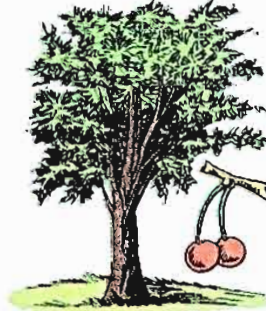

cherry tree

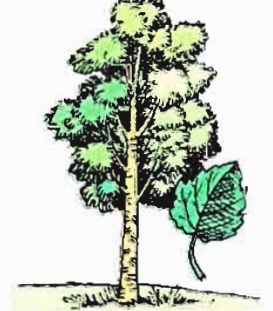

poplar



weeping willow



palm



oak

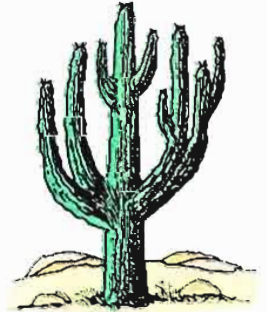

cactus



mimosa



ivy



holly



grass

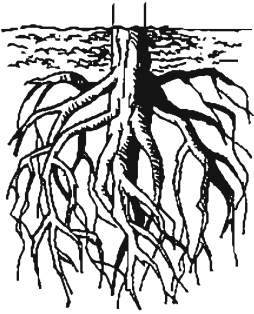

1

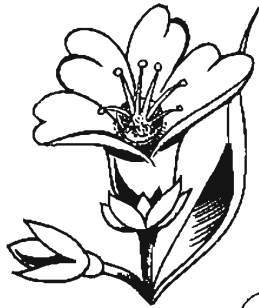

2



3



4



5

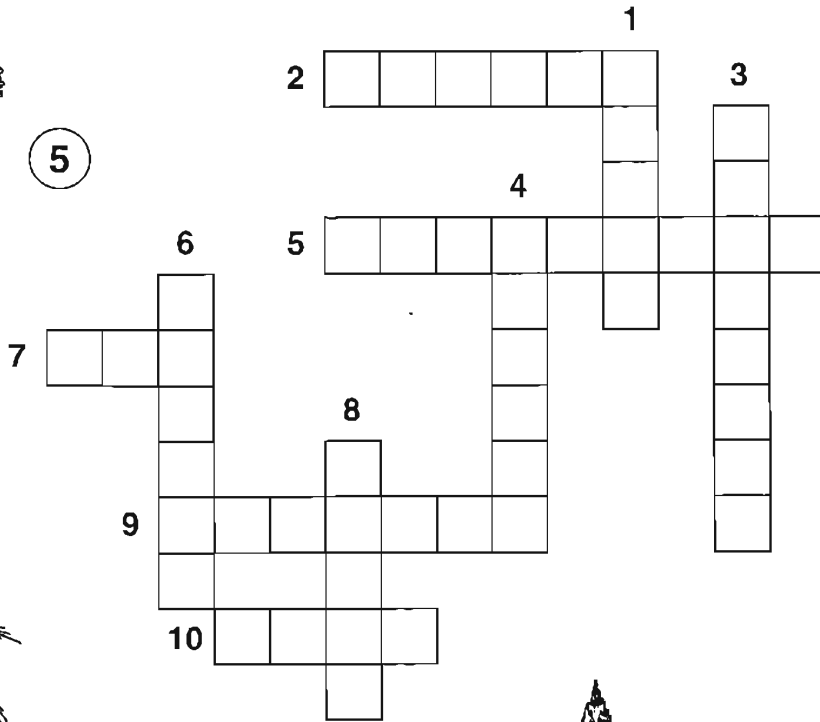

7



6

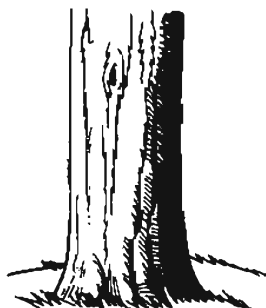

8

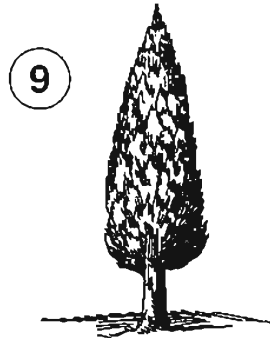

9

10



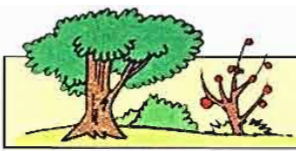

1



2



3



4



5



6

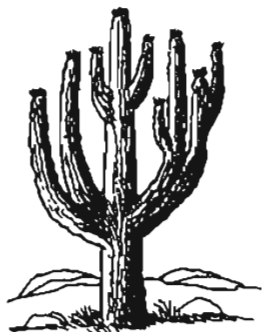
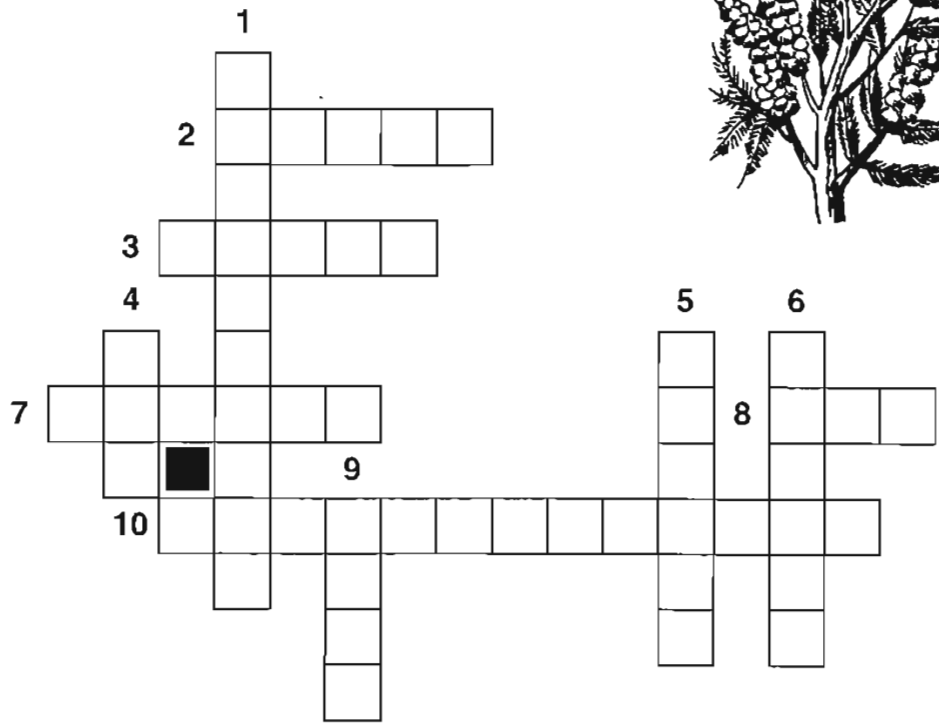

7



8



9



10

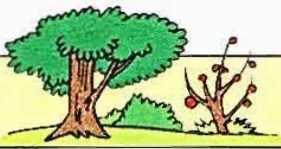

1



2



3



4



5

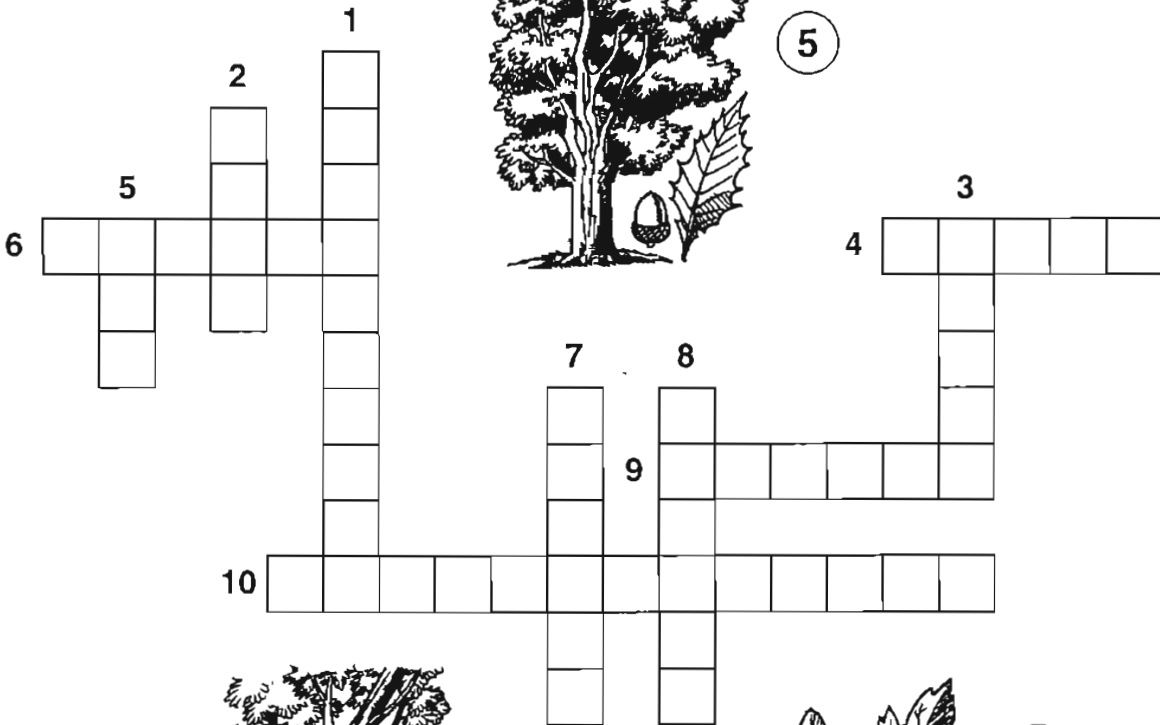

7



9



6



8



10

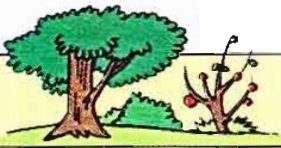

1



2



3



4

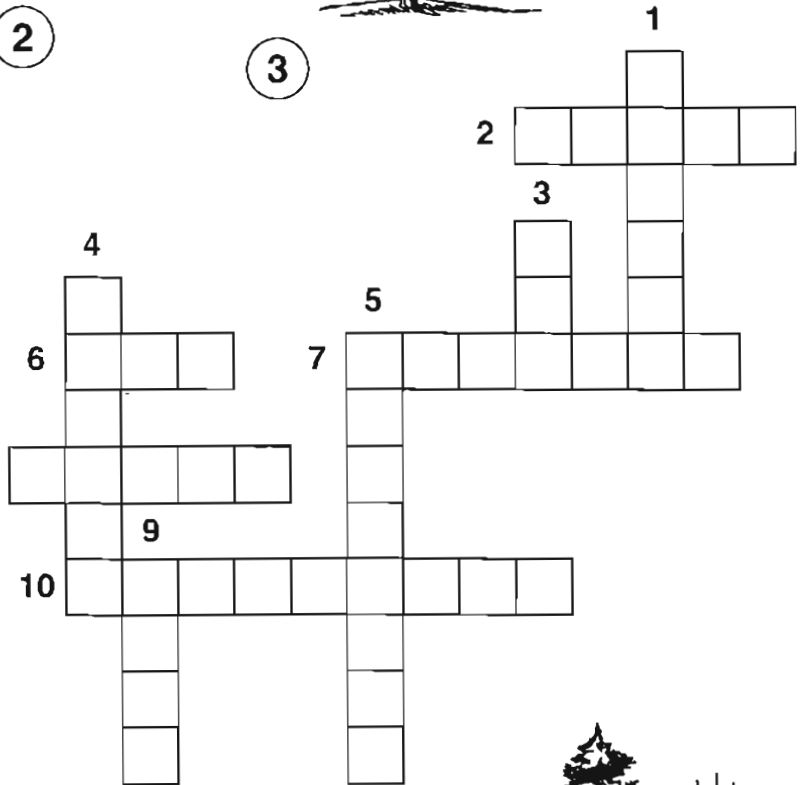

5



6



9



7



8

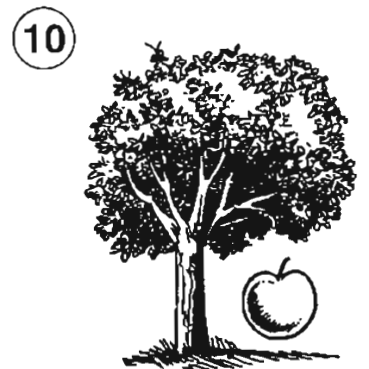

10

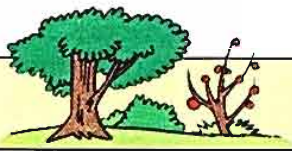

1



2



3



4



5

6



7



8

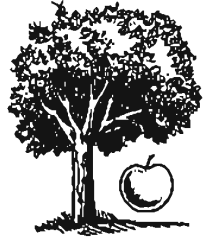

9

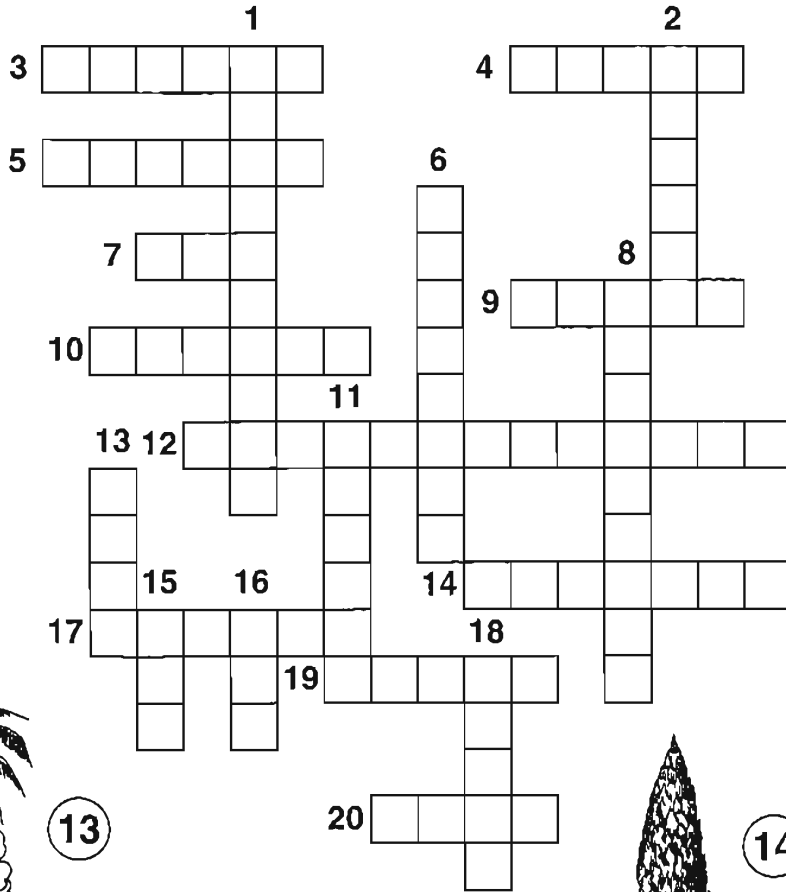

10



11

12



13

15



16

17



18

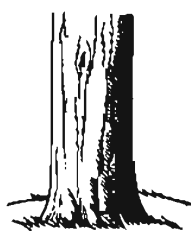

19



14

20





SMALL ANIMALS

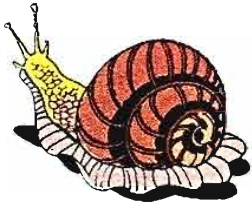

snail

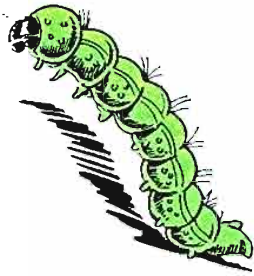

caterpillar



butterfly

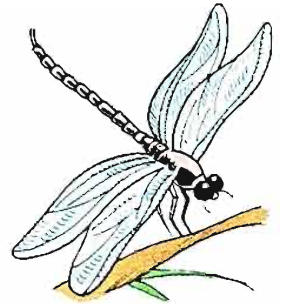

dragonfly

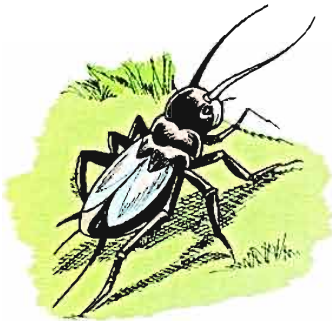

cricket

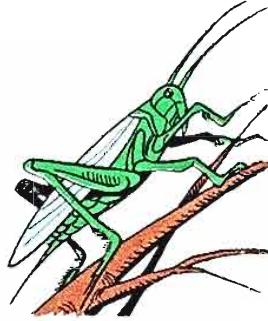

grasshopper

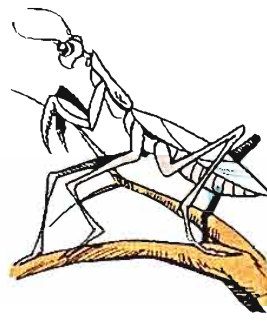

praying mantis



scorpion

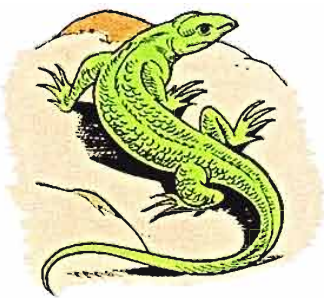

lizard

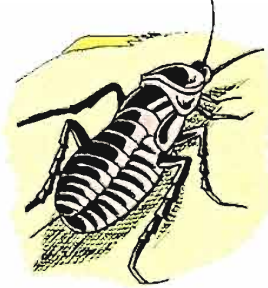

beetle

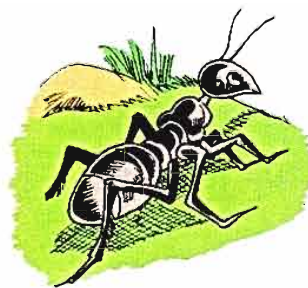

ant

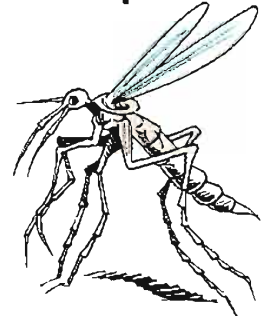

mosquito

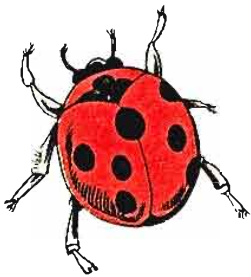

ladybird



spider

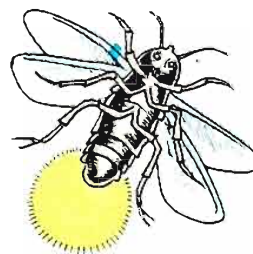

firefly



fly



bee



wasp



clothes moth

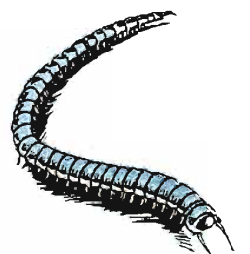

millipede

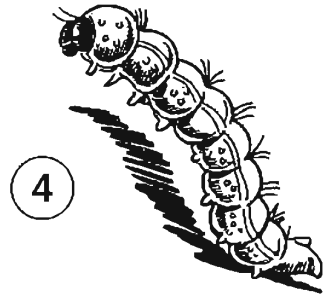
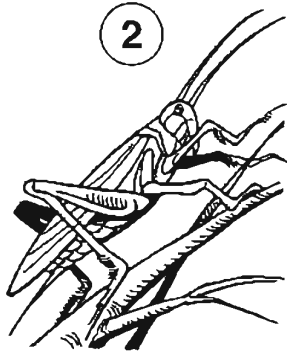
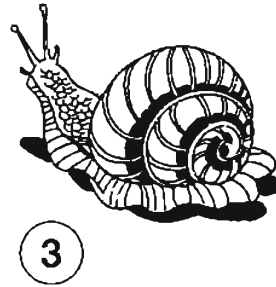
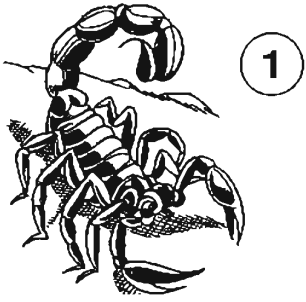

1

3

6

7

8

9

10

2

4

5

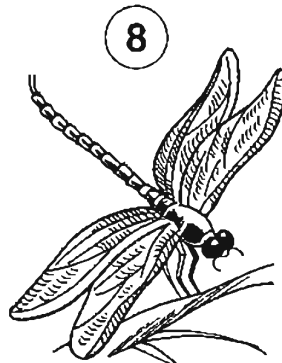
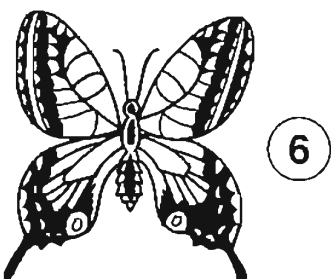
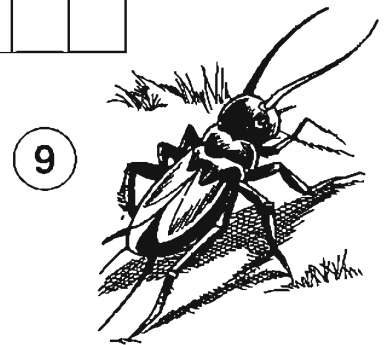
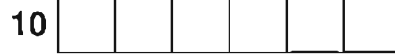
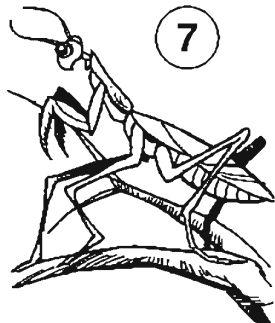
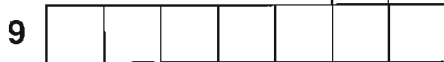
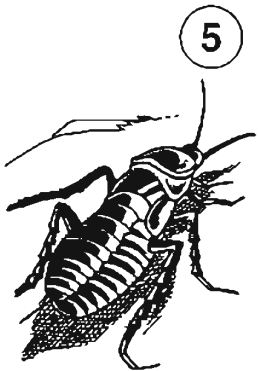

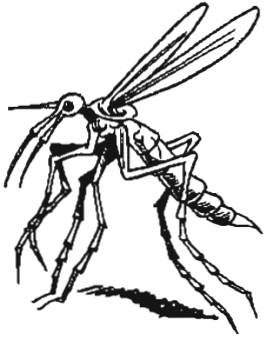

1



2



3



4



5

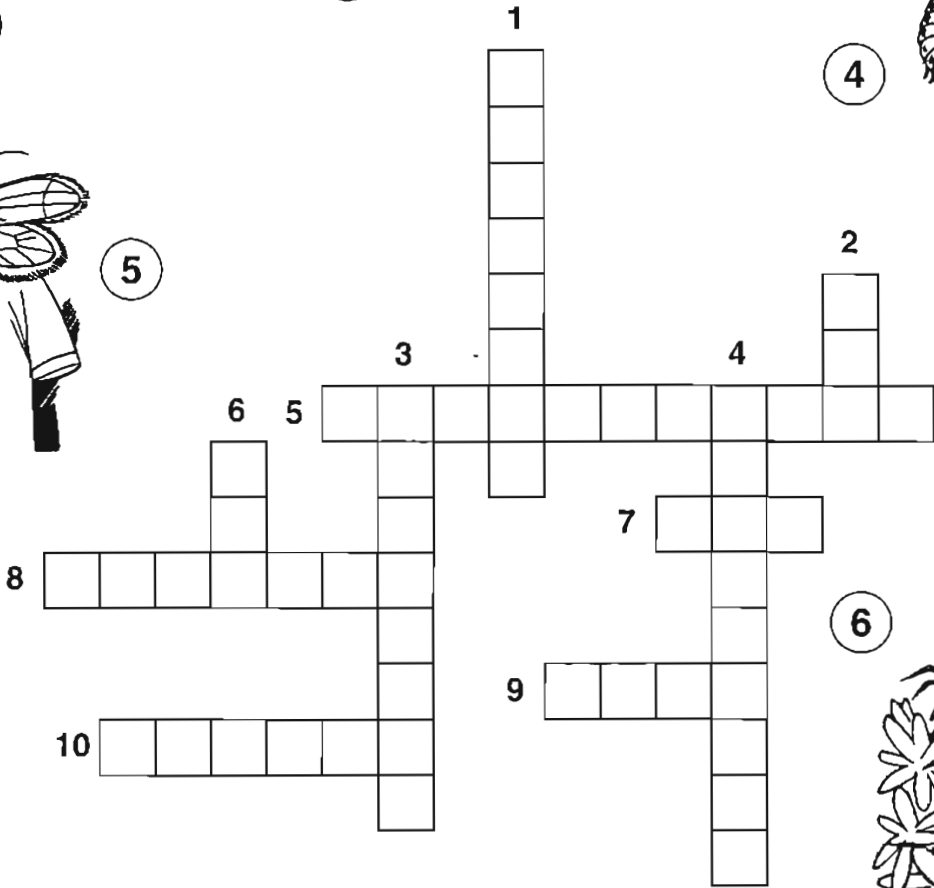

2



7

6



9



8



10





1



2

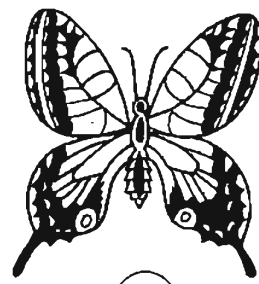

3

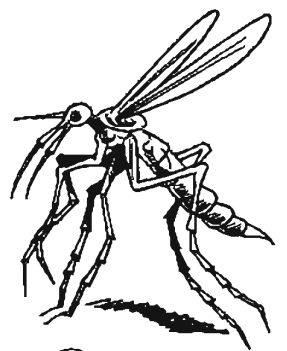

4

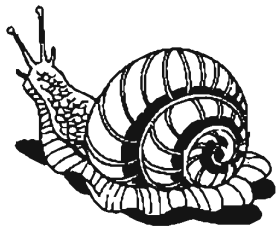

5

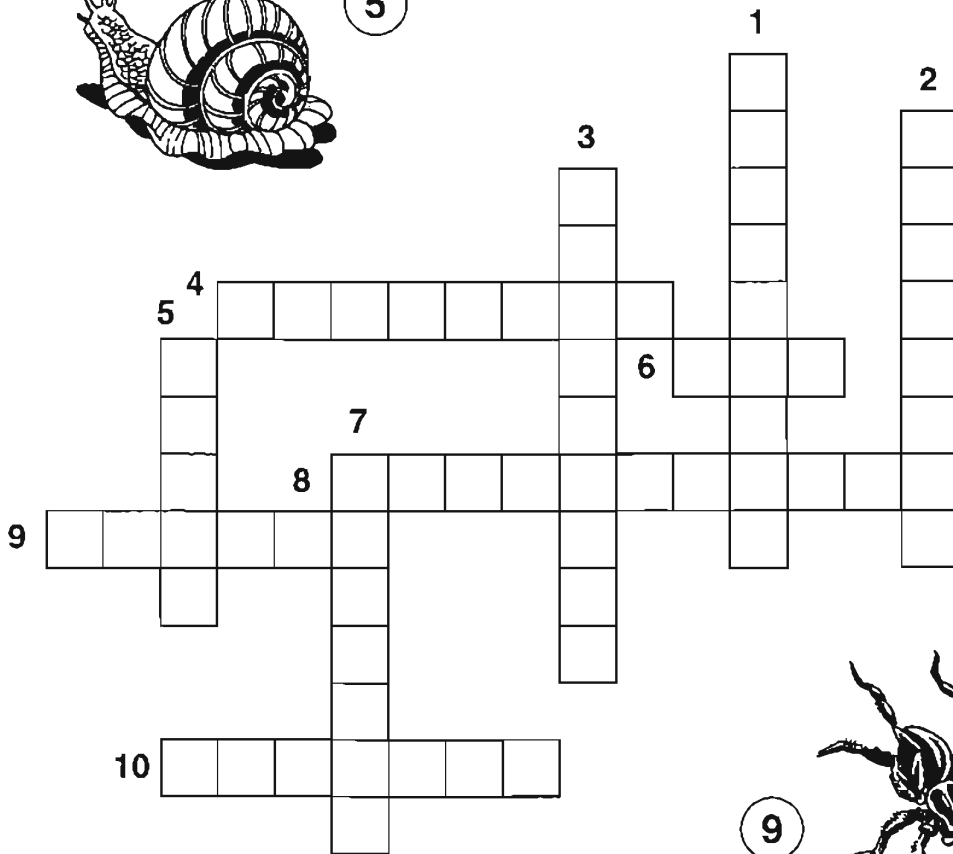

6

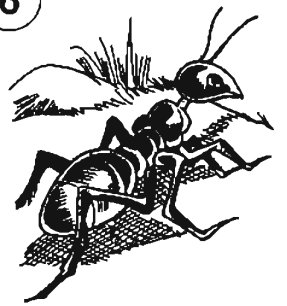

9



10

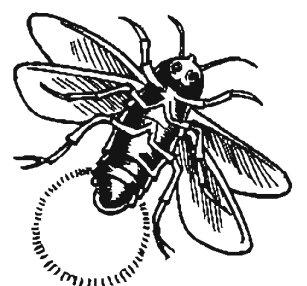

7

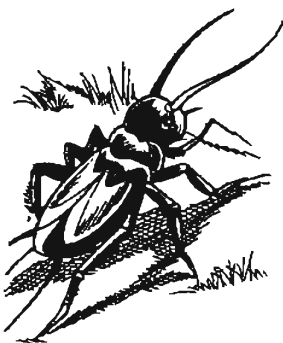

8

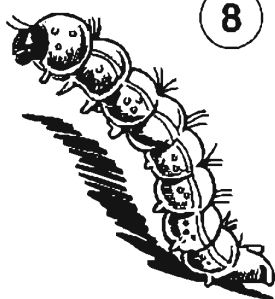



1



2

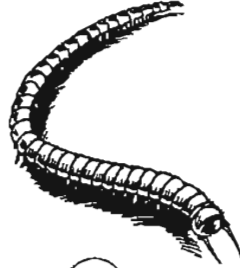

3



4



5

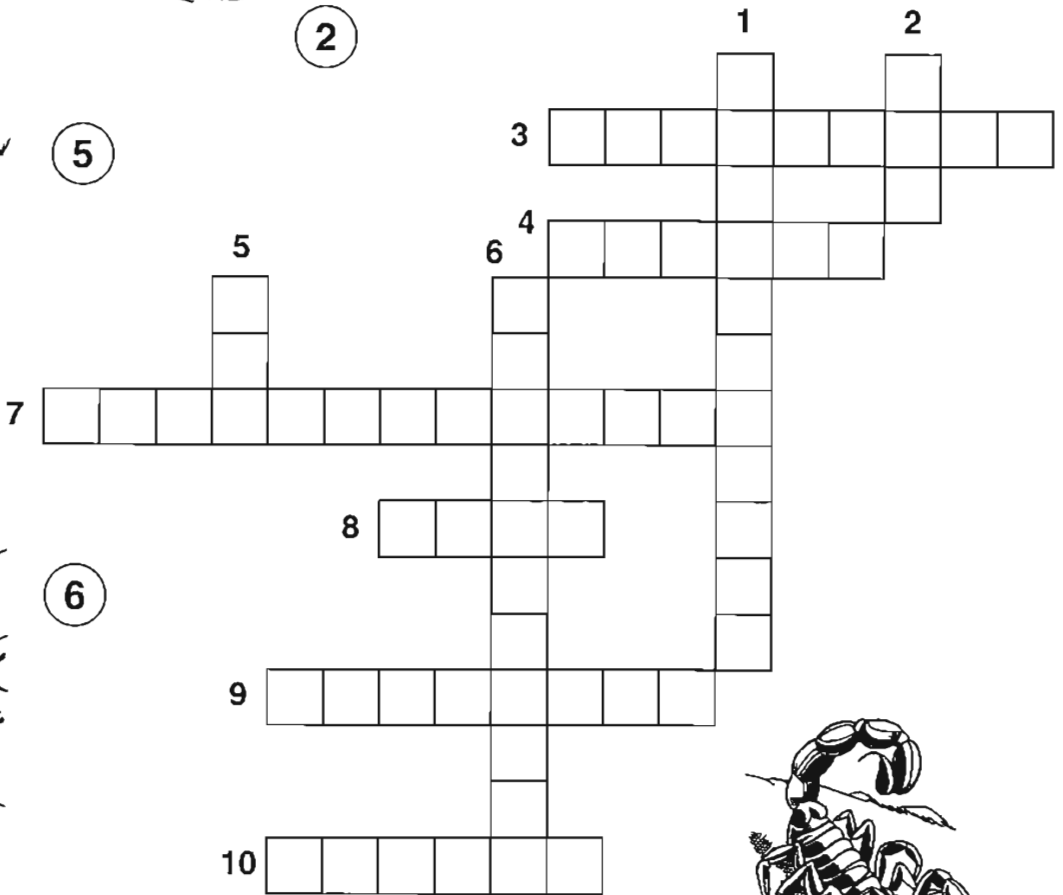

6



9



7



8



10



1



2



3



4



5



6

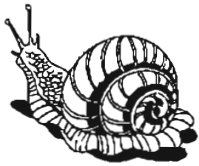

7



8

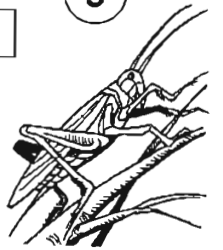
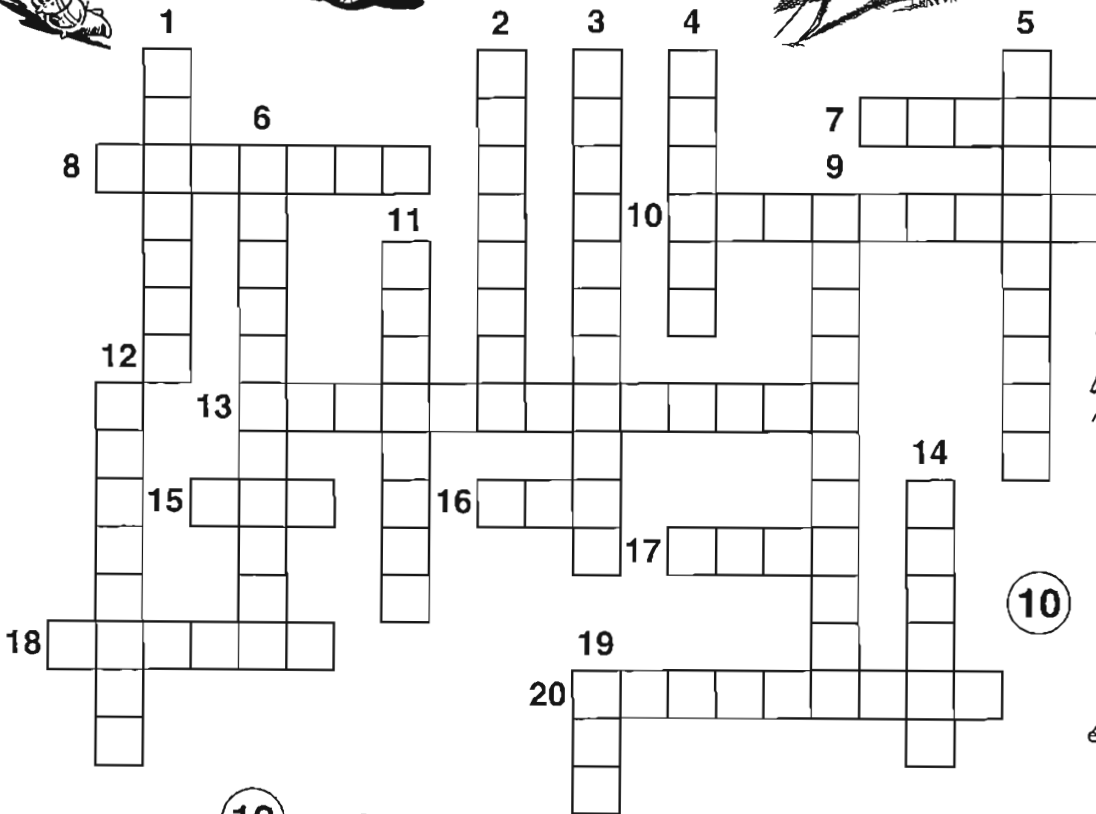

9



10



11



12



13



14



15



16



17



18



19



20



ANIMAL FEATURES



wings



beak



talons

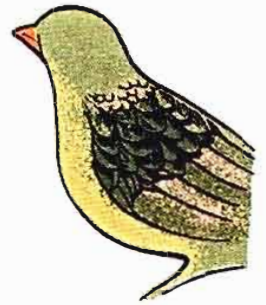

feathers

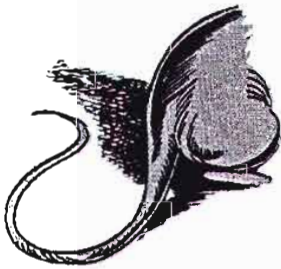

tail



antlers



ears



muzzle



mane



hooves

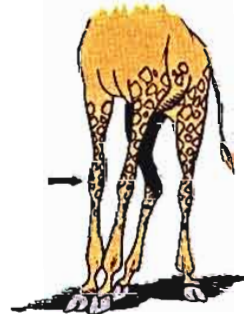

legs

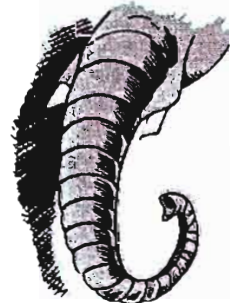

trunk

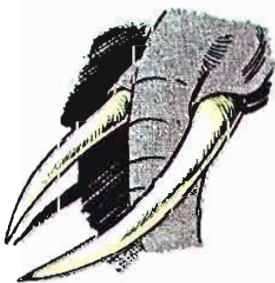

tusks

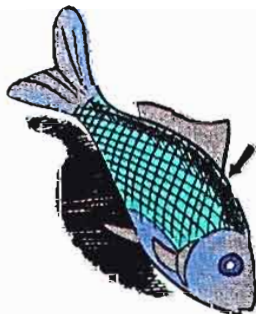

scales

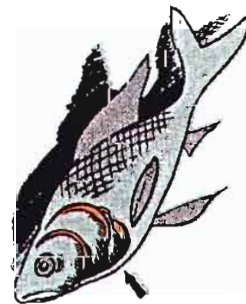

gills

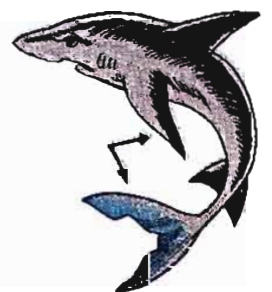

fins



coat



claws

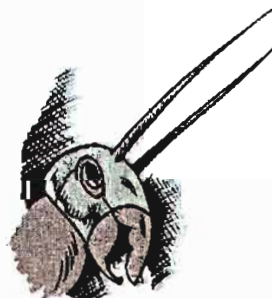

feelers



sting



1



2



3



4



5

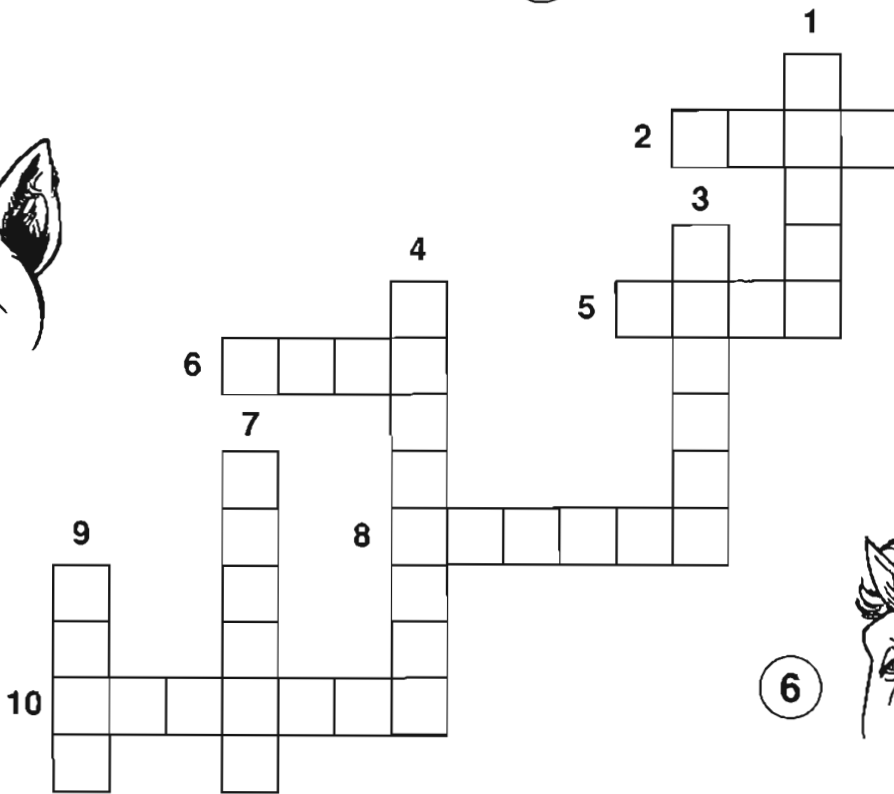

6



7



9



8



10

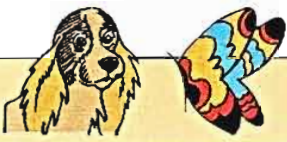

1

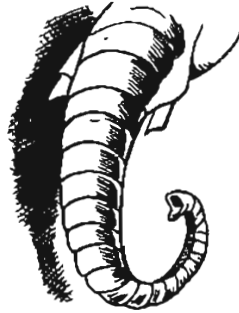

2



3

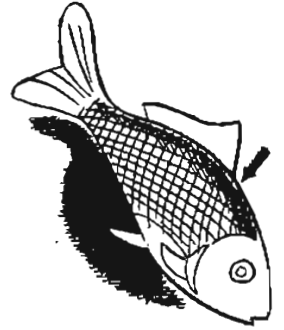

4

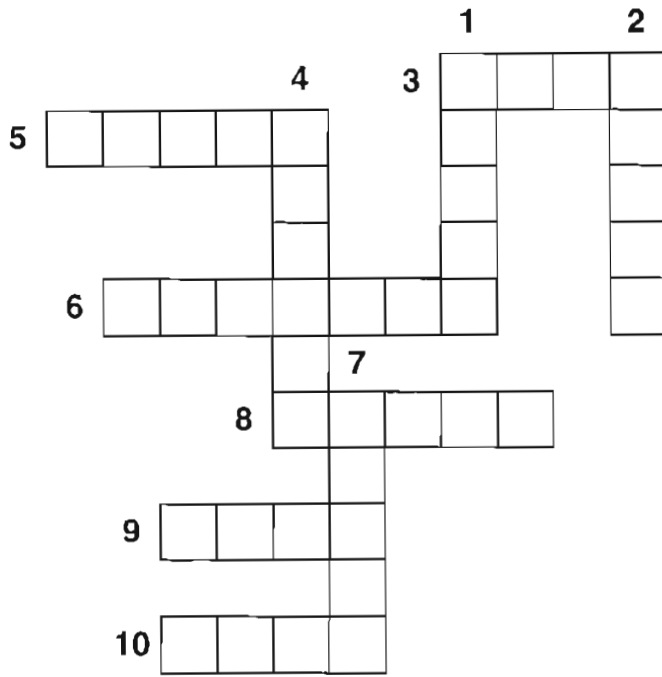

5

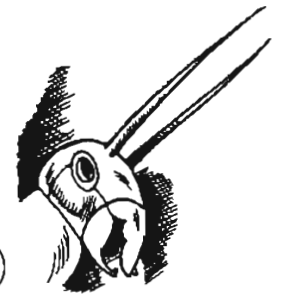

6



7

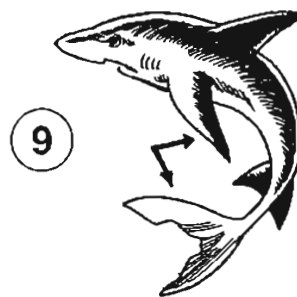

9



8

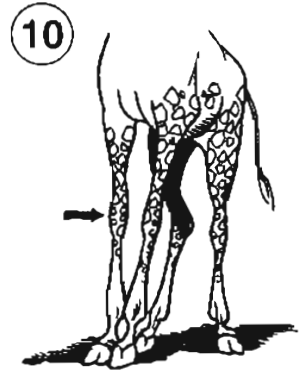

10

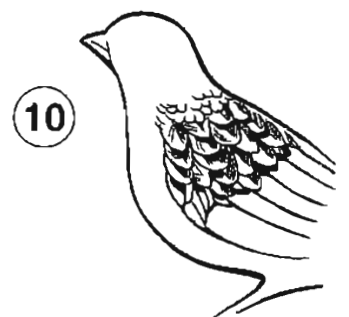
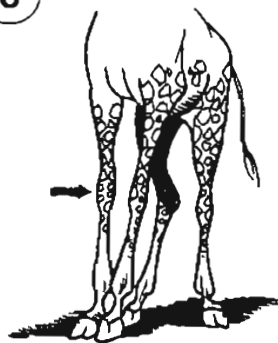
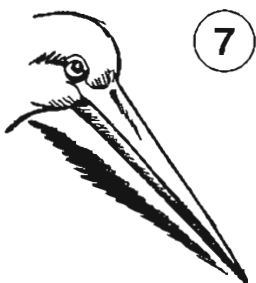
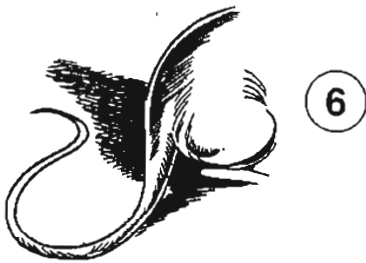
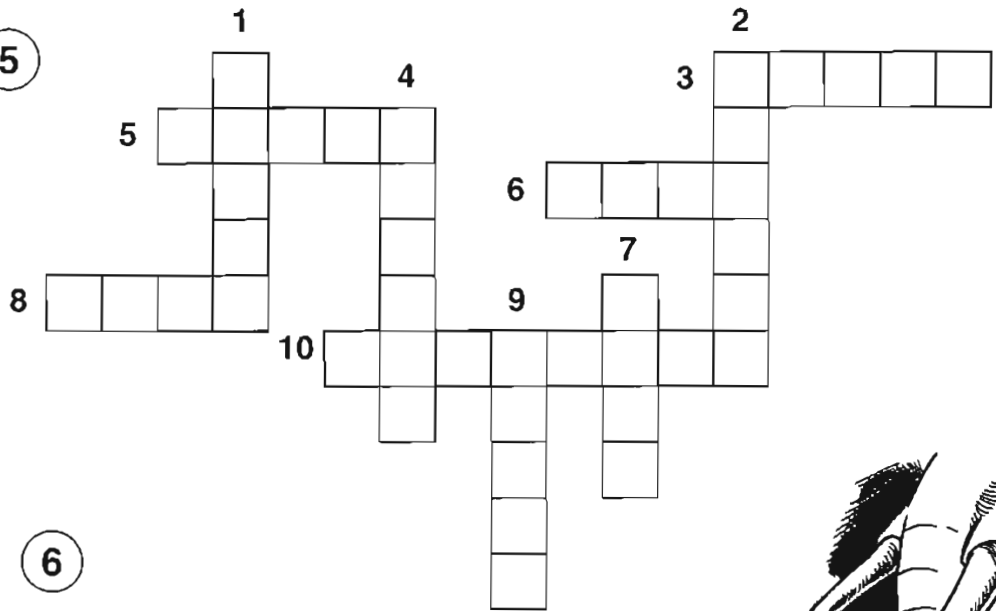
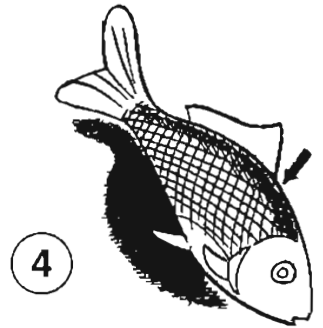
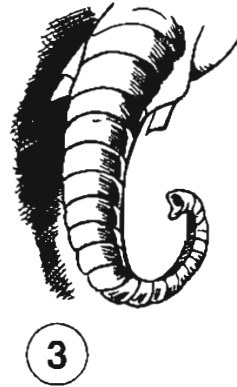
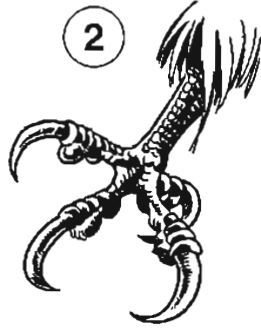



1



2



3



4



5

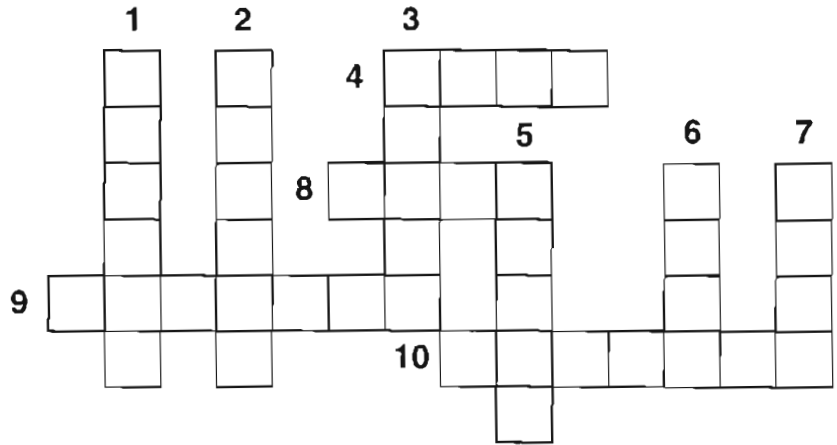

6



9

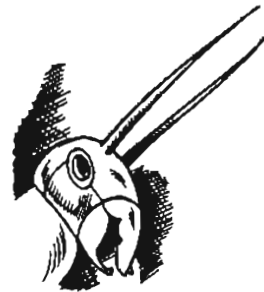

8



10



7



1



2



3



4



5



6



7



8



9



10

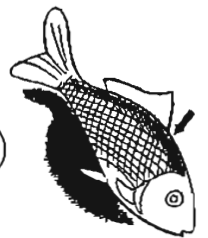
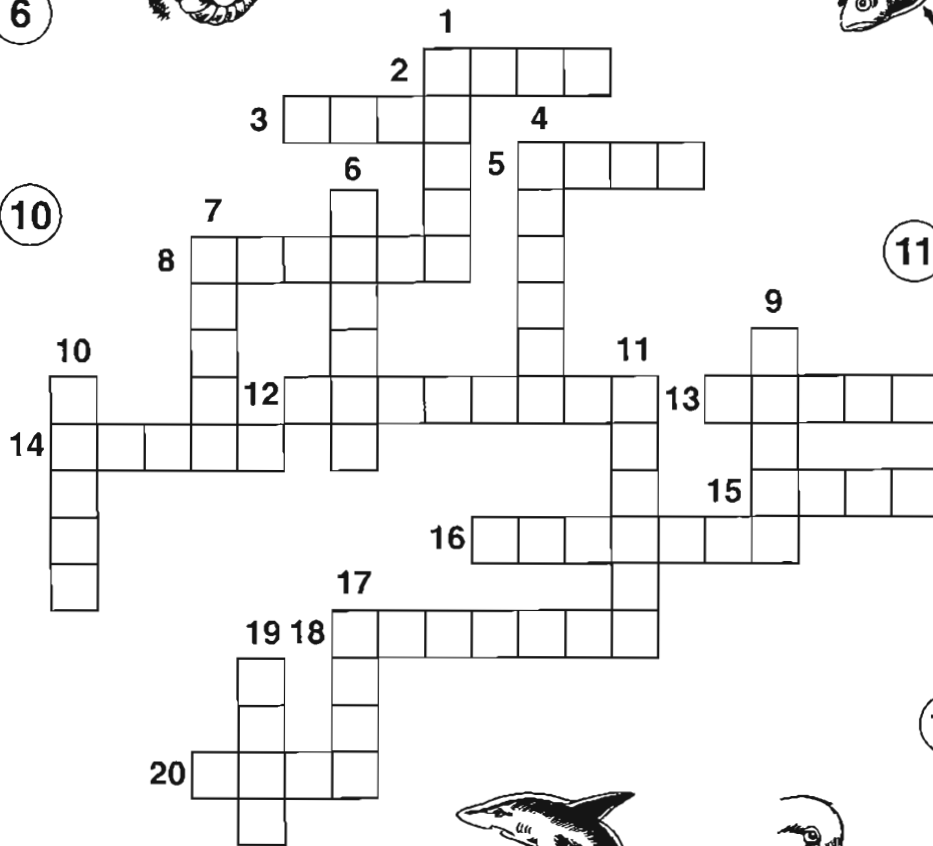

11



12



13



17



19



15



16

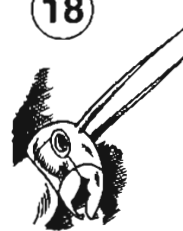

18



20



14



SHOPS



stationer's



florist's



jeweller's

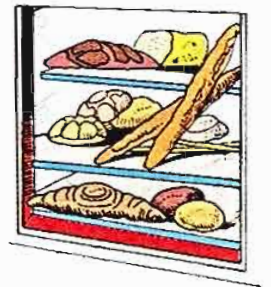

baker's

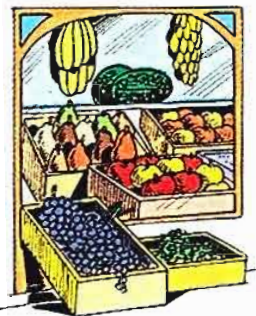

greengrocer's

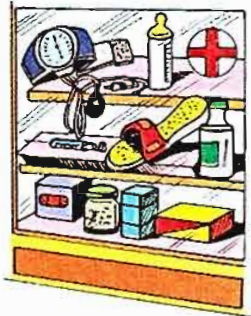

chemist's



fishmonger's



supermarket



shoe shop



bookshop



optician's

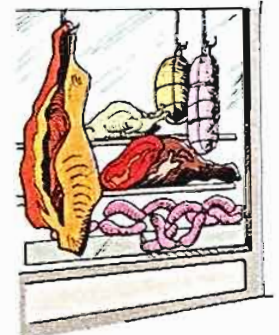

butcher's



boutique



toy shop



newsagent's



travel agency



cafeteria



hairdresser's



barber's



tailor's

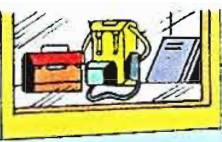

1

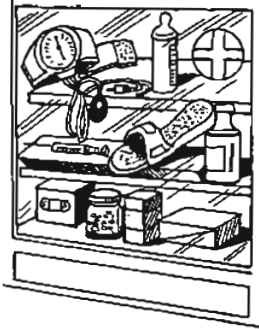

2



3



4



5

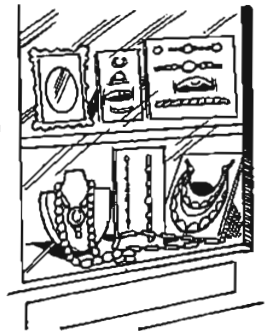

6

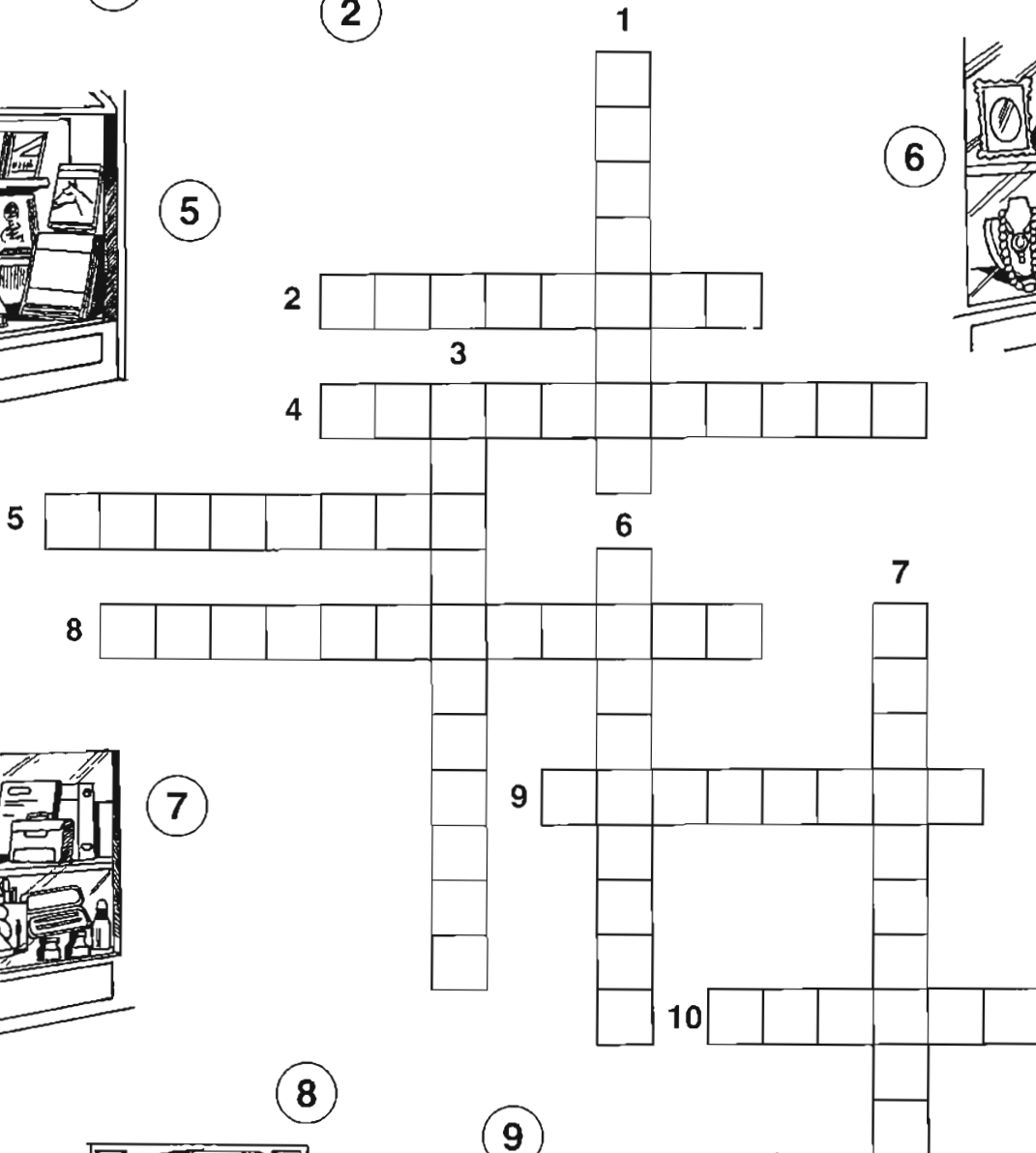

7



8

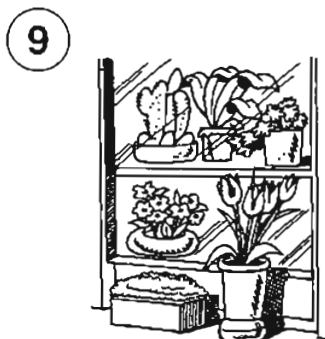

9

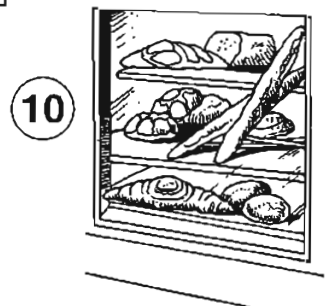

10

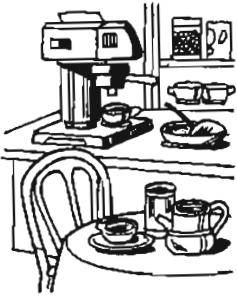

1



2



3



4



5

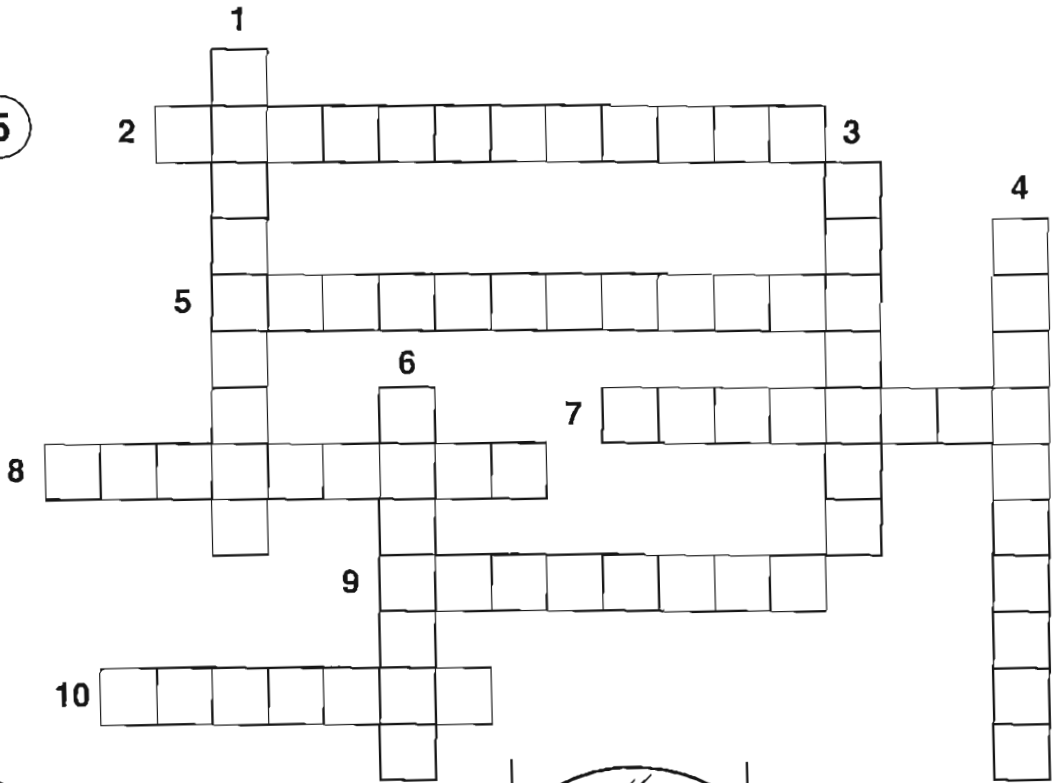

6



7



9



8

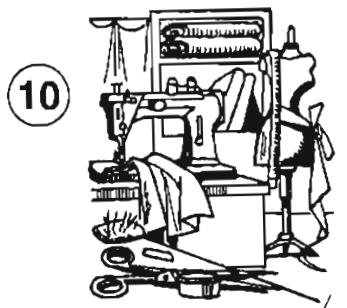

10

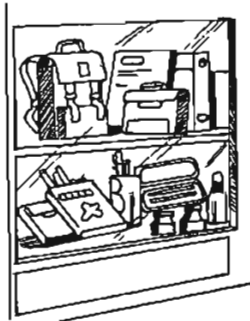
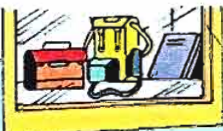

1

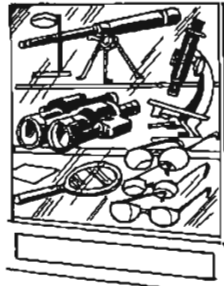

2



3

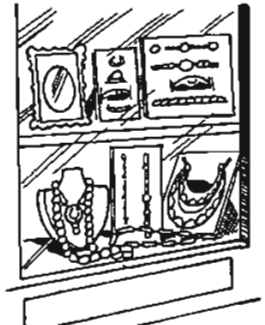

4



5

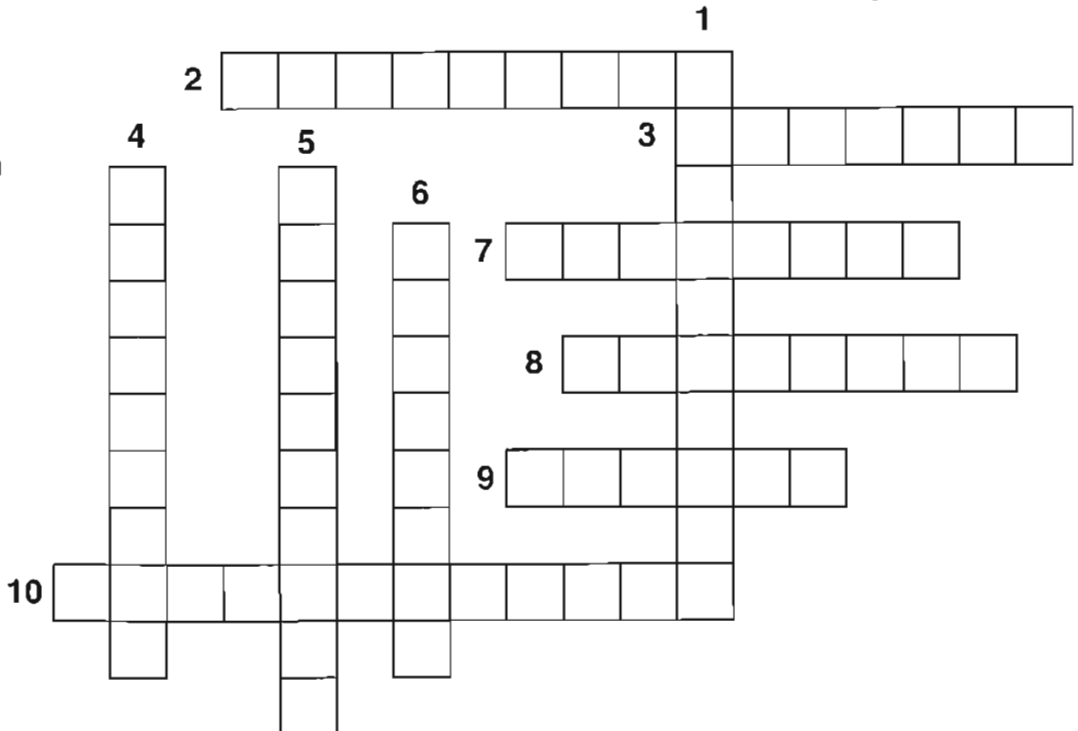

7



9



6



8



10



1



2



3

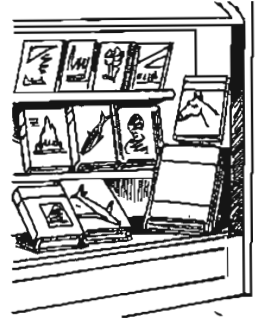

4



5

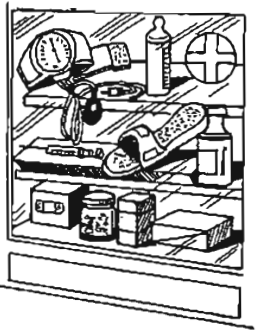

6

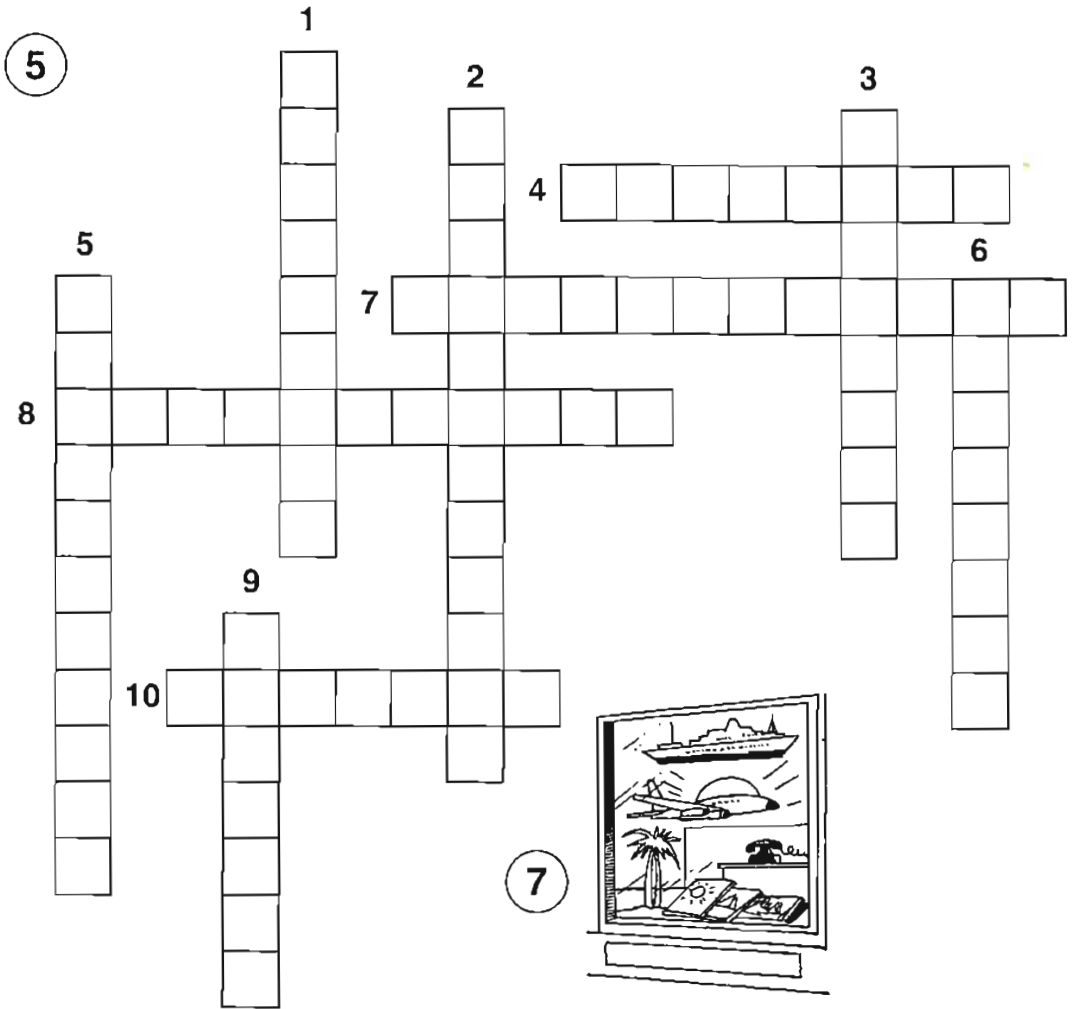

8



9



10

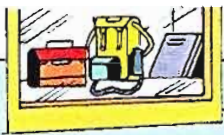

1



2



3



4



5



6

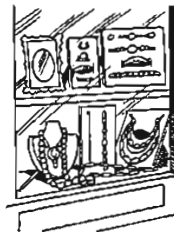
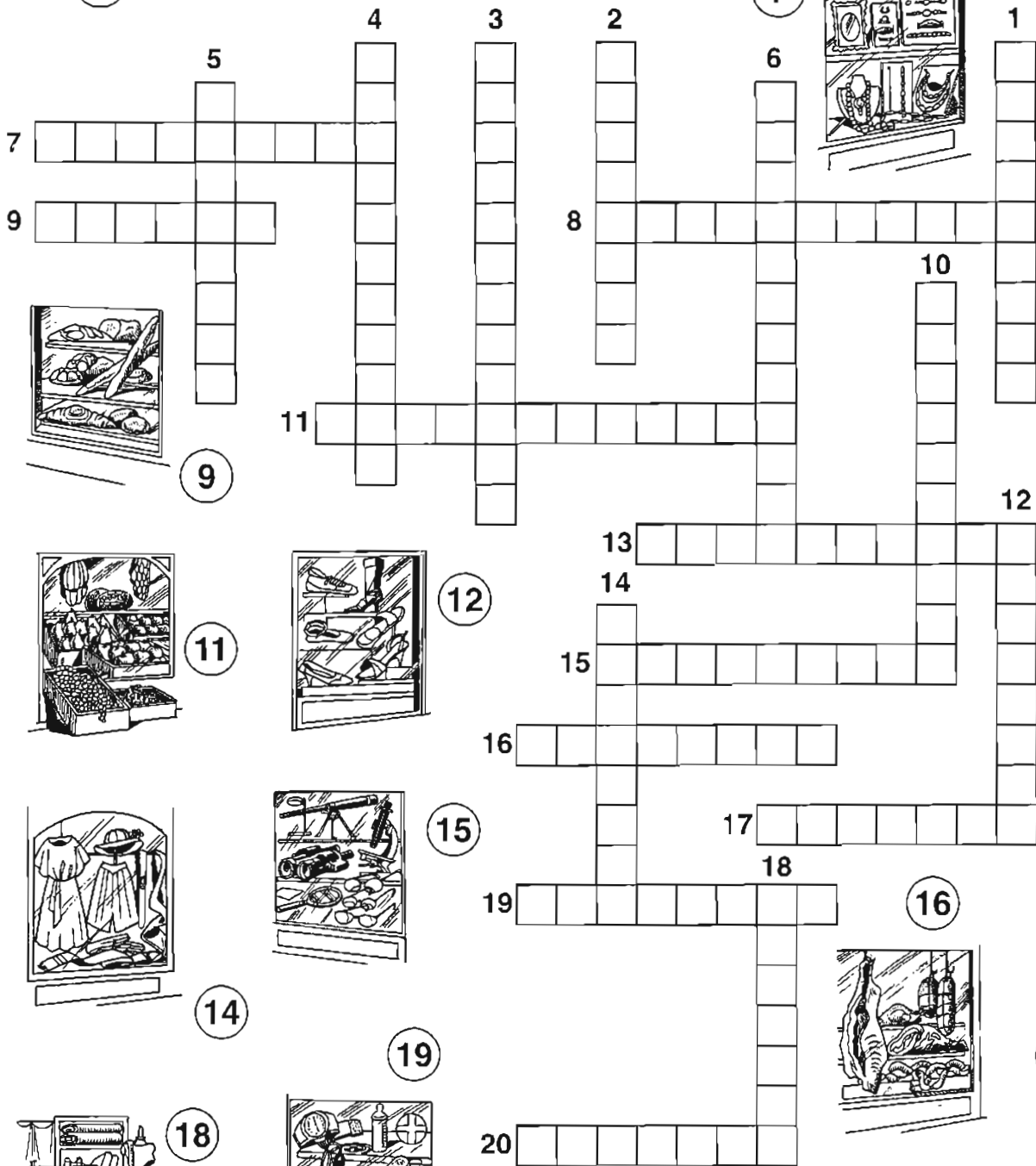

7



8



9



10

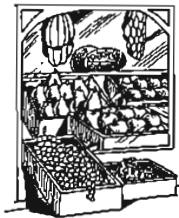

11



12



13



14

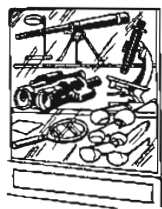

15



16



17



18

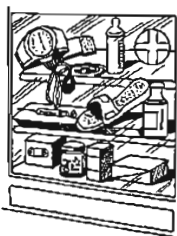

19



20



CONTAINERS



handbag



wallet



purse



suitcase

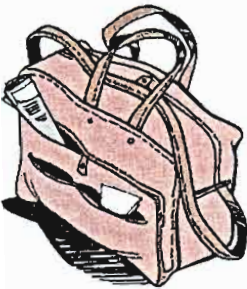

travelbag

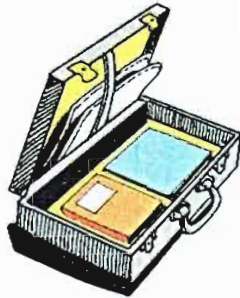

briefcase



rucksack



cage

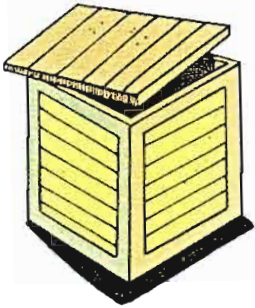

crate



barrel



basket

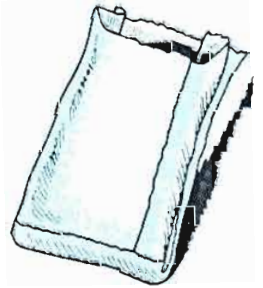

paper bag



bucket

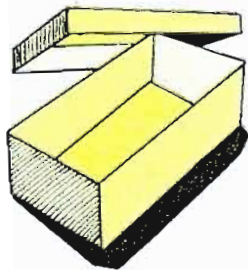

box



petrol can



tin

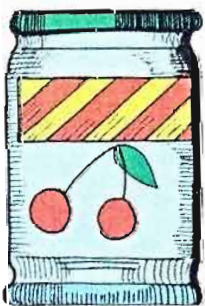

jar



bottle



tube



sack

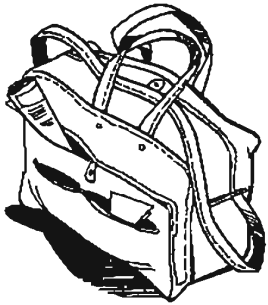
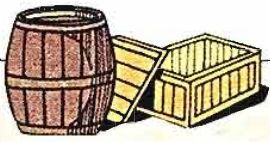

1

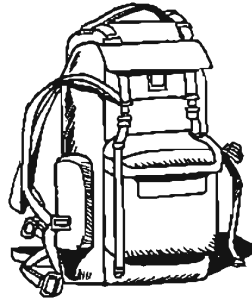

2

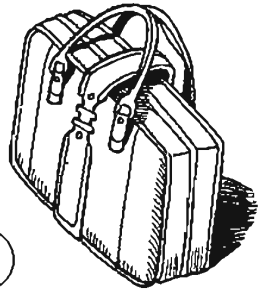

3

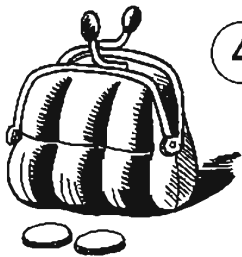
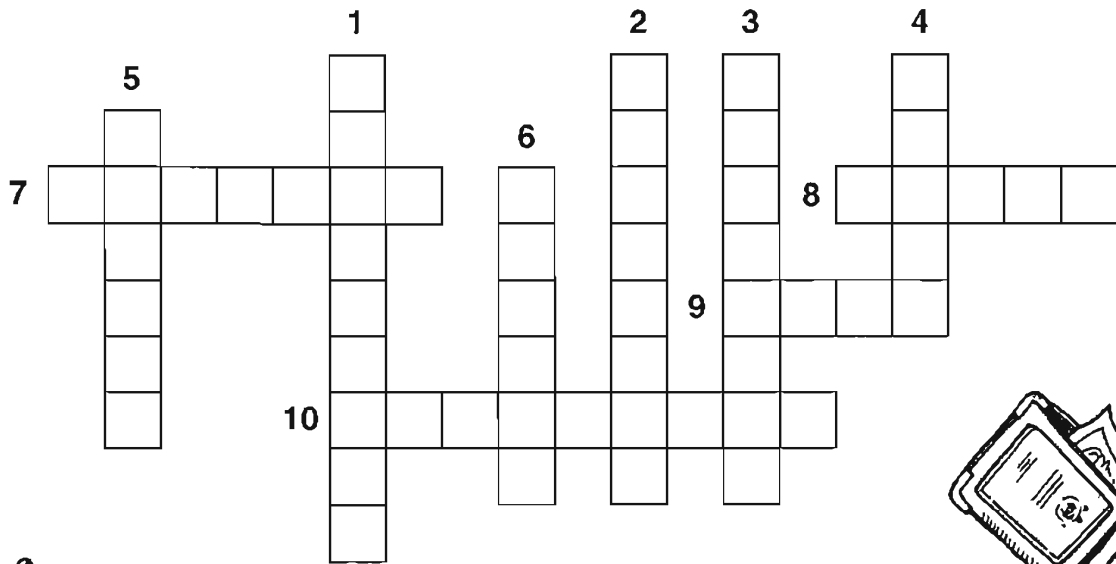

4

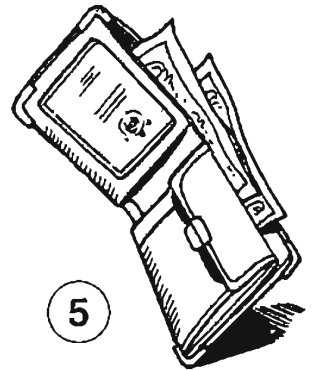

5



7



9

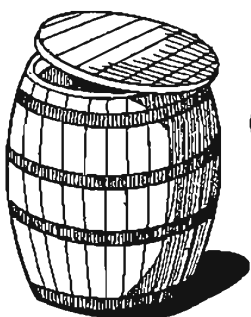

6

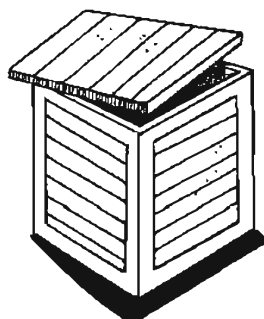

8

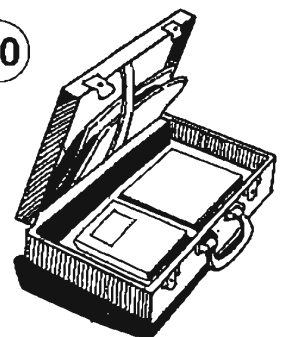

10



1

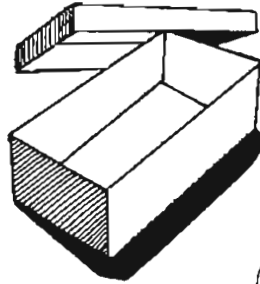

2



3

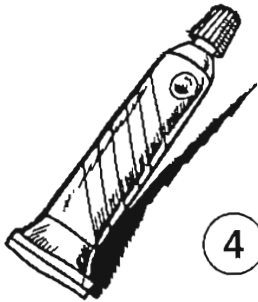

4

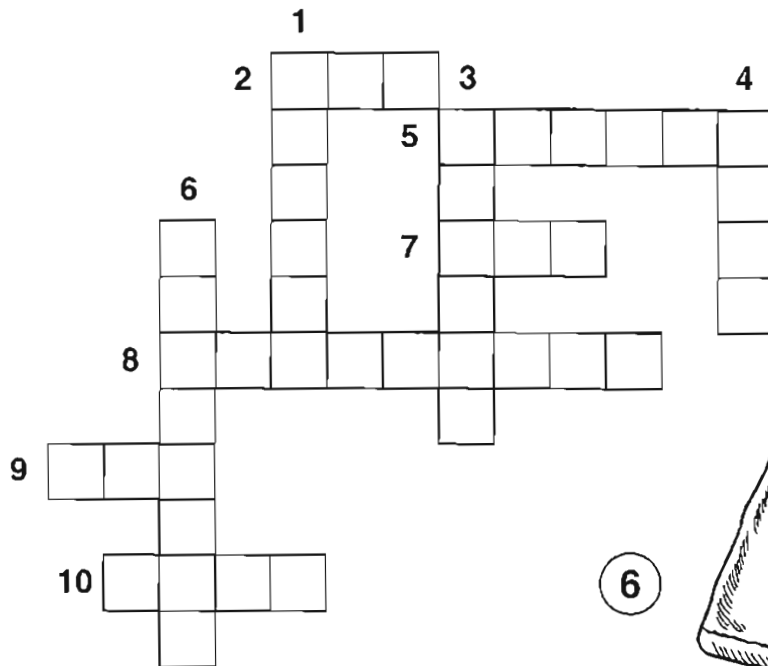

6

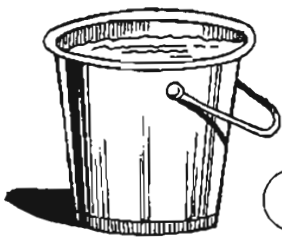

5



8



10

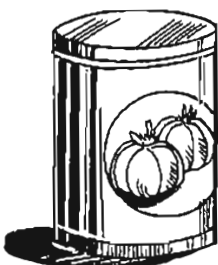

7

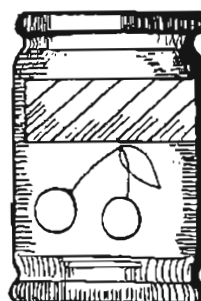

9

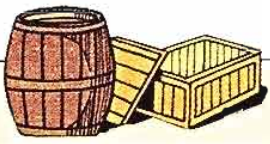

1

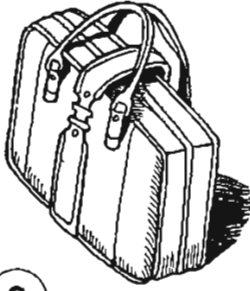

2

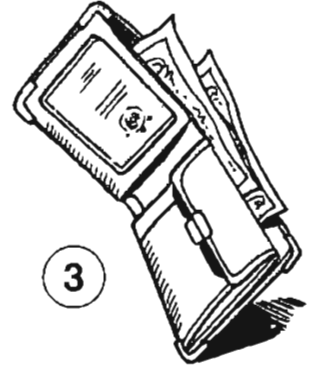

3



4

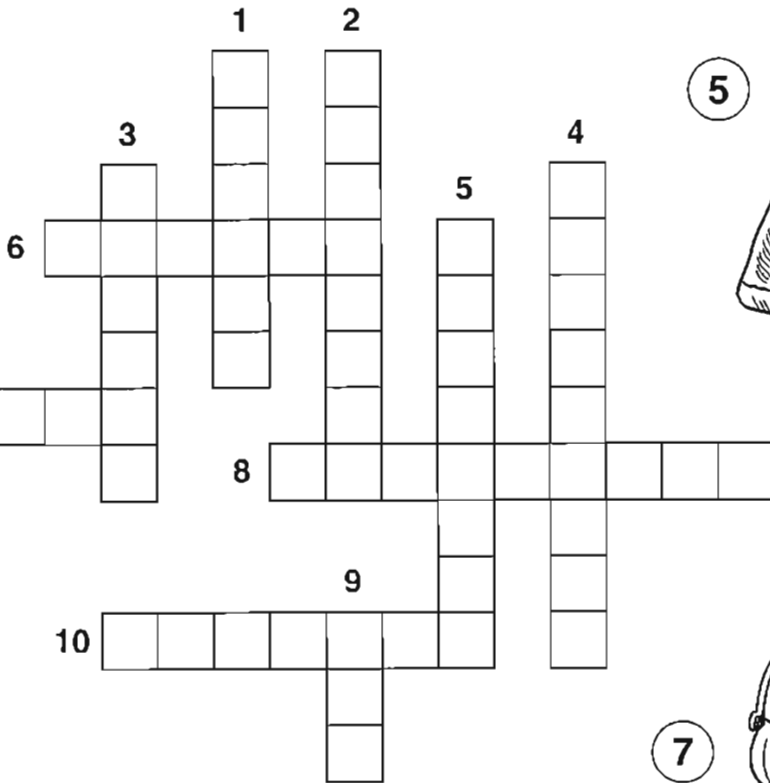

5



6

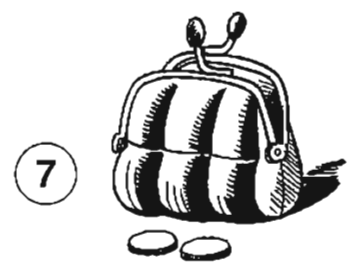

7



8

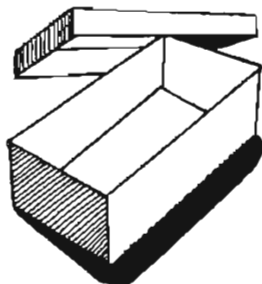

9



10

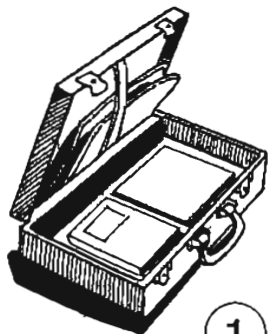
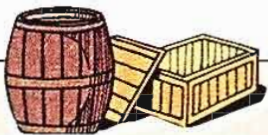

1



2

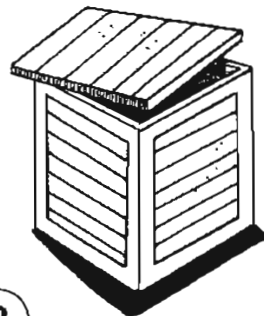

3

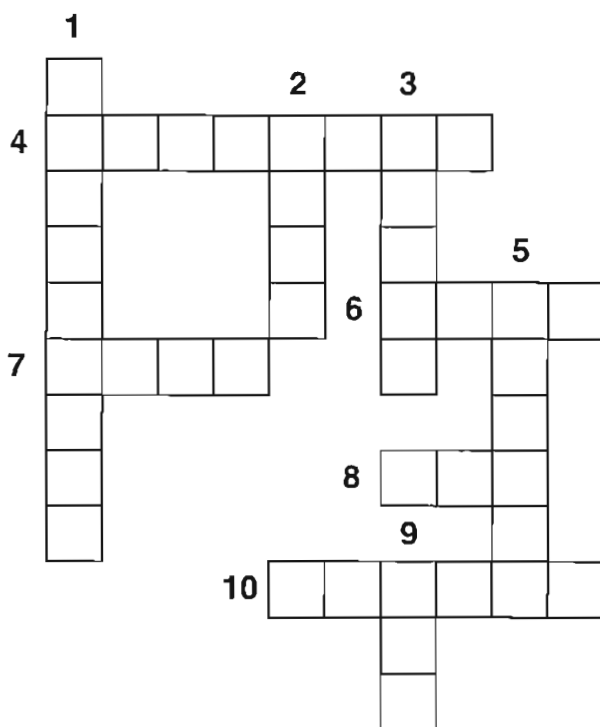

4

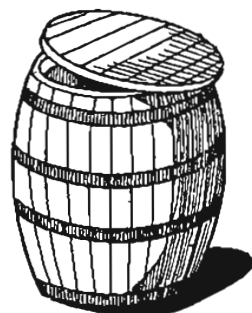

5

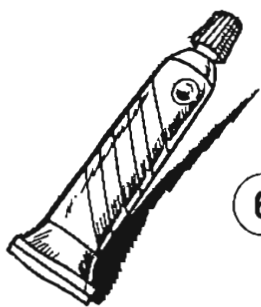

6

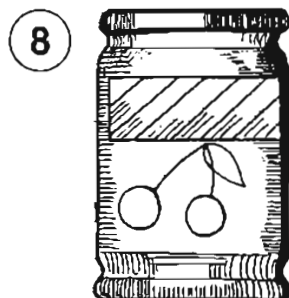

8



10



7

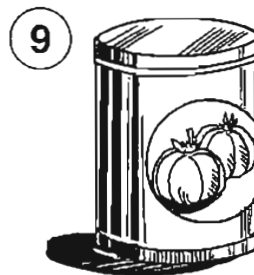

9

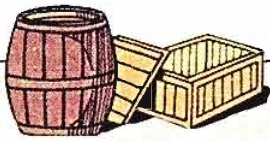

1

2

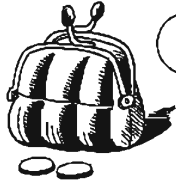

3

4



5

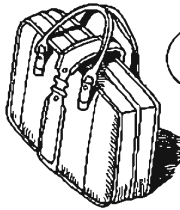

6



7



8

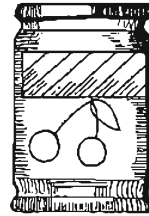

9

10

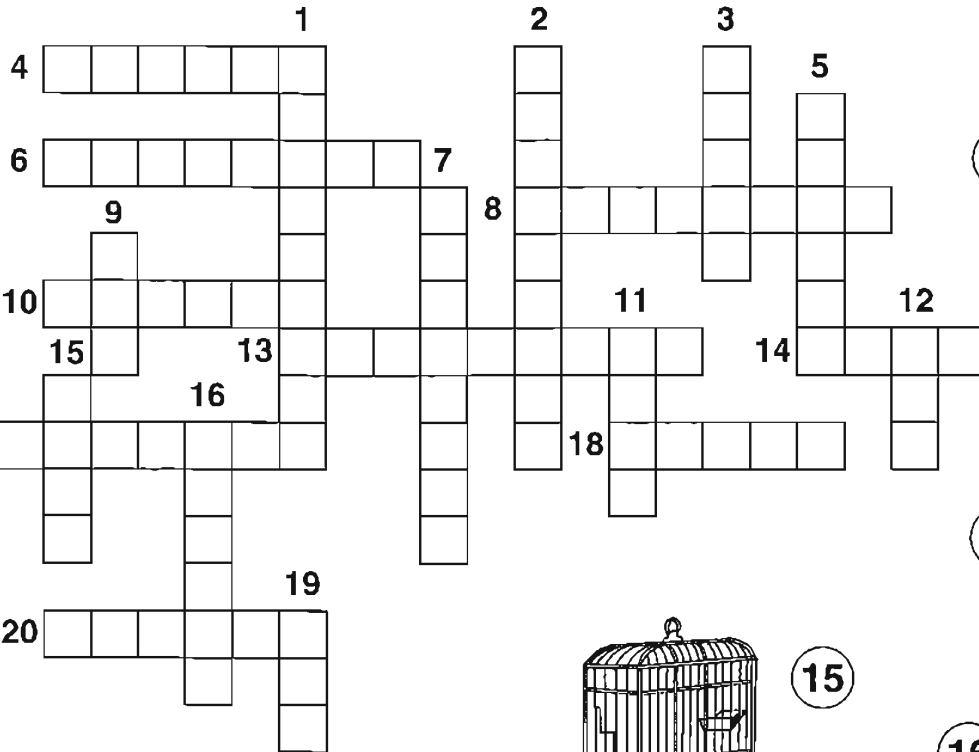
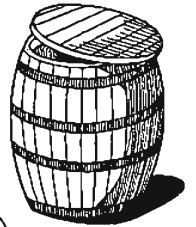

11



12

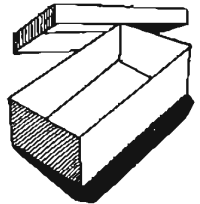

15



16



13

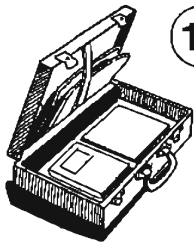

14

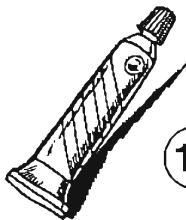

18



19

17

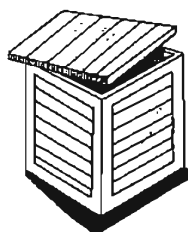

20

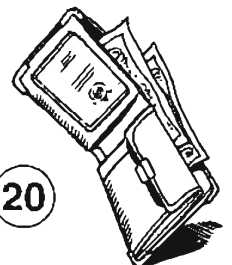

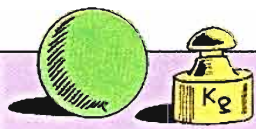

SHAPES, LINES AND MEASURES

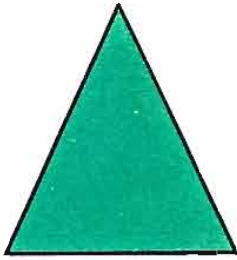

triangle

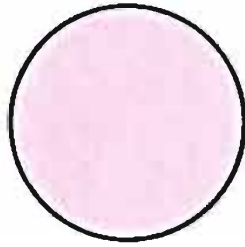

circle



square



rectangle

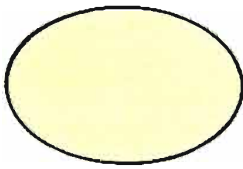

oval

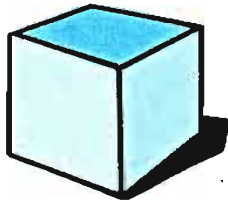

cube

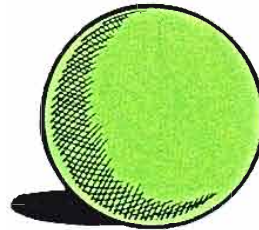

sphere



cone

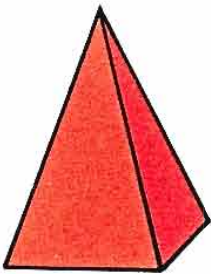

pyramid

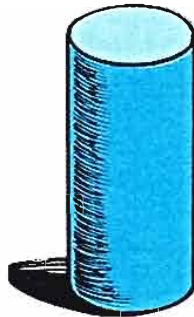

cylinder

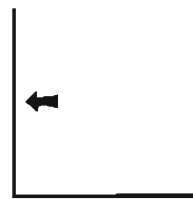

side

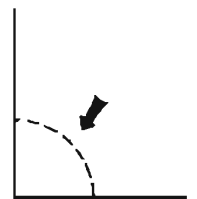

angle

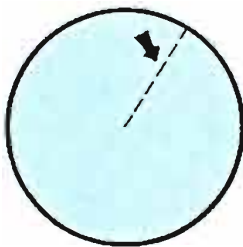

radius

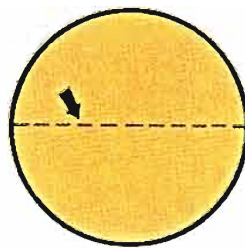

diameter

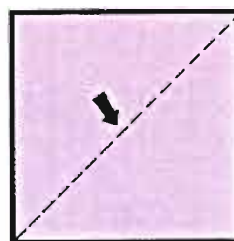

diagonal

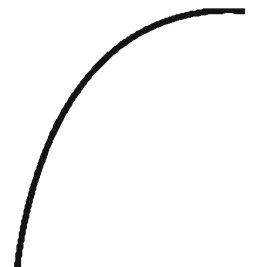

curve

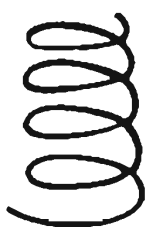

spiral

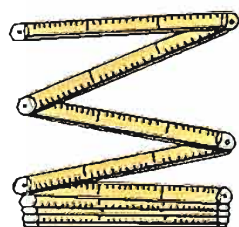

metre



litre



kilo

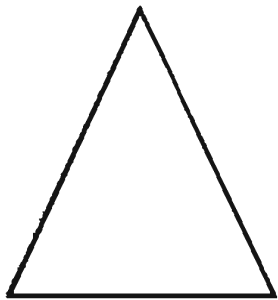

1

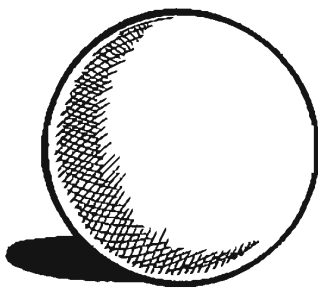

2

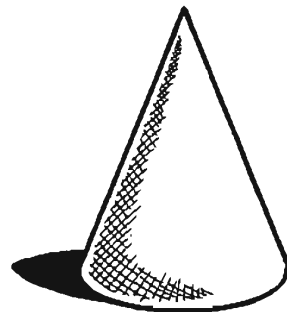

3

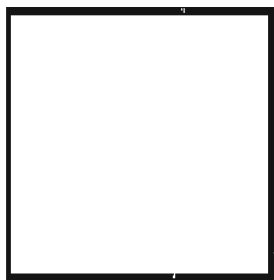

4

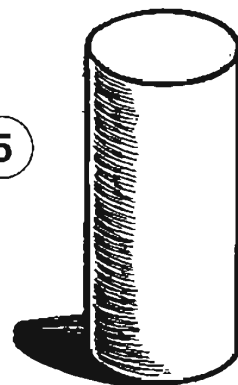

5

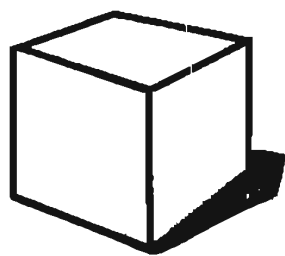
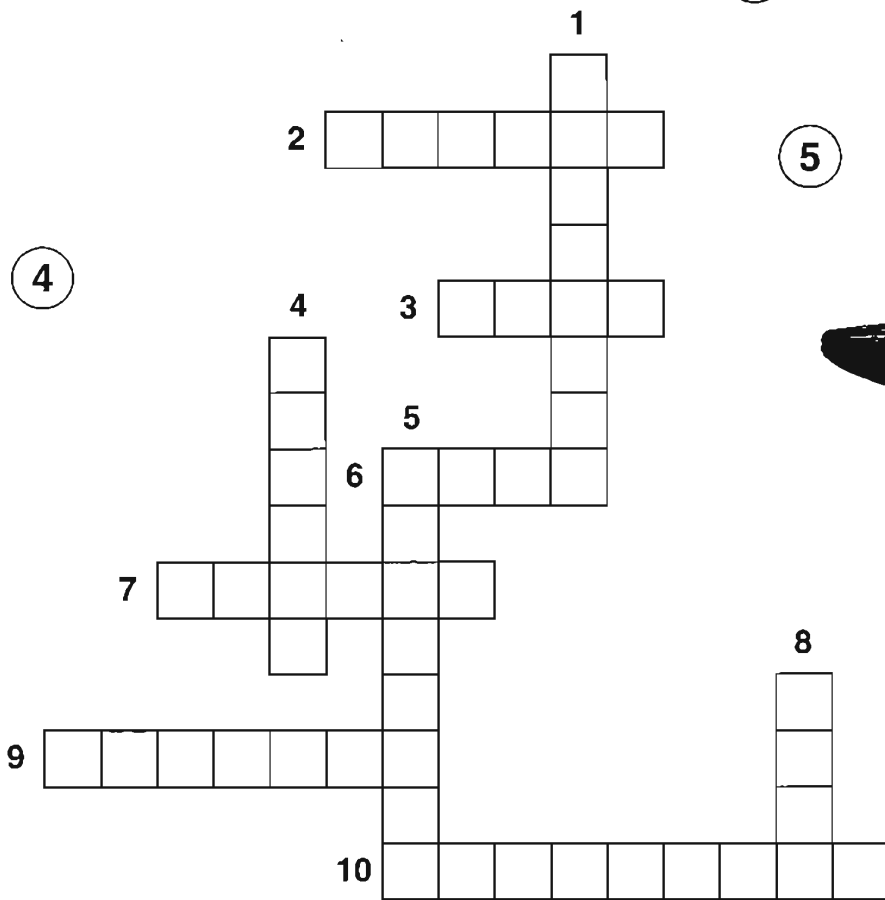

6

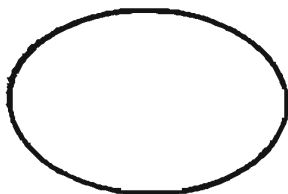

8



10

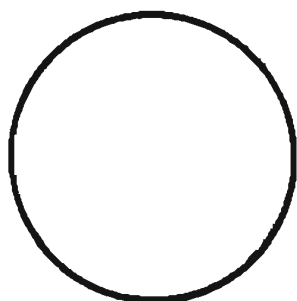

7

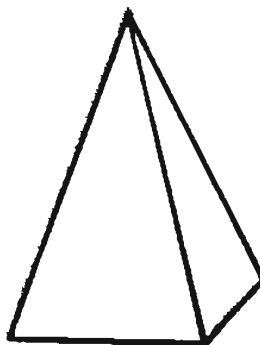

9

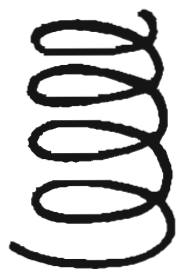

1



2

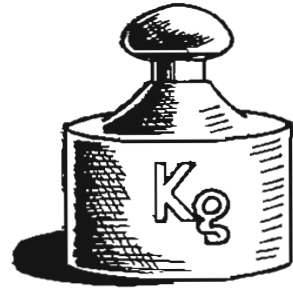

3

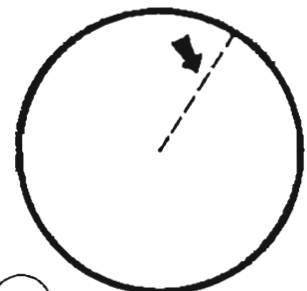

4

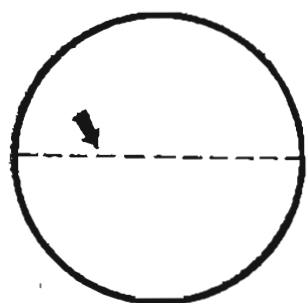

5

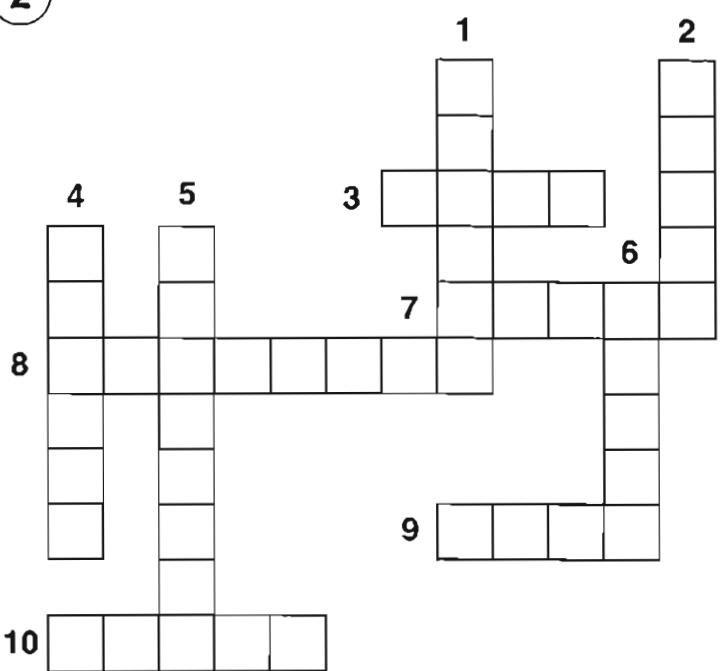

6

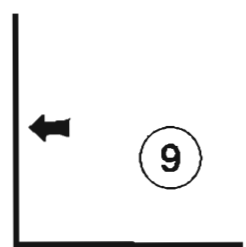

9

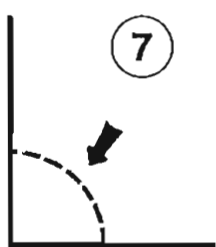

7

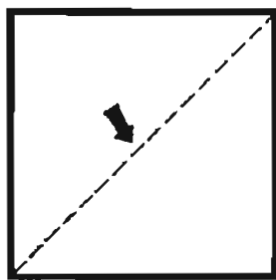

8

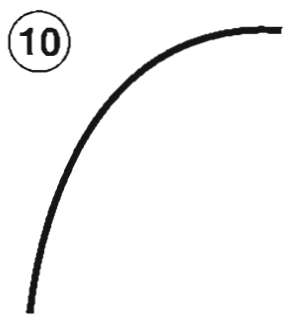

10

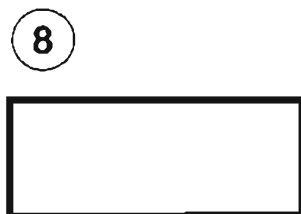
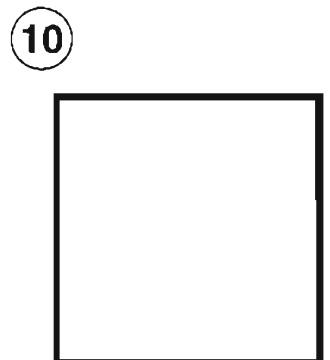
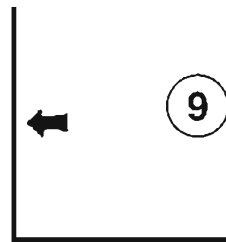
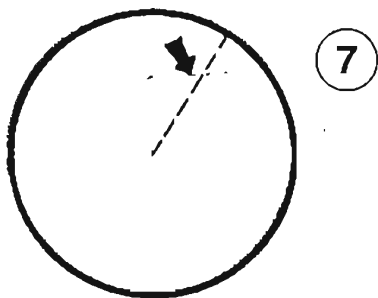
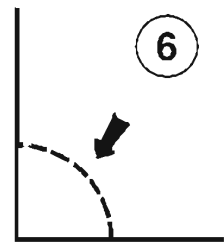
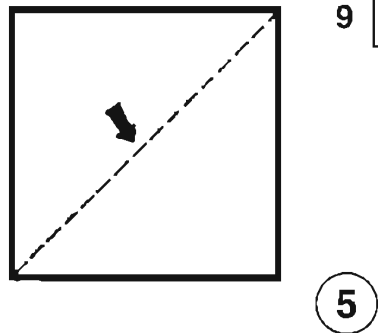
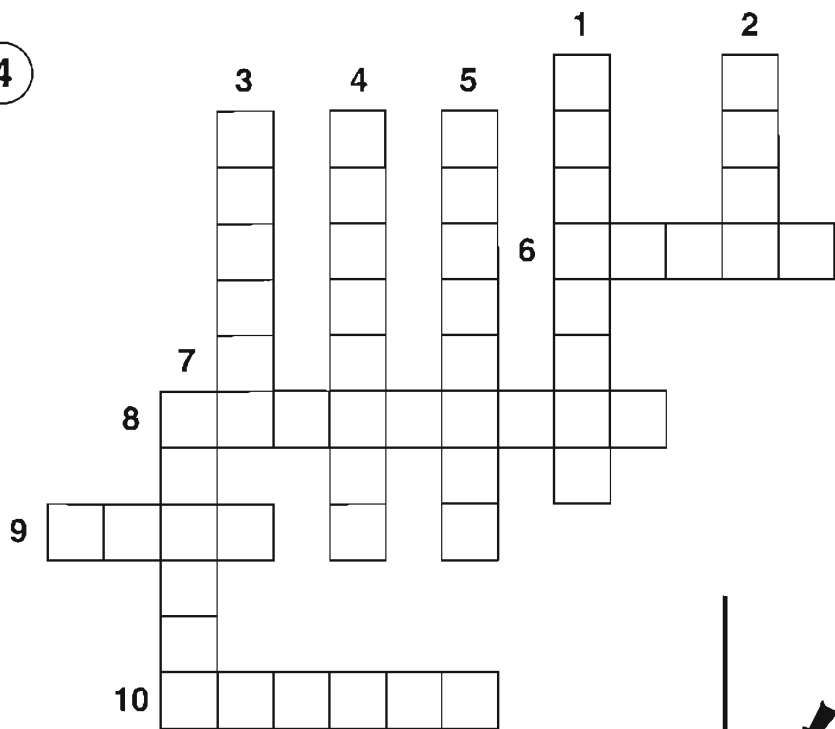
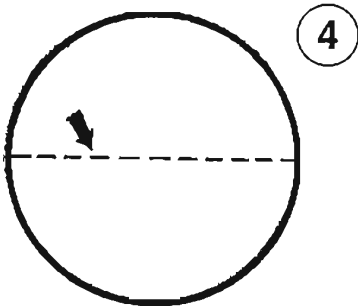
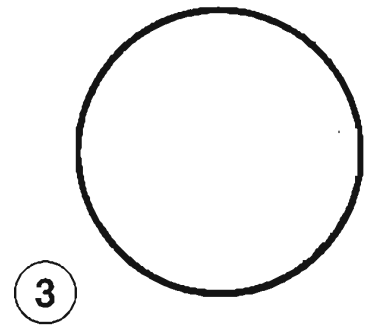
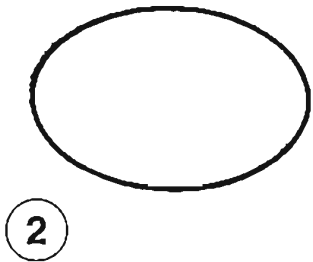
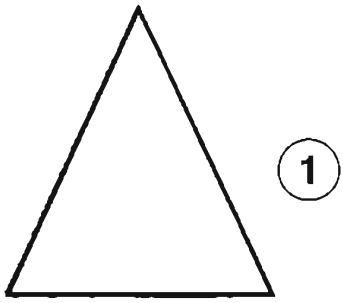

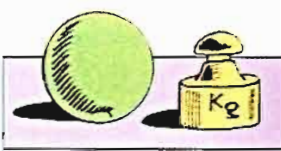

1

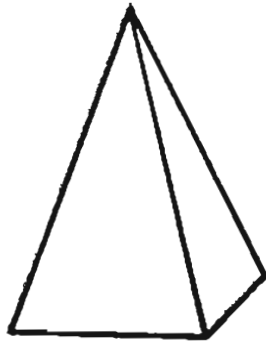

2

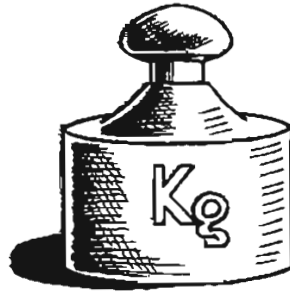

3

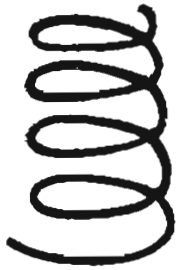

4

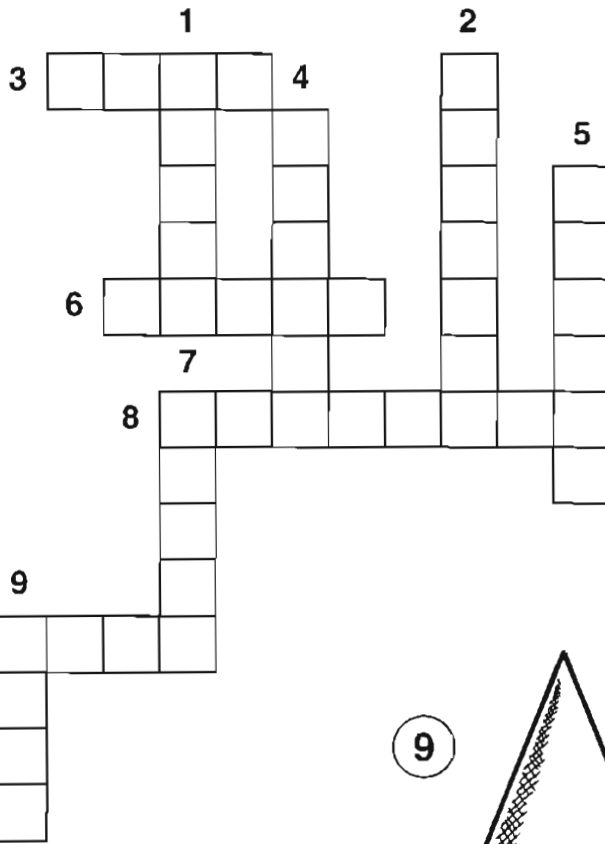

6

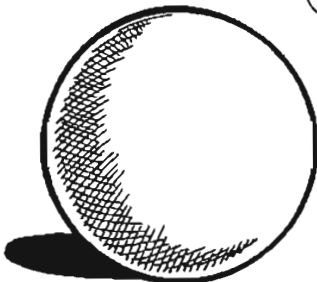

5

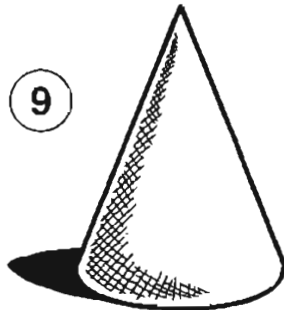

9

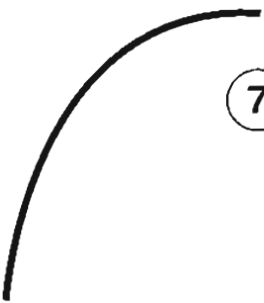

7

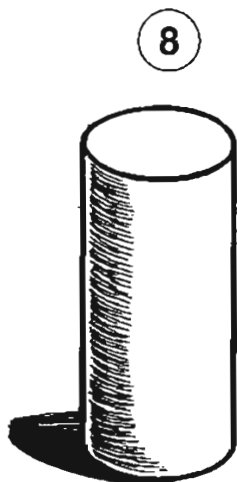

8

10

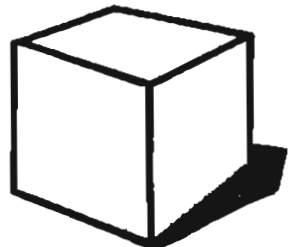

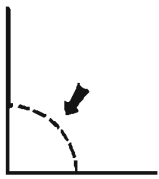
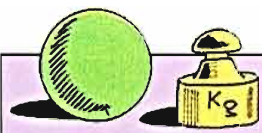

1

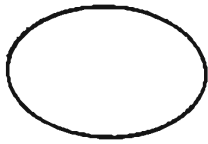

2

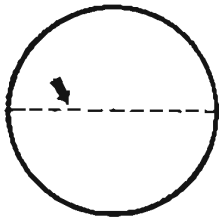

3

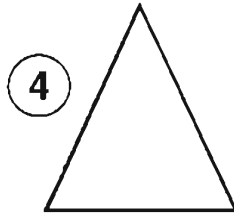

4

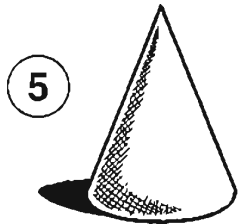

5

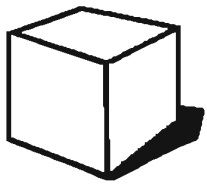

6

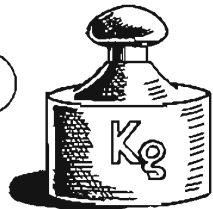
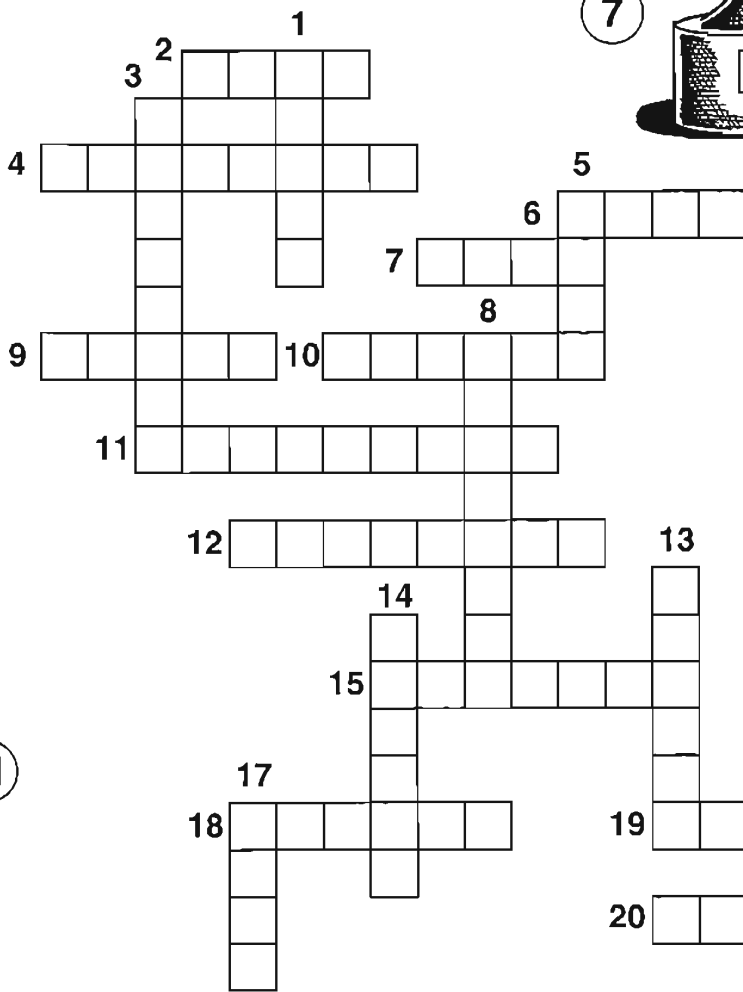

7

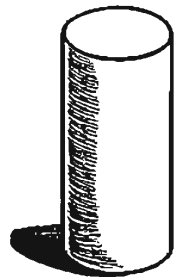

8

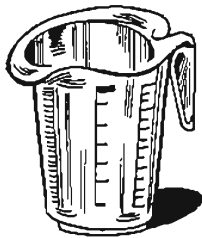

9

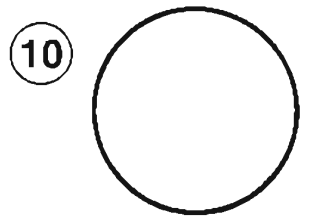

10



11

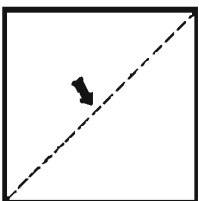

12

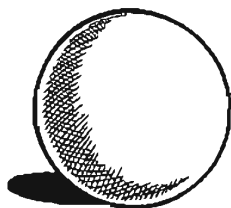

14

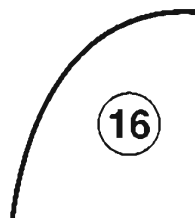

16

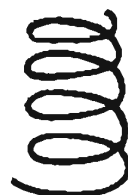

18



20

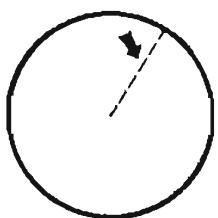

13



15

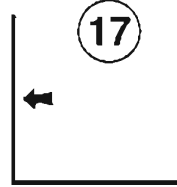

17

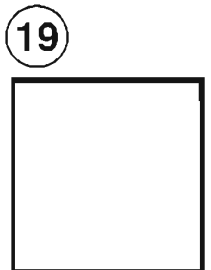

19



MUSIC

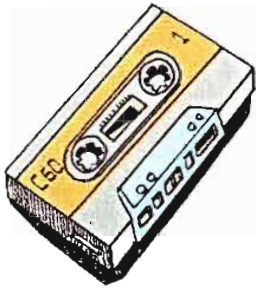

cassette

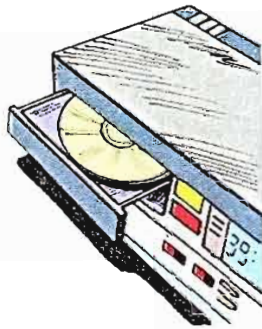

compact disc player



speakers



disc jockey



headphones



il microphone



singer

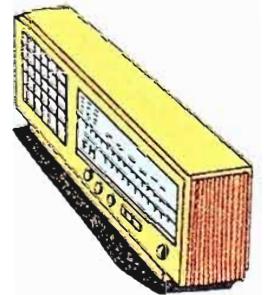

radio

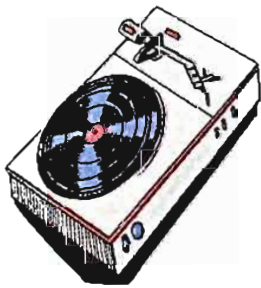

record player

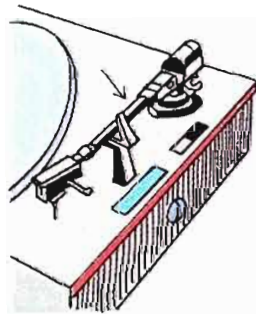

arm

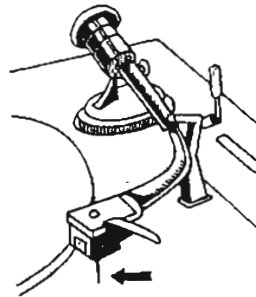

stylus



record



sleeve



sheet music



musical notes

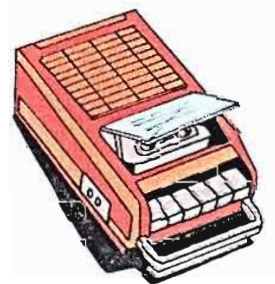

cassette player



conductor



musicians



musical instruments



backing singers



1

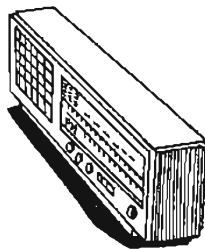

2



3



4



5

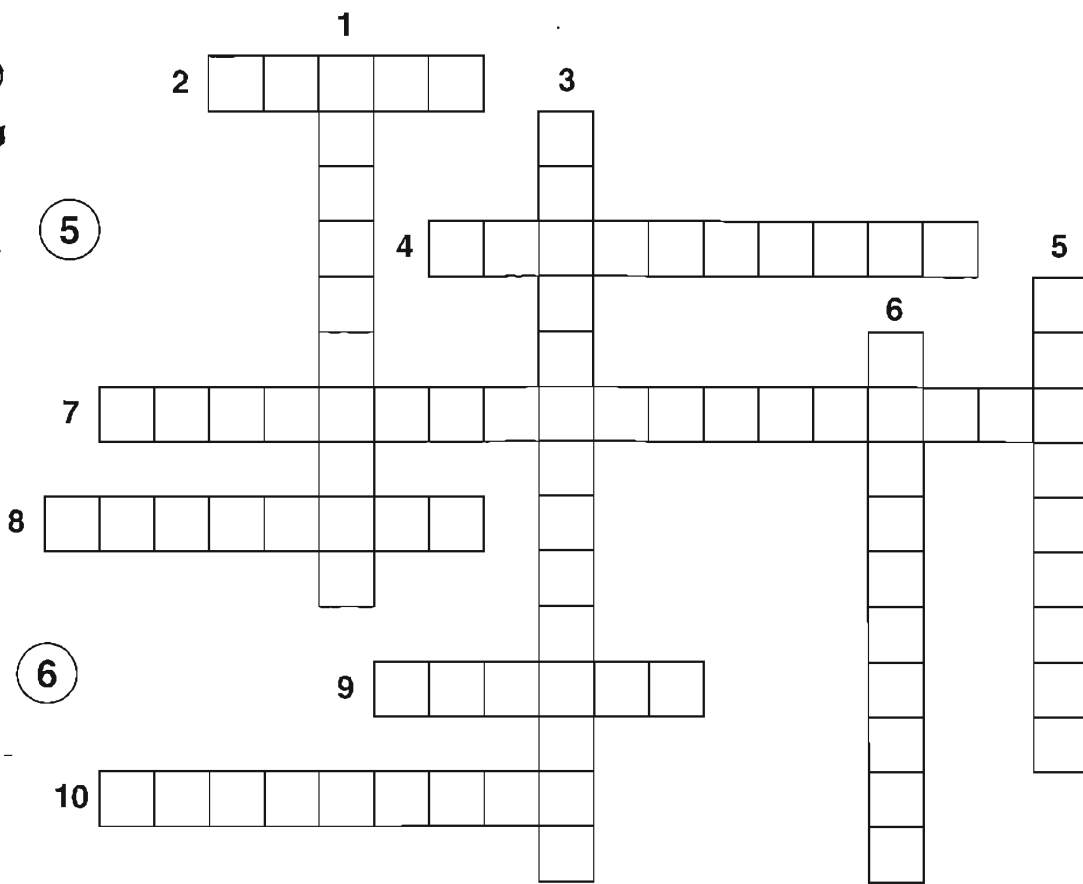

6



7

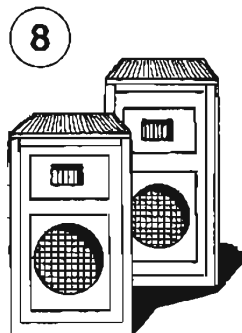

8

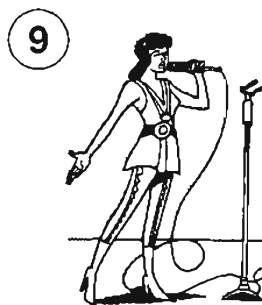

9



10



1

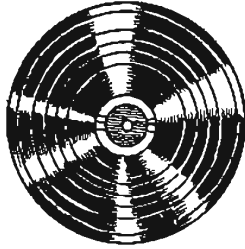

2



3

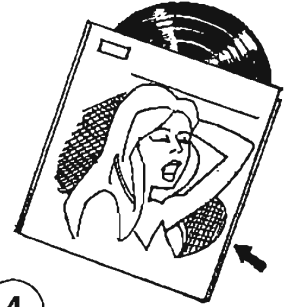

4

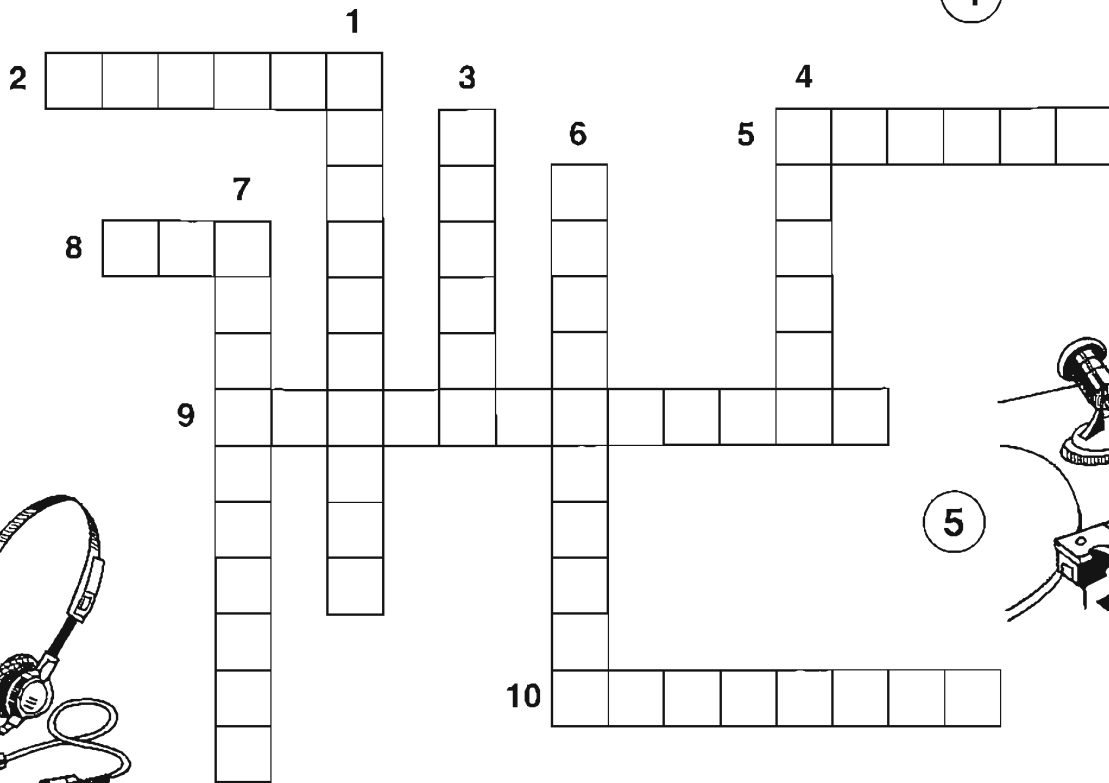

6

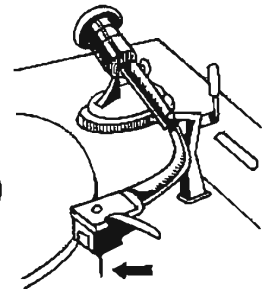

5



7

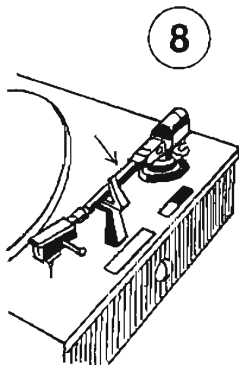

8

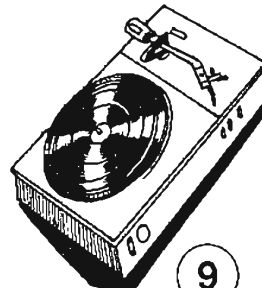

9

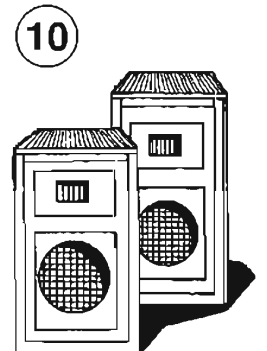

10



1

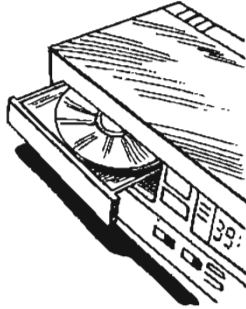

2



3



4

5

1

6

2

3

4

7

8

9

10

5



6



7



8



9

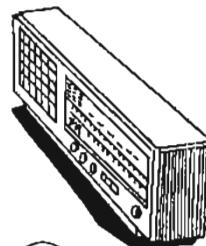

10

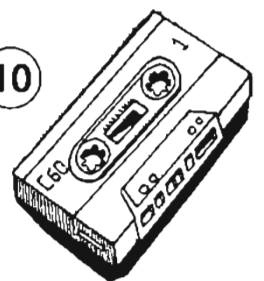

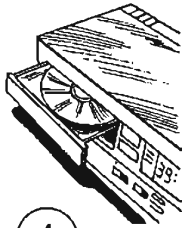
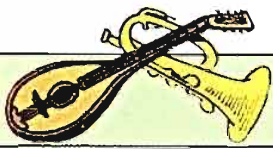

1

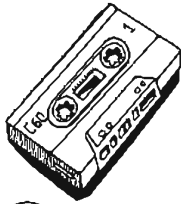

2



3

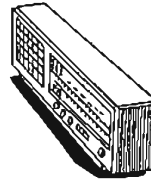

4



5

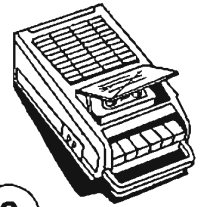

6

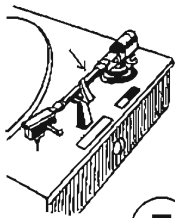

7



8



9



10

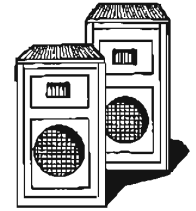

11

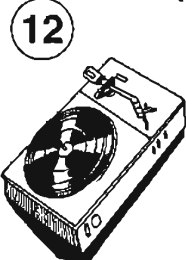
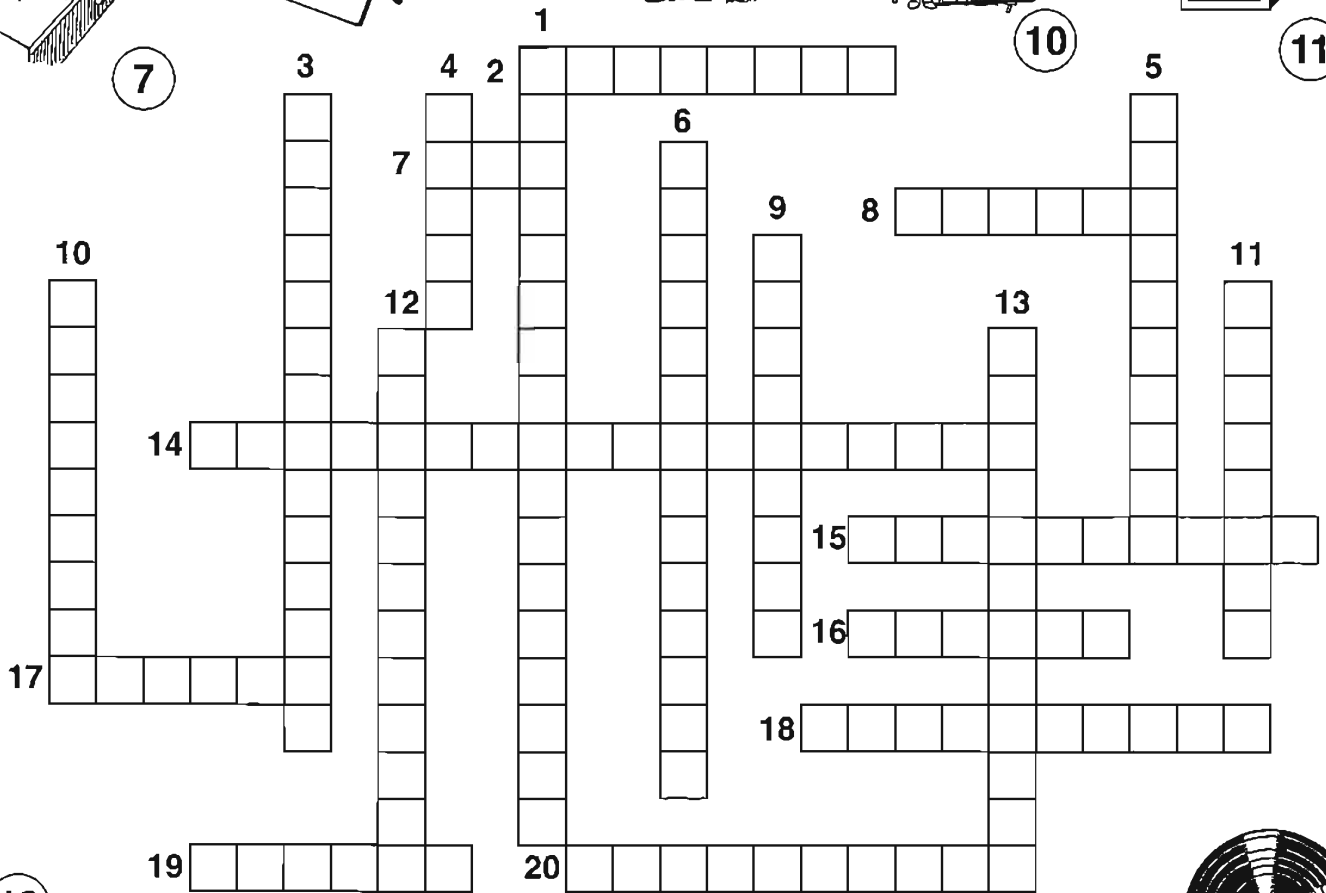

12



14

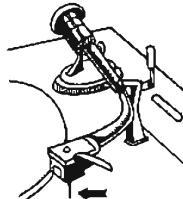

16



18

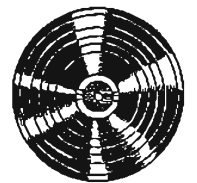

19



13



15



17



20



AT THE THEATRE



box office



ticket

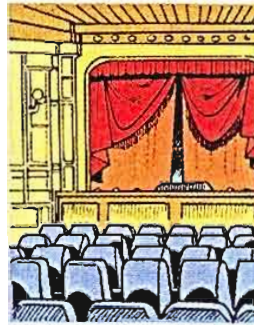

auditorium

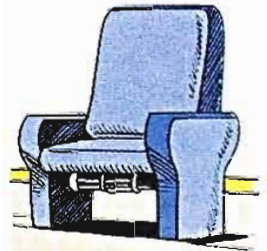

seat



actor



actress



audience



costumes



make-up artist



costume designer



director



playwright



prompter



composer

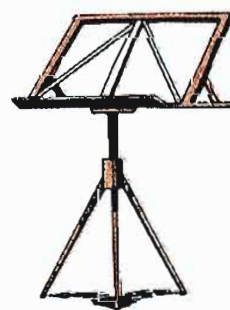

music stand

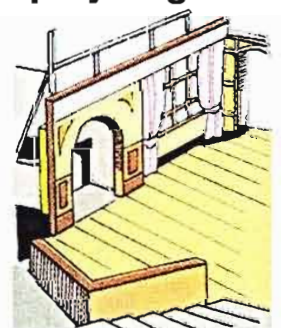

set

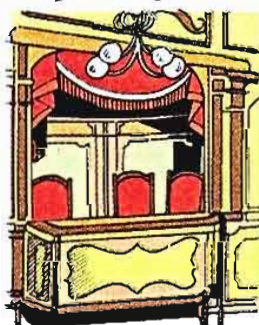

box

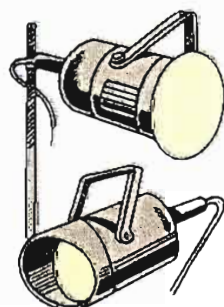

stage lights



curtain



stage



1

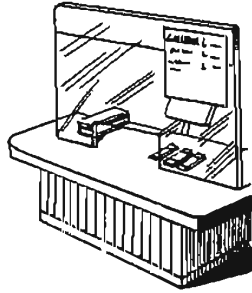

2

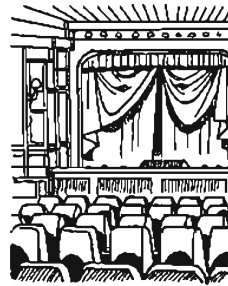

3



4

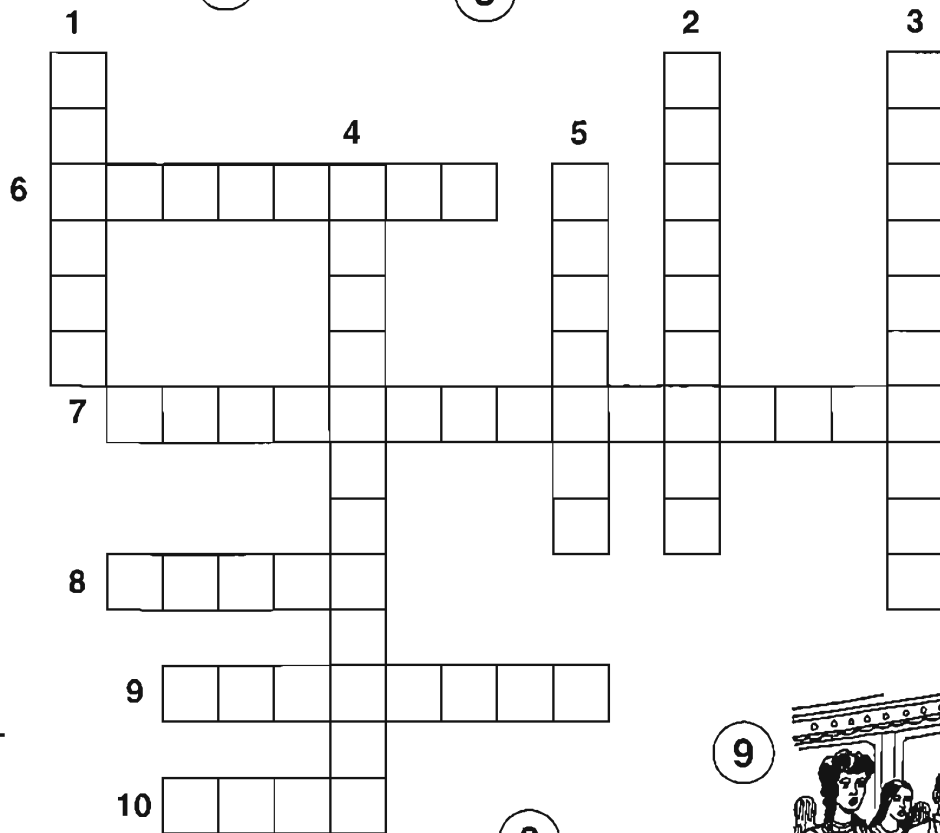

5

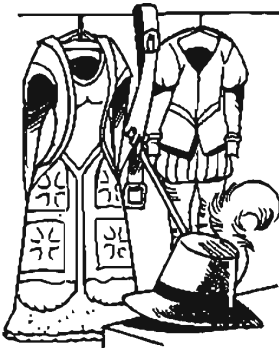

6



7

8



9



10

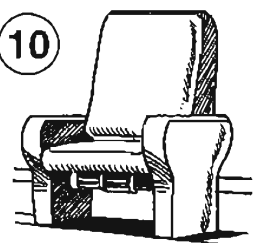



1



2



3

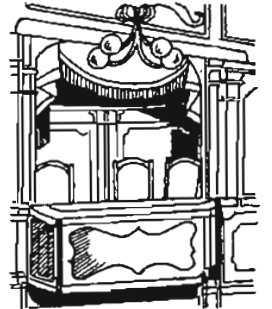

4



5



6

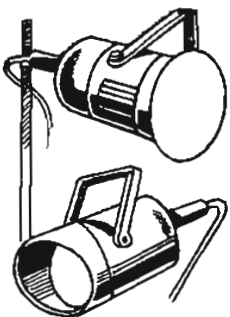
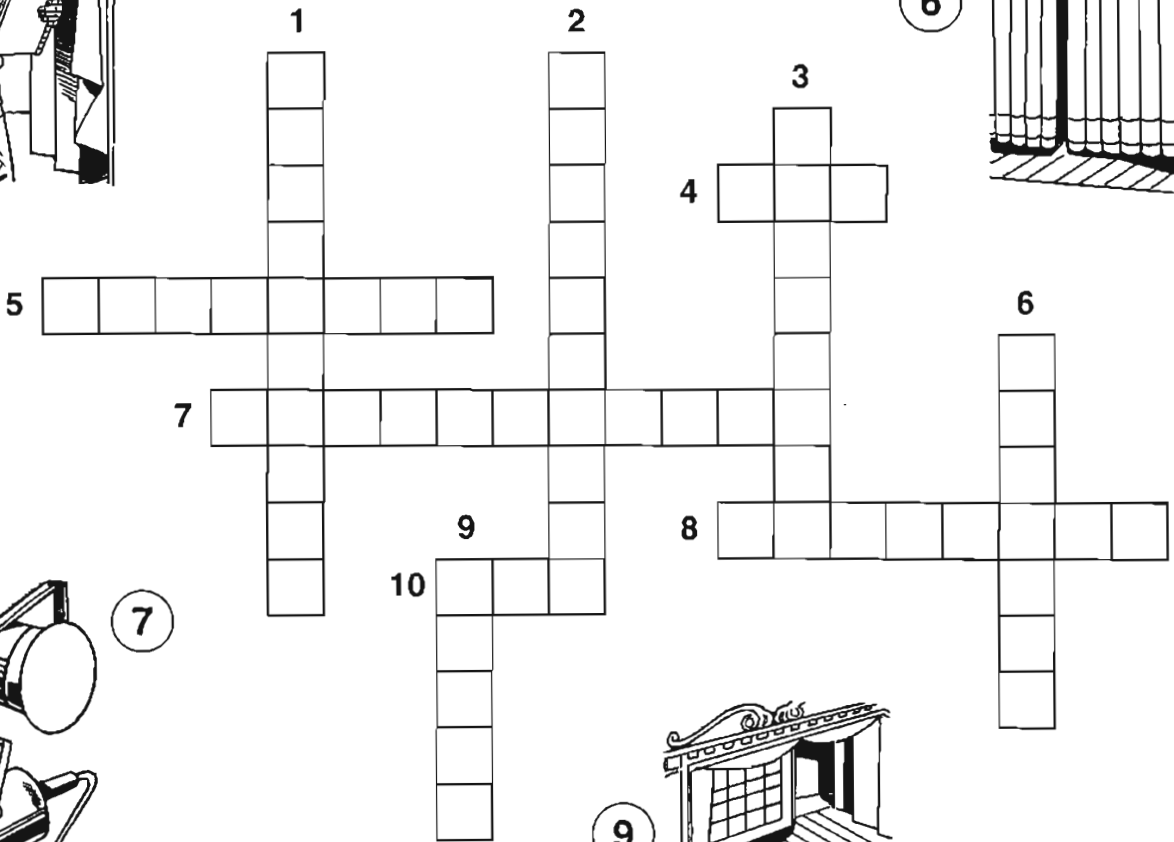

7



9



8

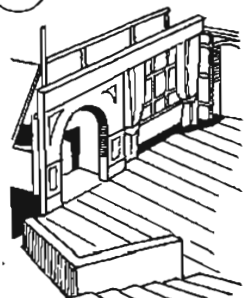

10

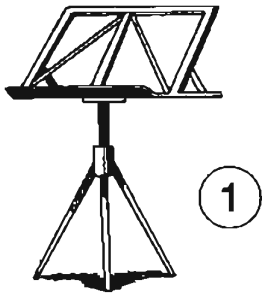

1



2

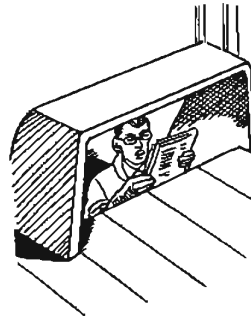

3

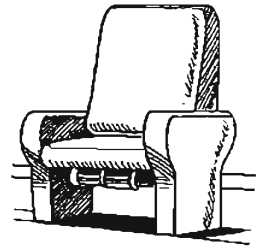

4

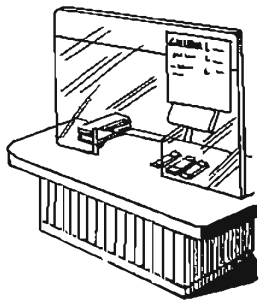

5



6

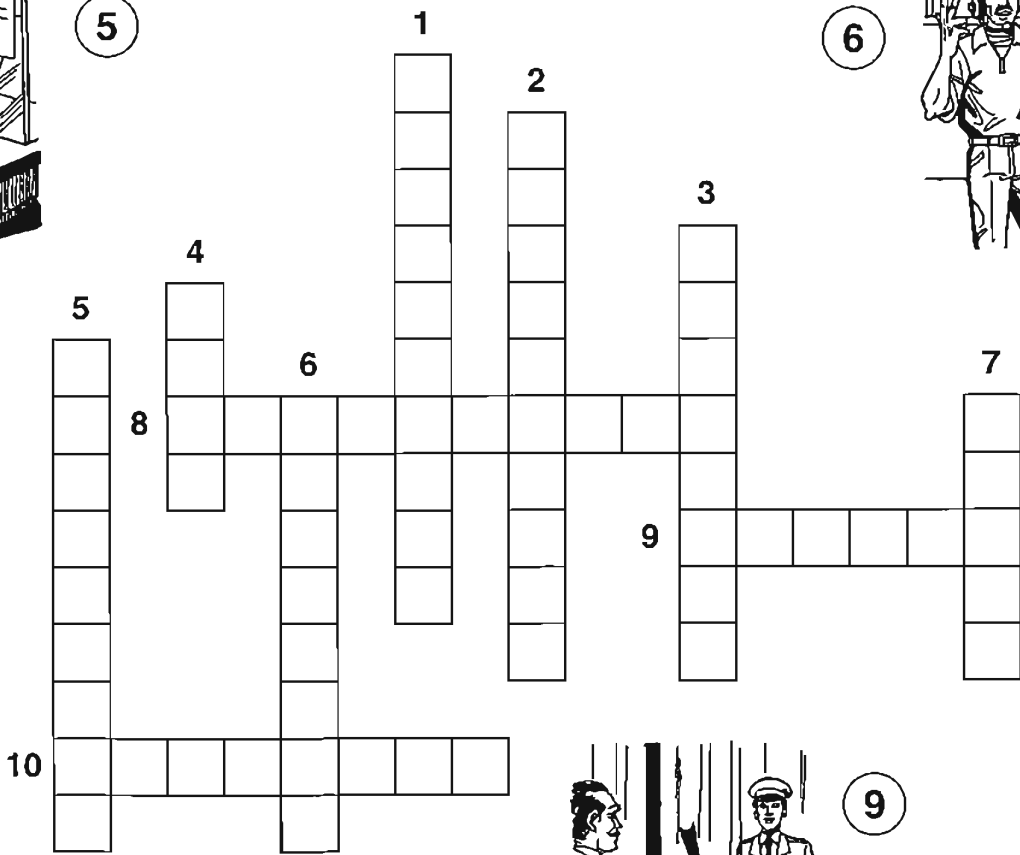

7



9

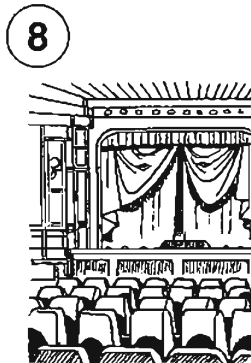

8



10



1



2

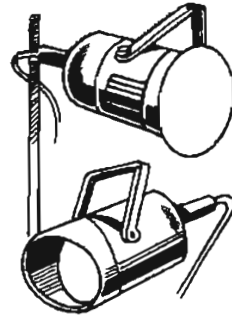

3



4



5



6



7

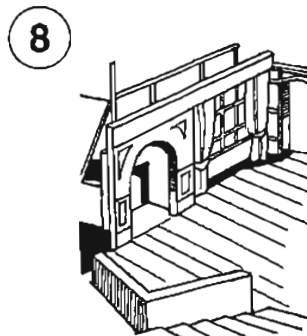

8



9

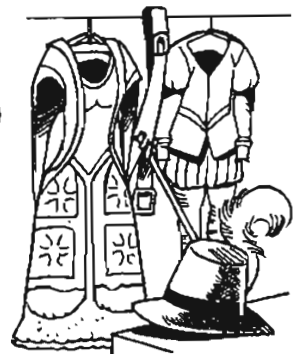

10

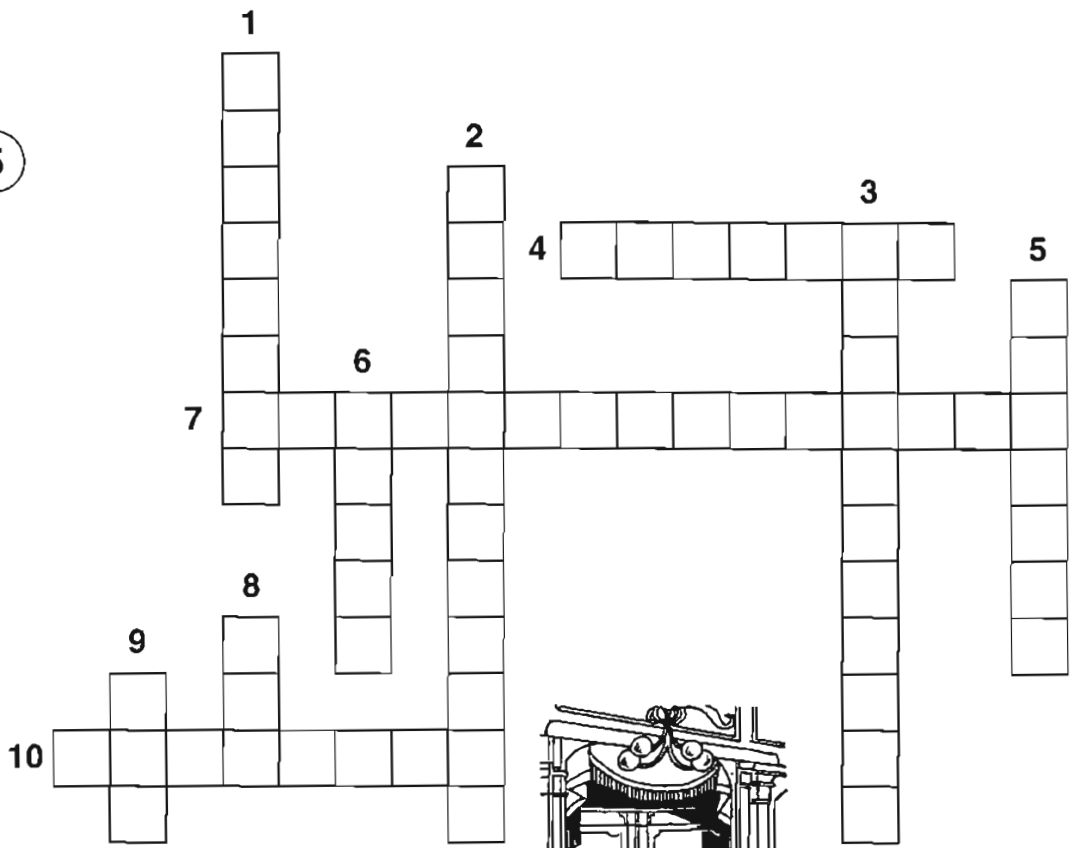

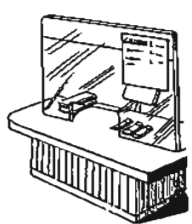

1

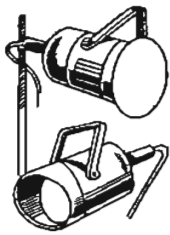

2



3



4



5

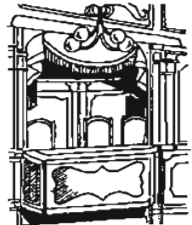

6



7



8

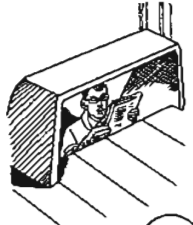

9



10

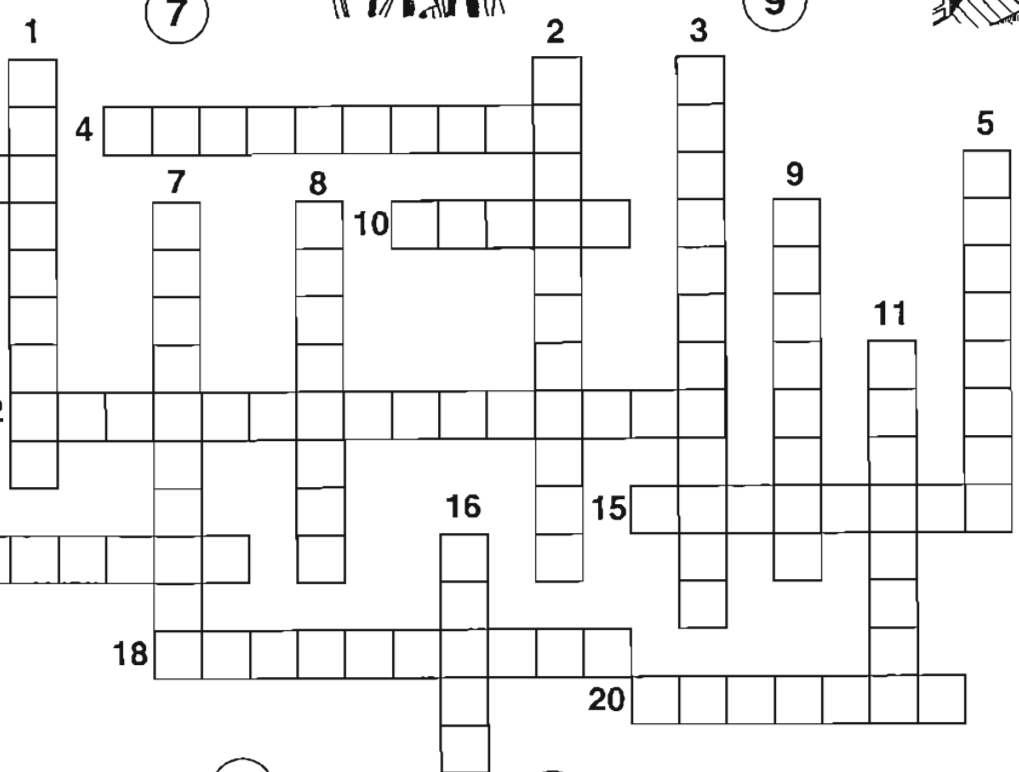

11



12



13

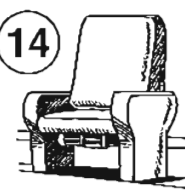

14



15



16



17

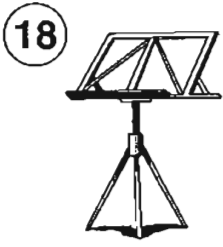

18

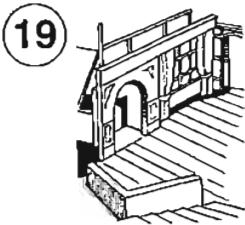

19



20



SPORTS EQUIPMENT



roller skates

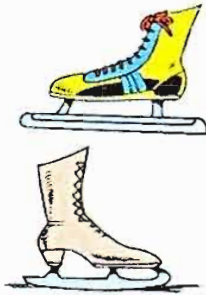

ice skates



football boots

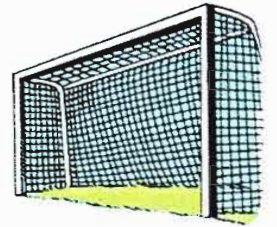

goal



football

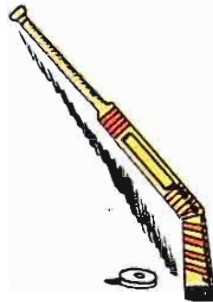

ice hockey stick

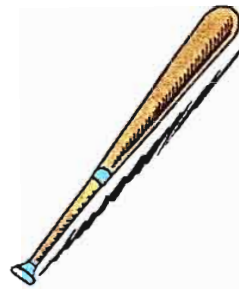

baseball bat



glove



tennis racket

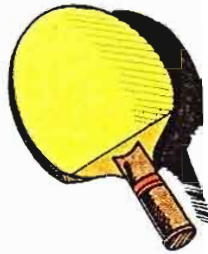
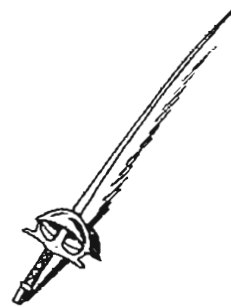
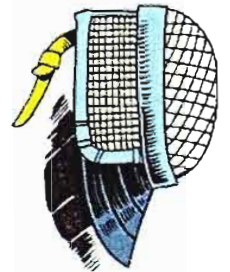

table tennis bat



foil



fencing mask

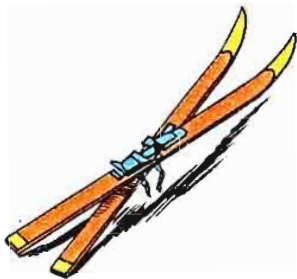

skis

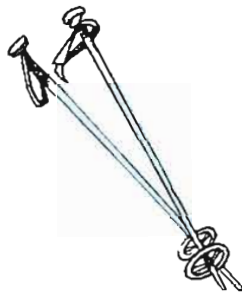

skisticks



crash helmet

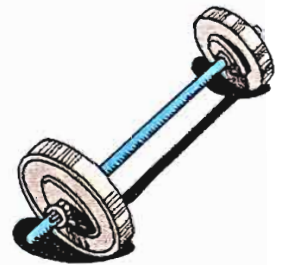

weight



boxing gloves

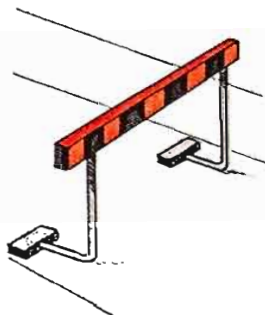

hurdle



flippers



diving mask

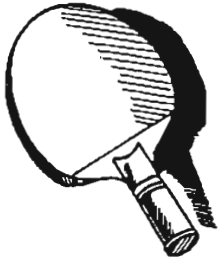
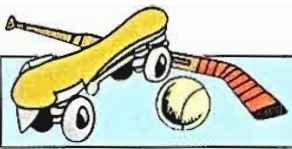

1

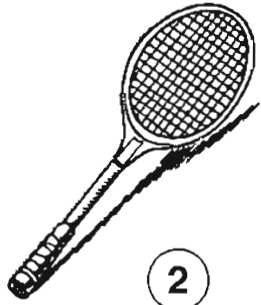

2



3

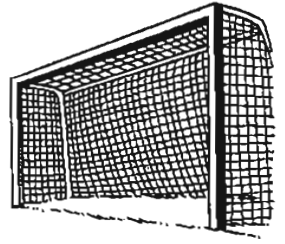

4



5

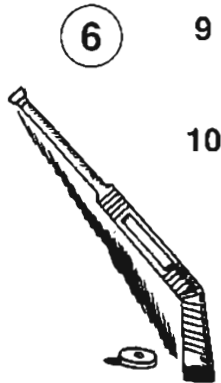
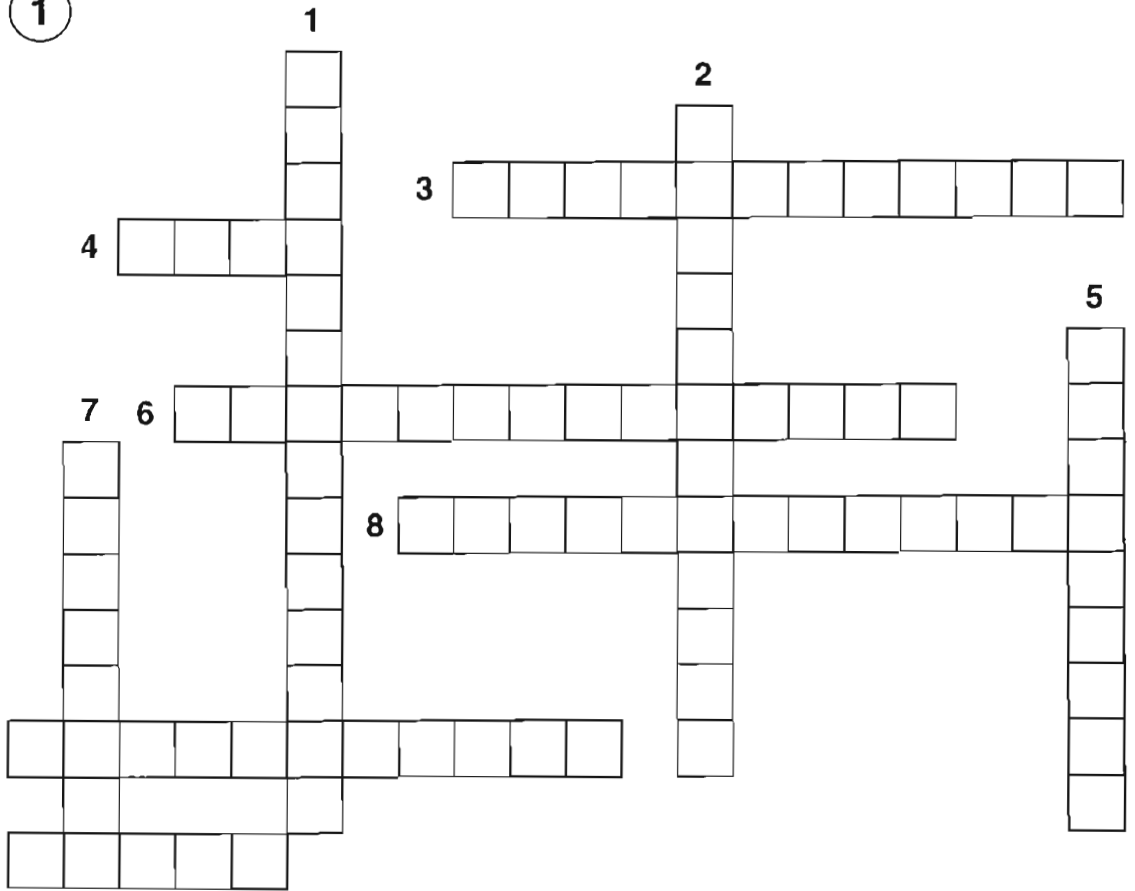

6



8



10



7

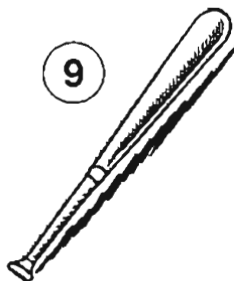

9

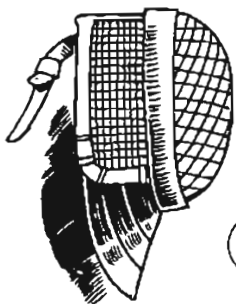

1



2

3

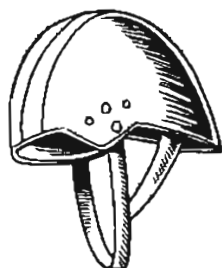
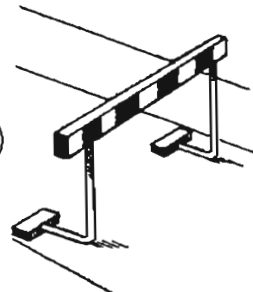

4

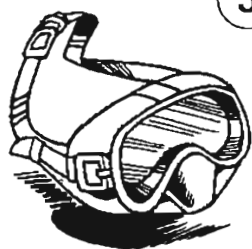
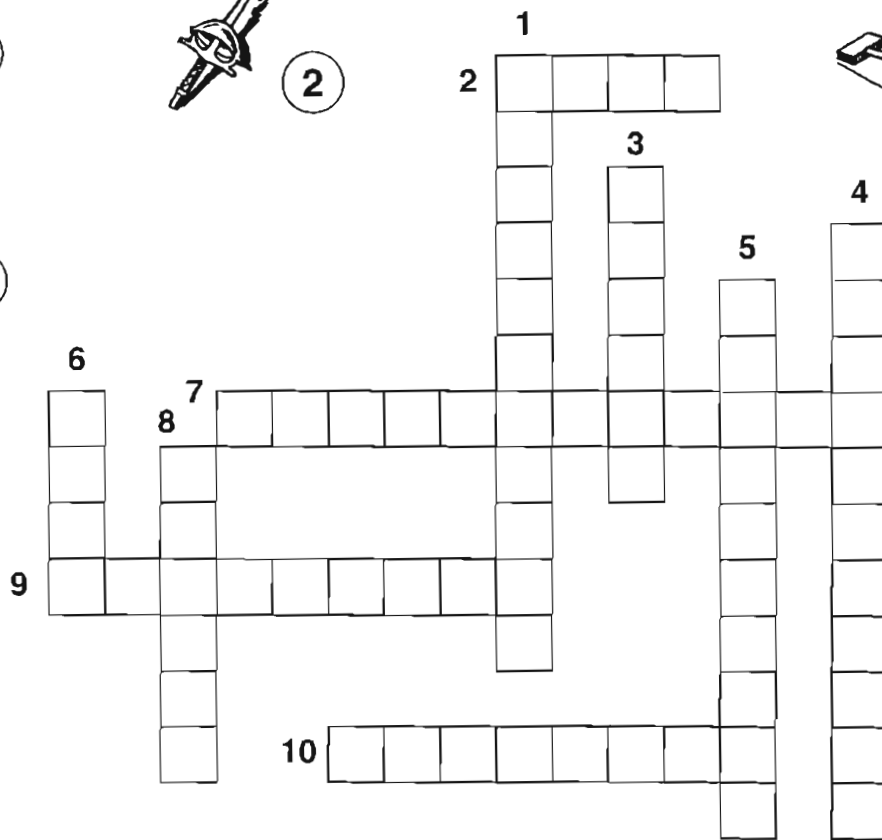

5

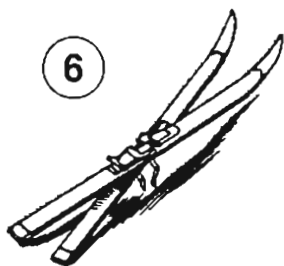

6

7



8

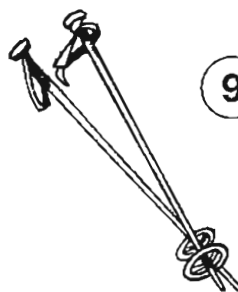

9

10

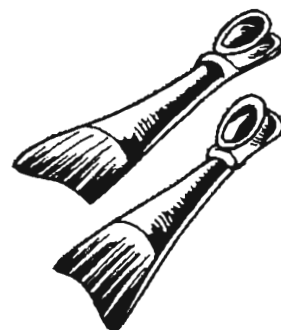

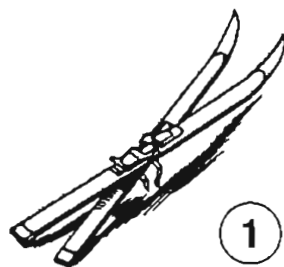

1



2

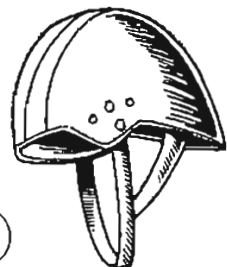

3

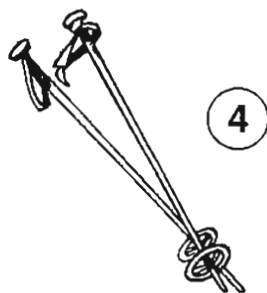

4

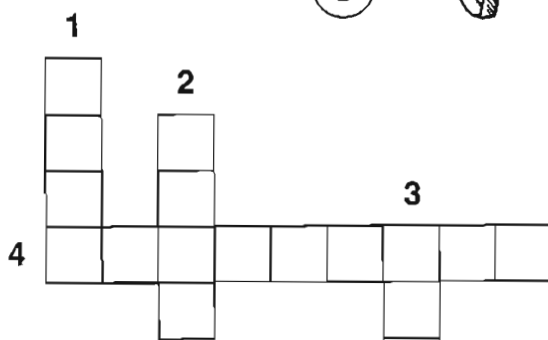

5

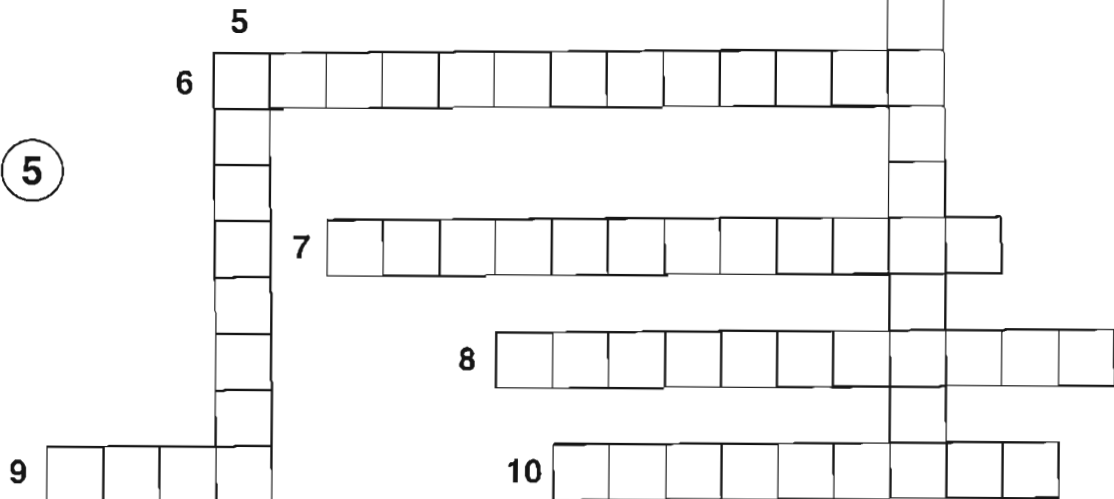

6

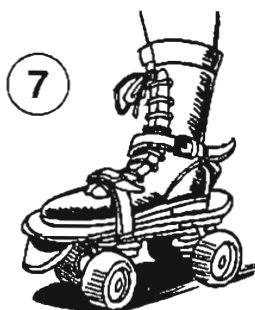

7

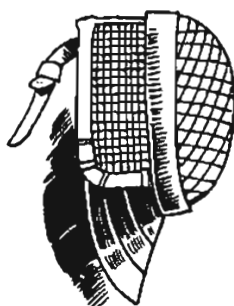

8

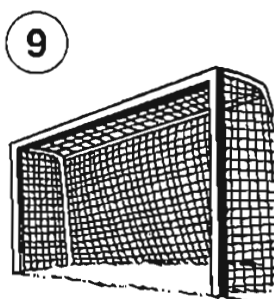

9

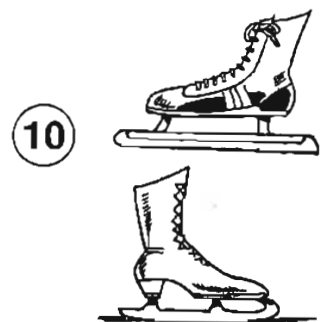

10

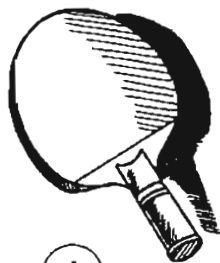

1

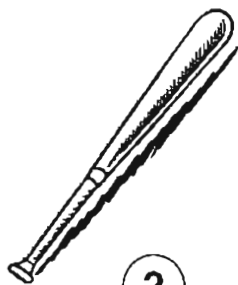

2



3

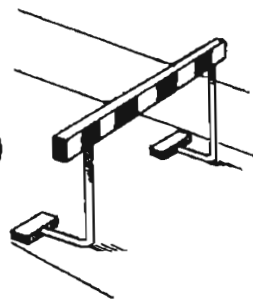

4

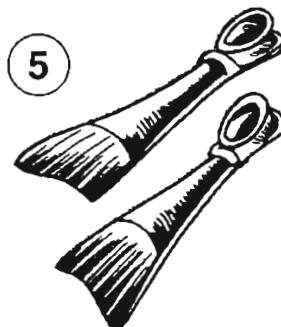

5

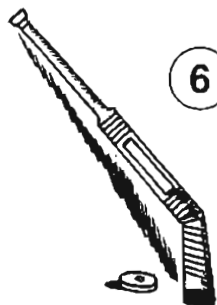
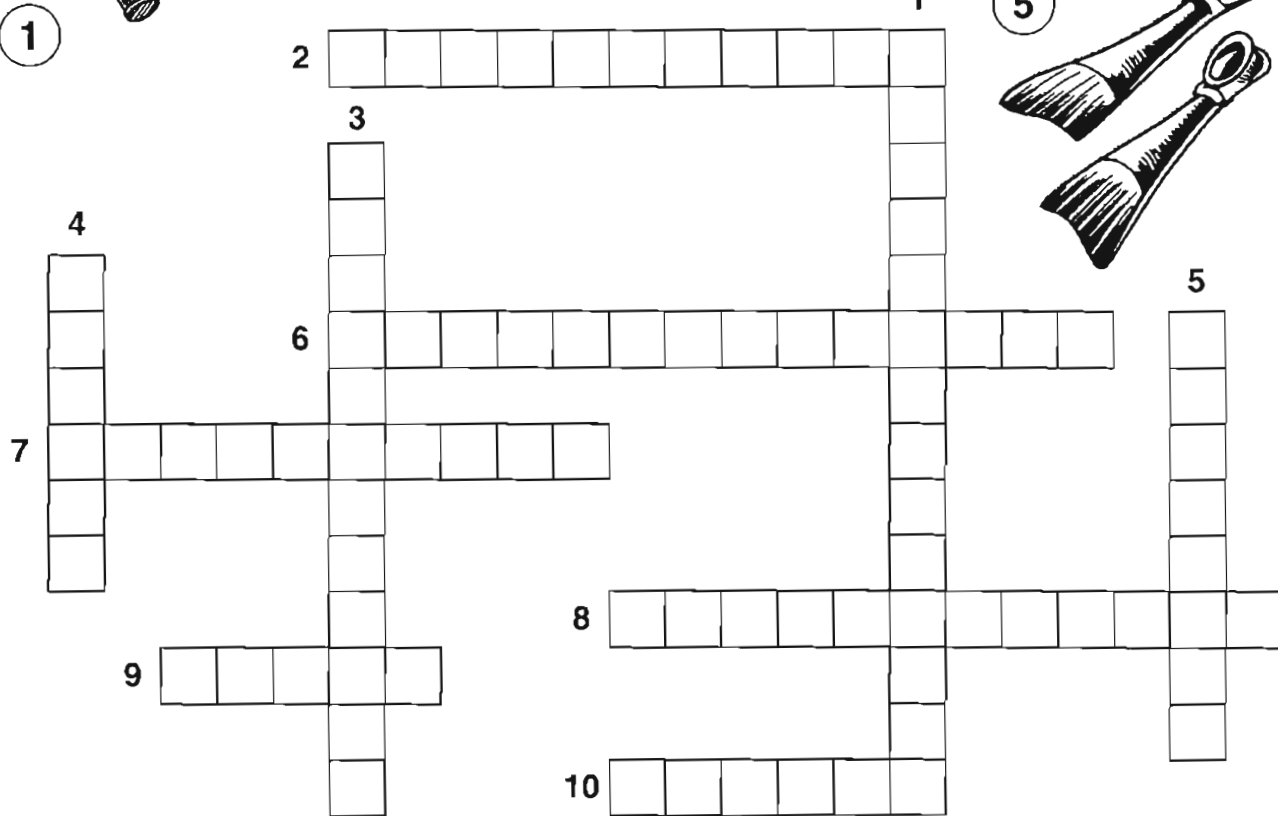

6



8

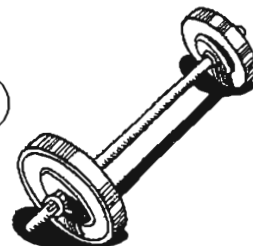

10

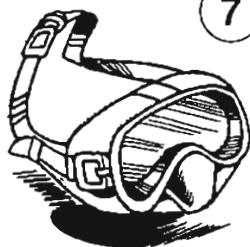

7



9

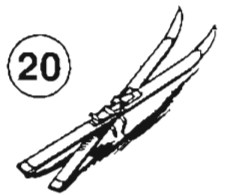
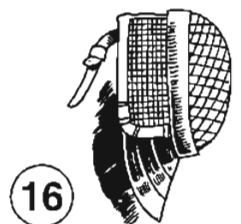
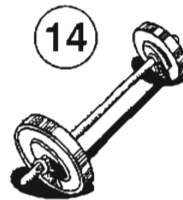
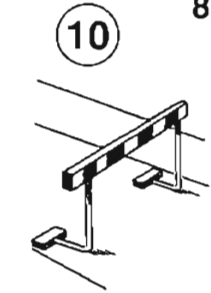
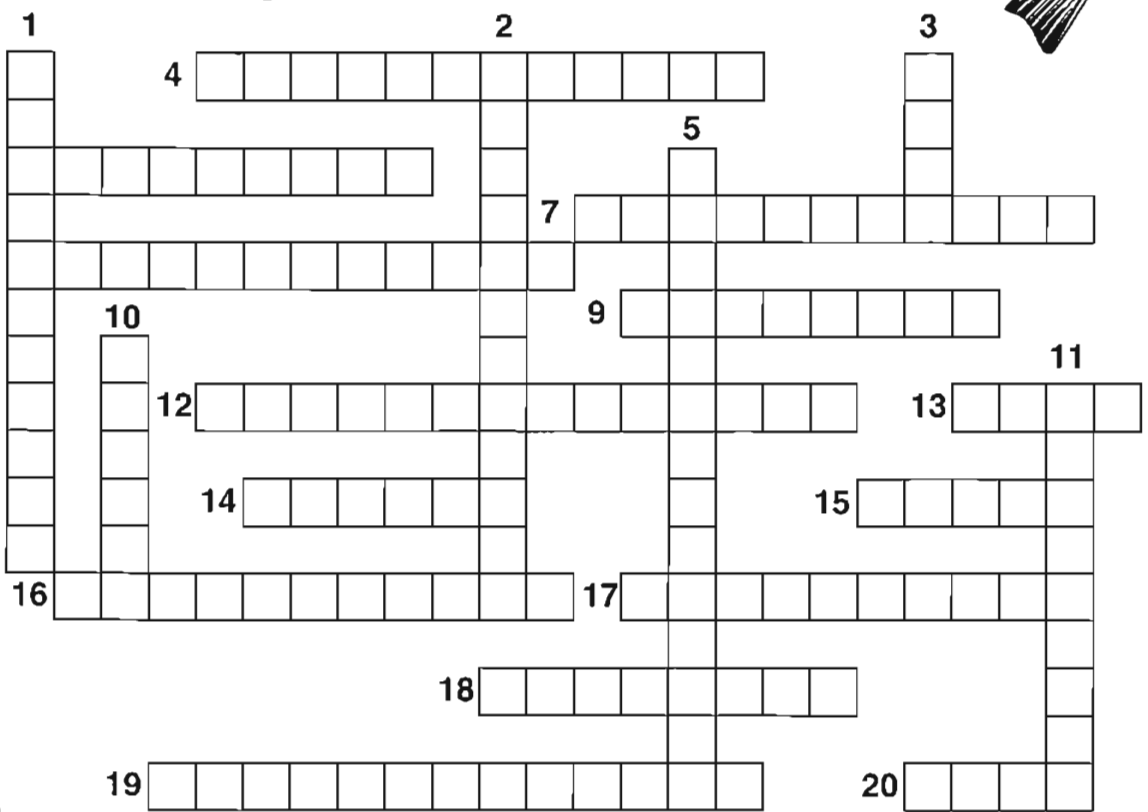
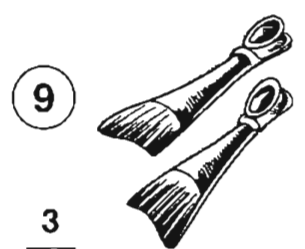
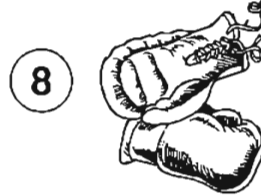
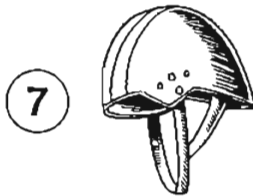
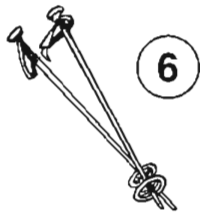
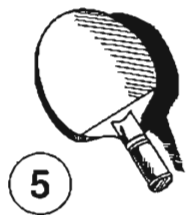
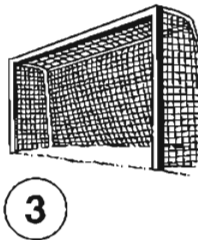
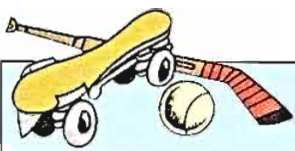



IN THE BATHROOM



soap



sponge



toothbrush



toothpaste



razor



shaving foam



hairbrush



comb



shampoo



hair drier

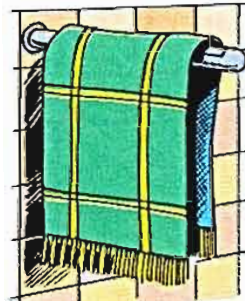

hand towel



bathrobe



shower cap



face cream



perfume



lipstick



nail varnish



nail file



scissors

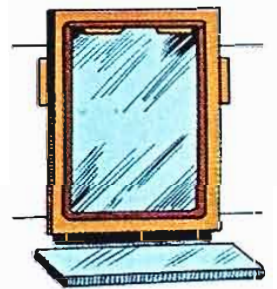

mirror



1

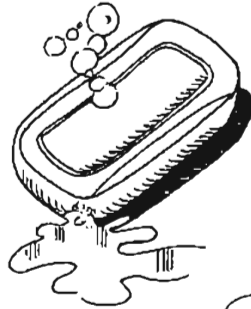

2

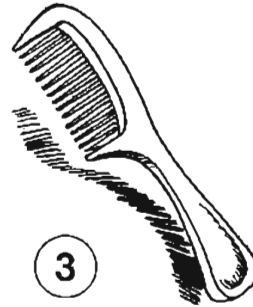

3

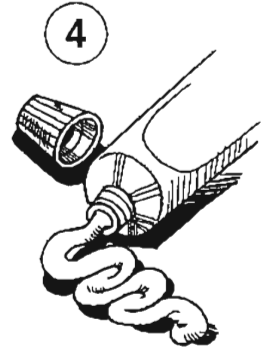

4

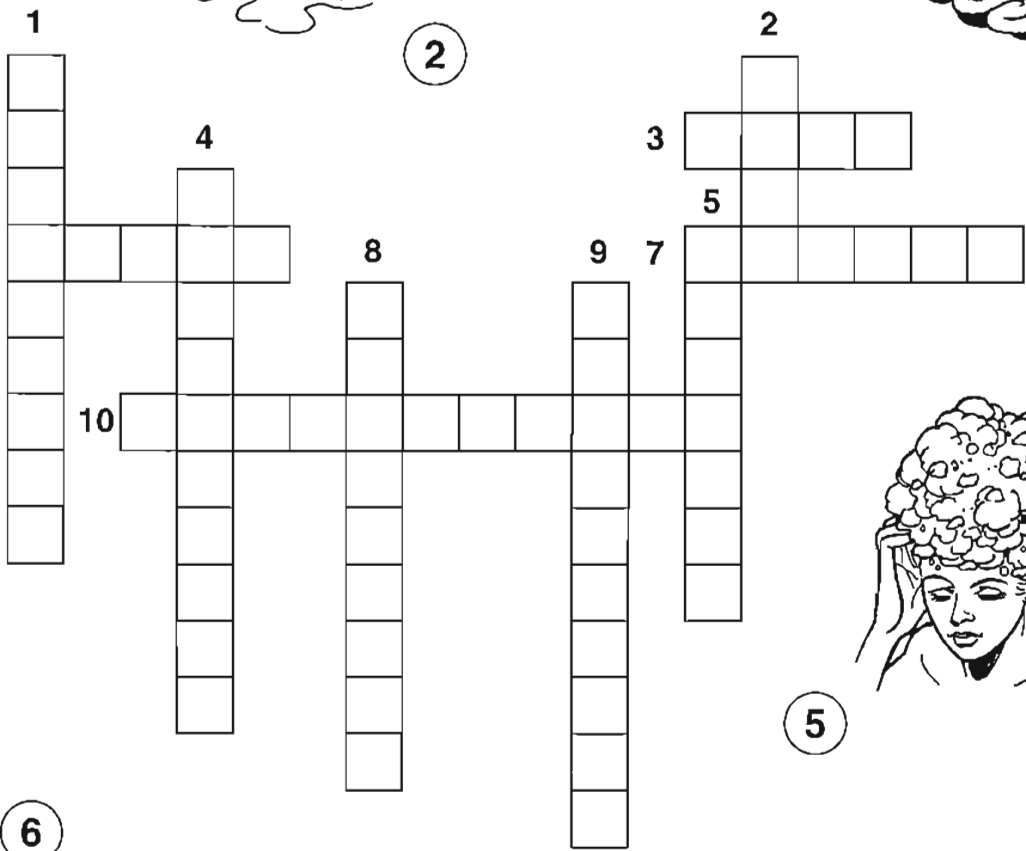

5



6



8



10

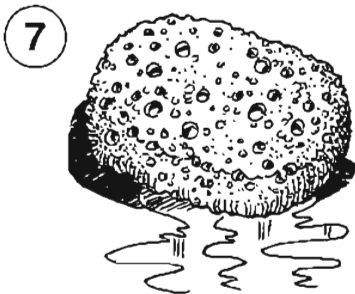

7

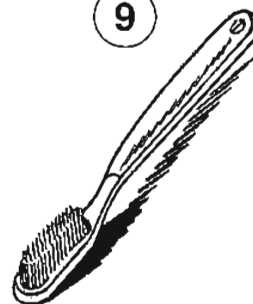

9

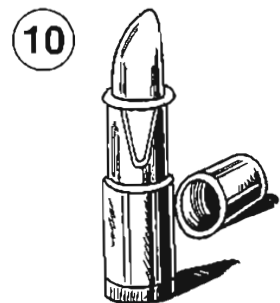
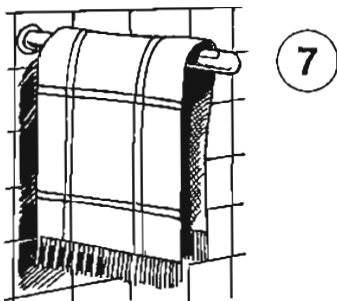
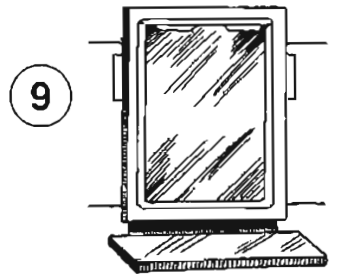
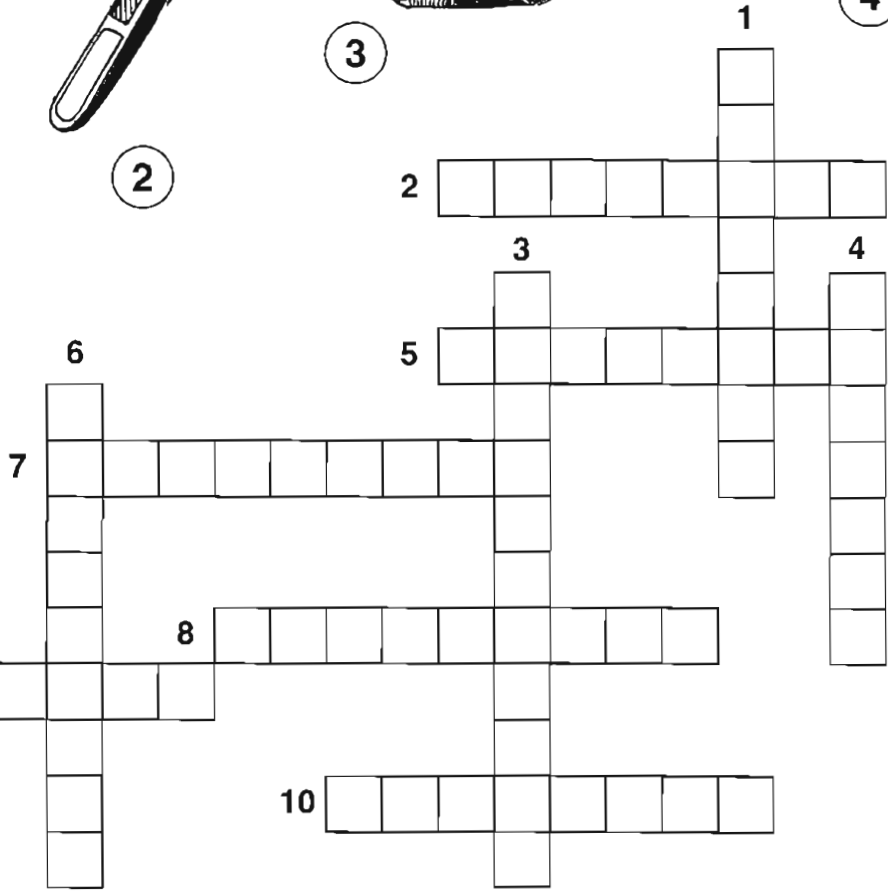
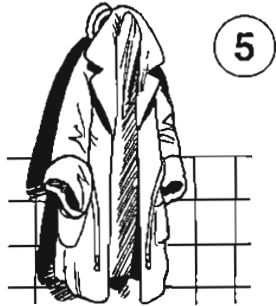
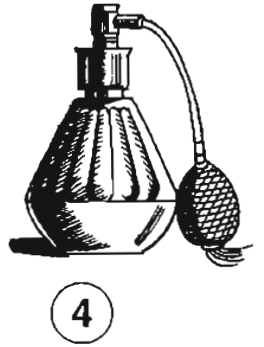
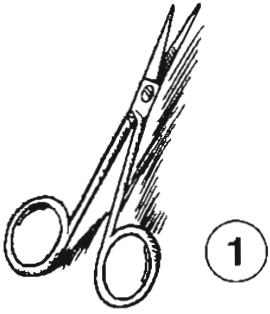



1

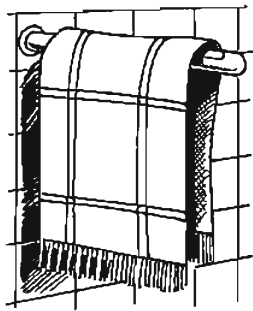

2



3



4



5

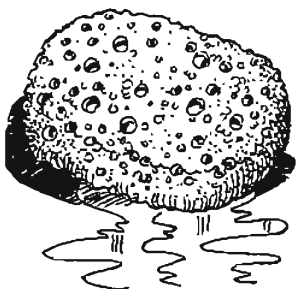
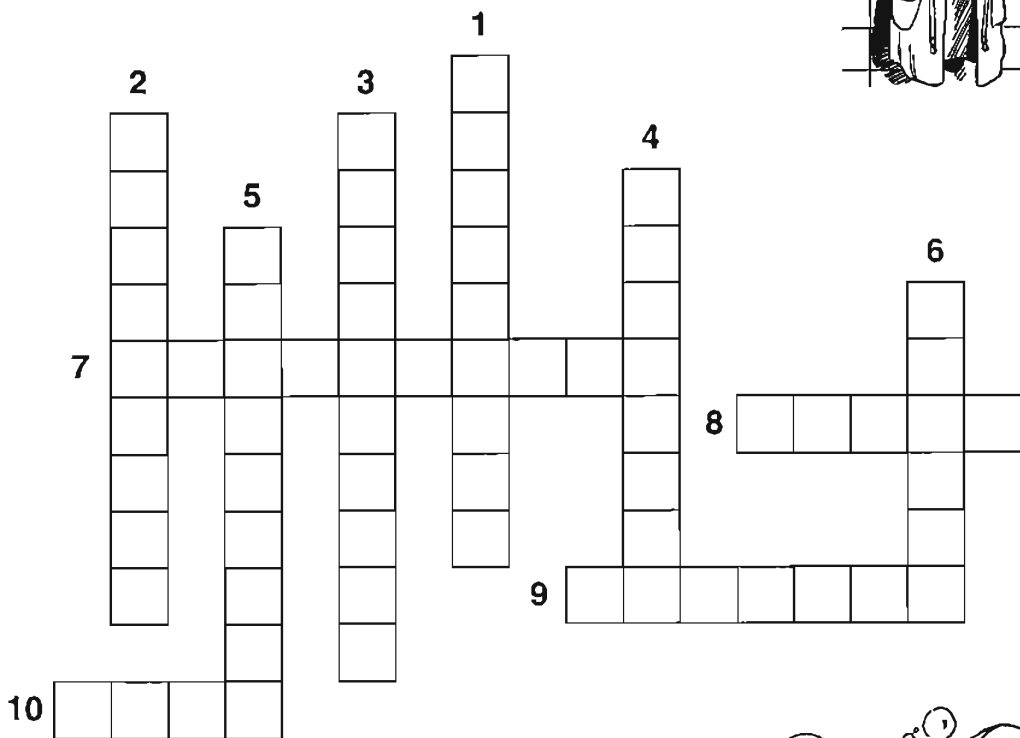

6

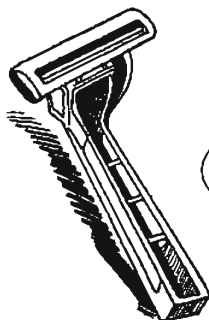

8

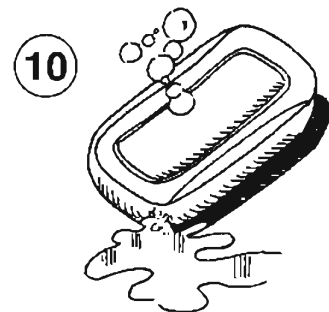

10

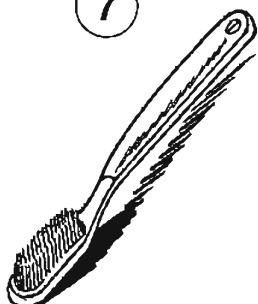

7



9



1



2



3



4

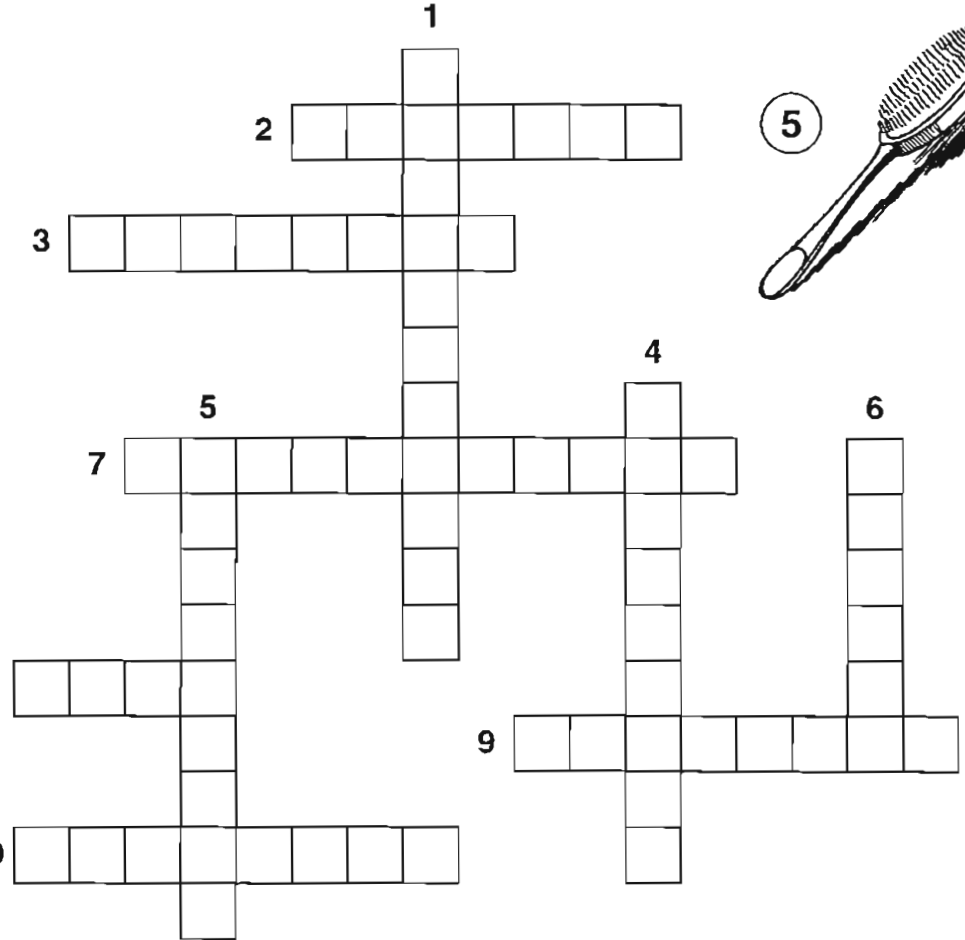

5

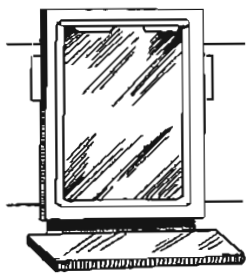

6

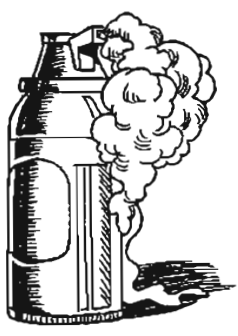

7



8

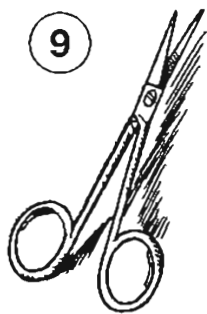

9

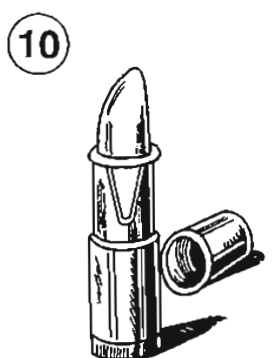

10

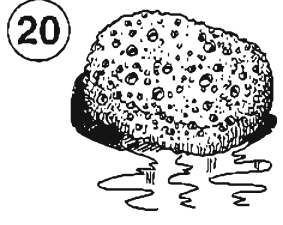
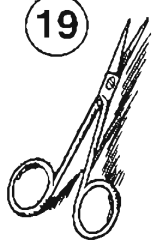
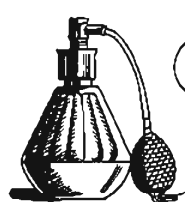
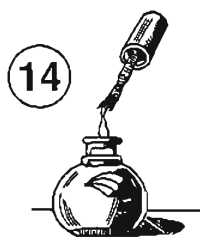
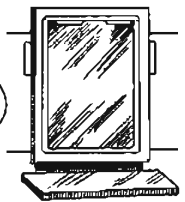
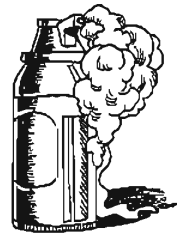
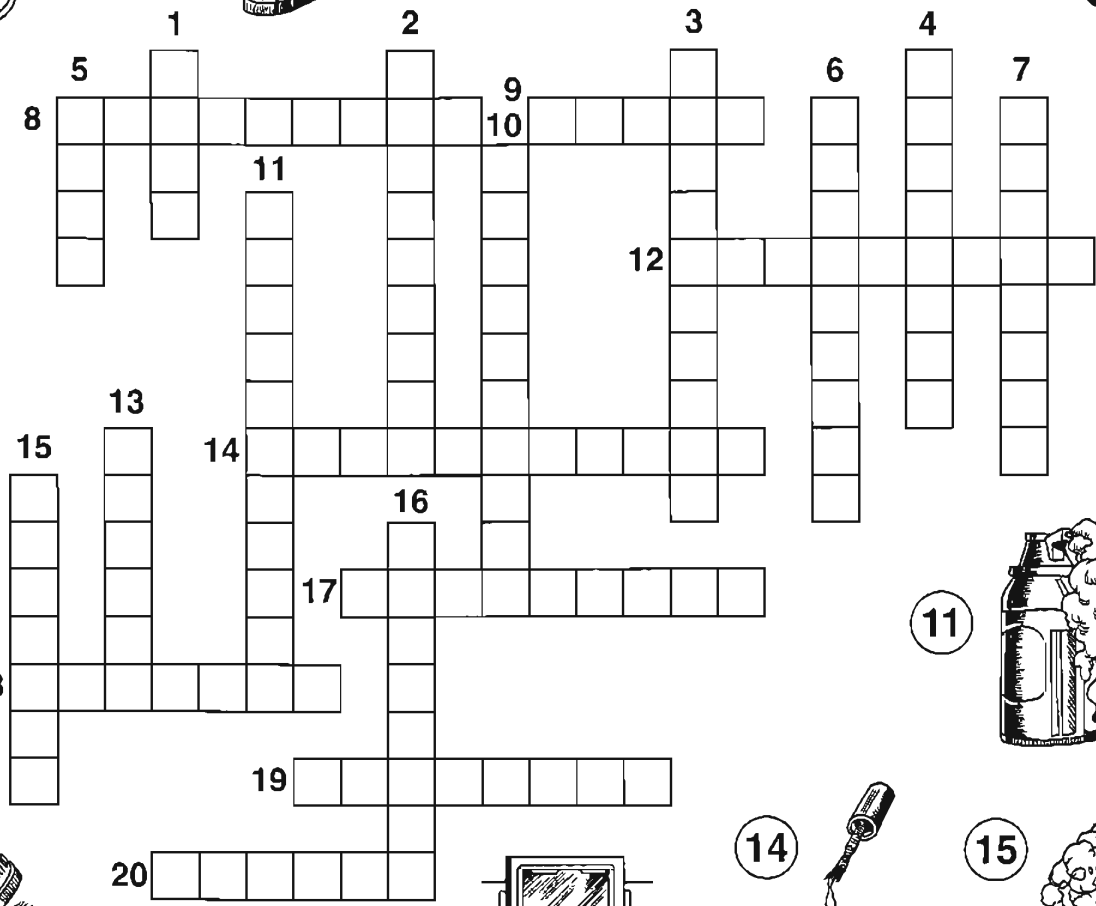
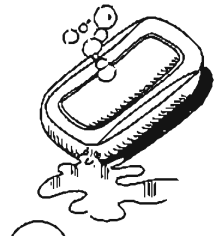
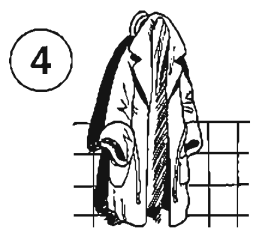
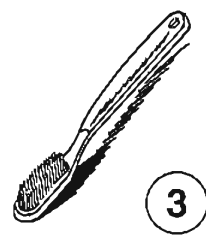
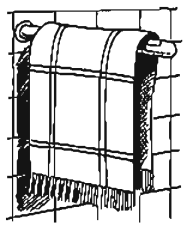



THE HOSPITAL



hospital

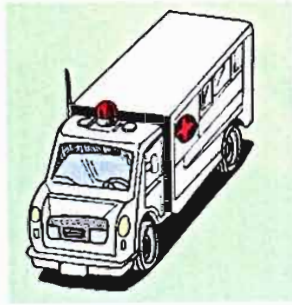

ambulance



doctor



surgeon



bed



nurse



thermometer



medicine



syringe

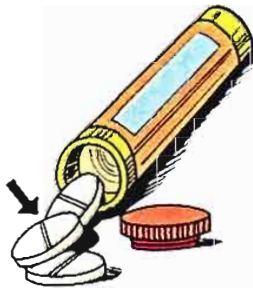

pills



cotton wool

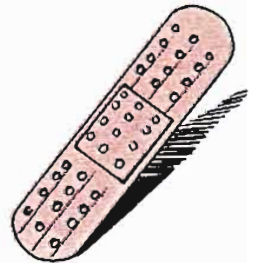

plaster



bandage



stretcher



stethoscope



surgical mask



patient



wound



black eye



bump



1



2



3



4

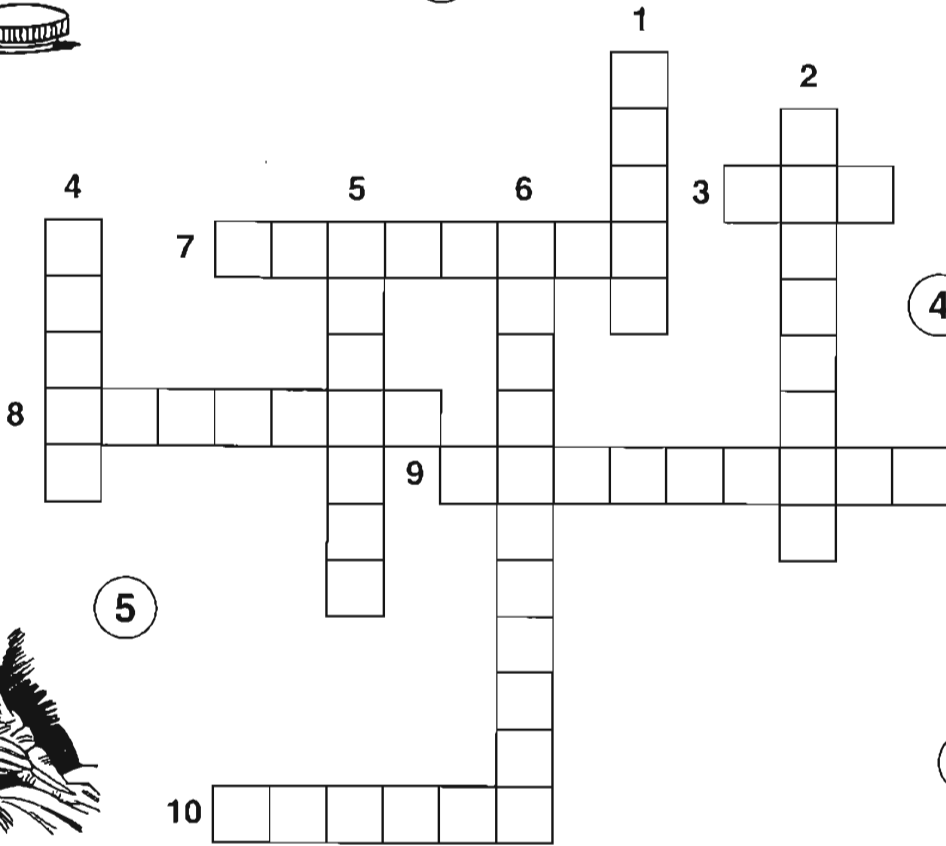

5



6



7

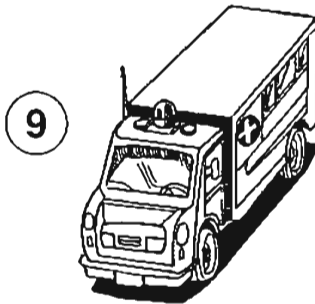

9

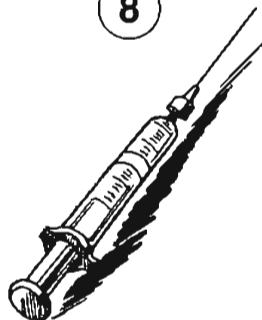

8



10

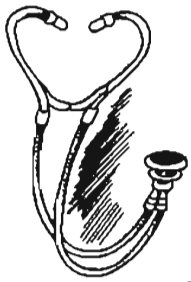

1

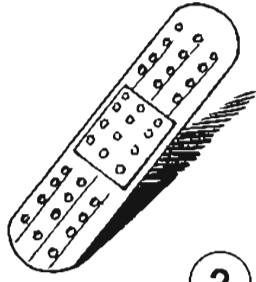

2



3

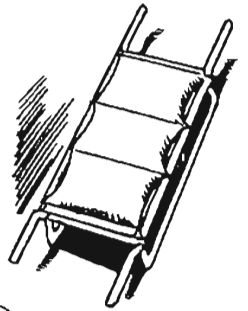

4

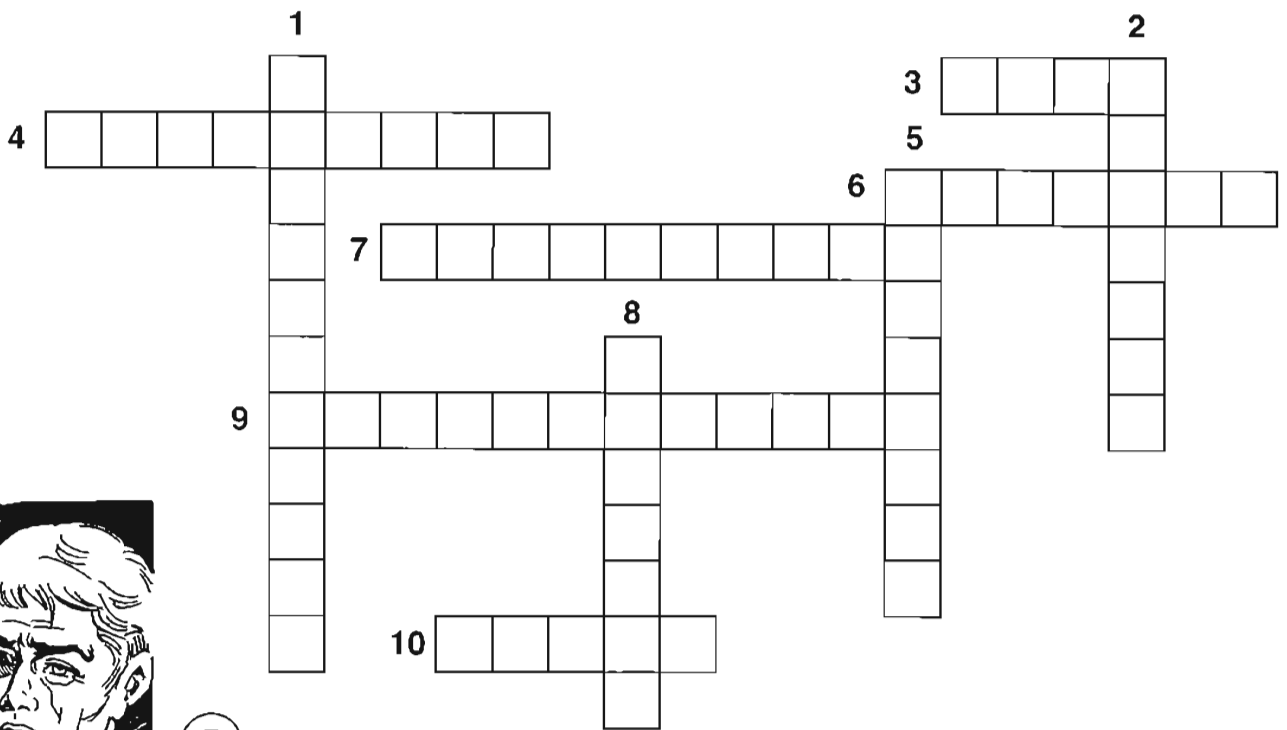

5

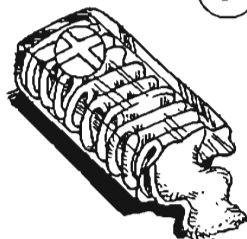

7



9

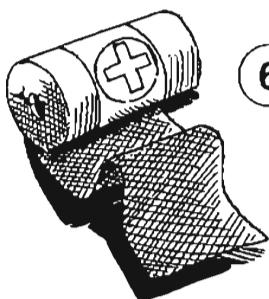

6



8



10



1



2



3

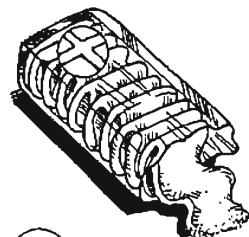

4

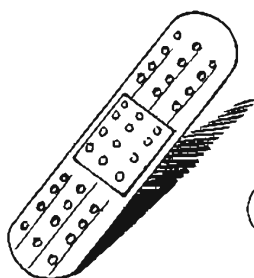

5

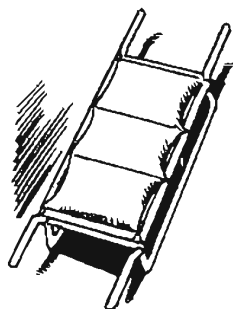

6

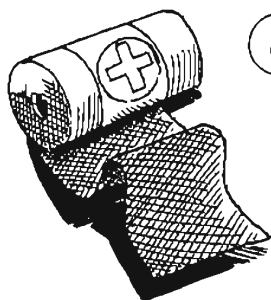

8

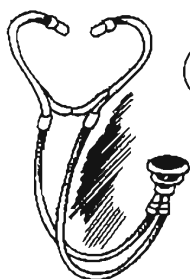

7

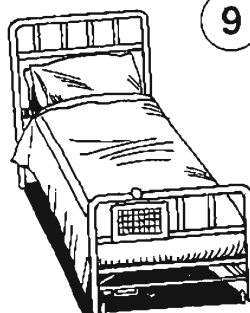

9

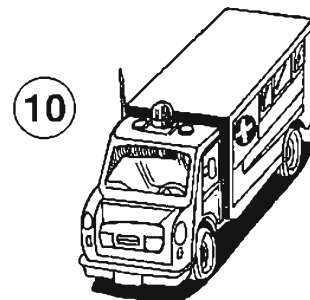

10

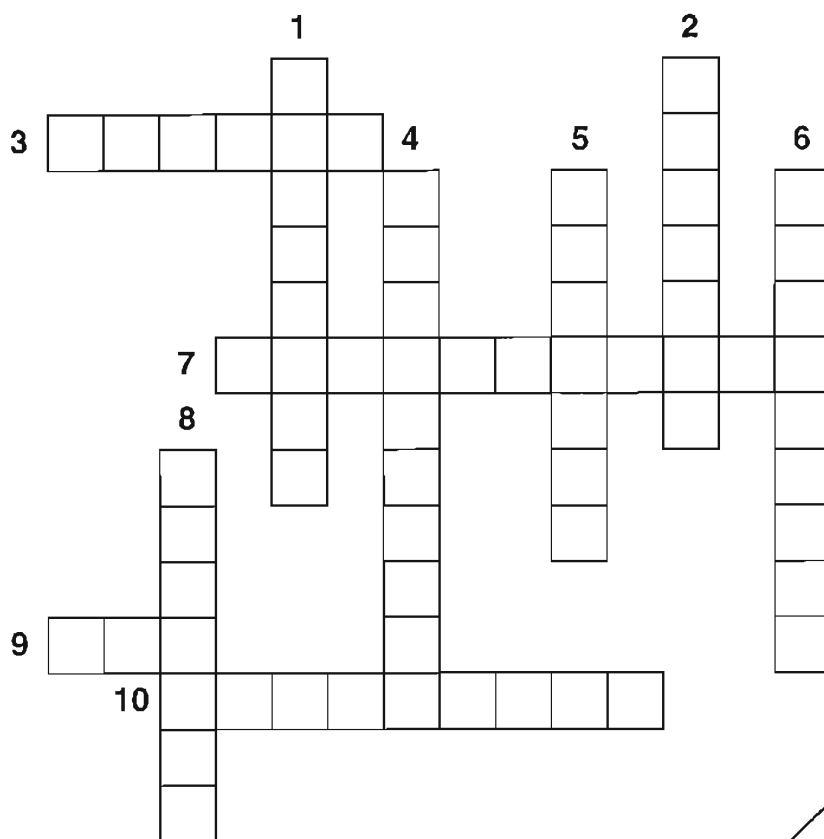



1

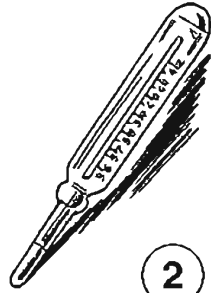

2



3



4



5

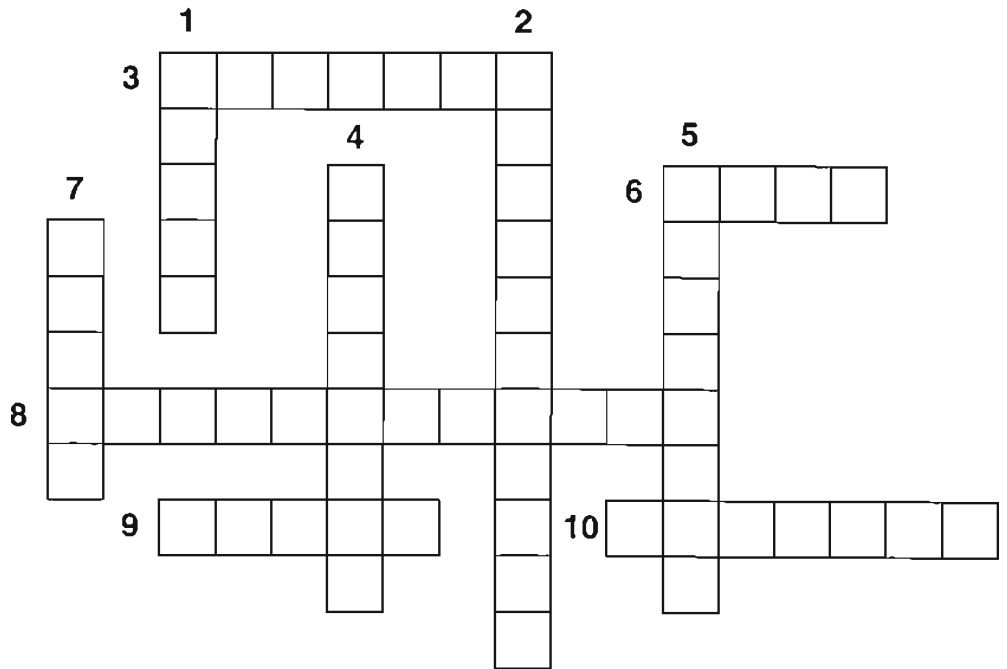

6



8

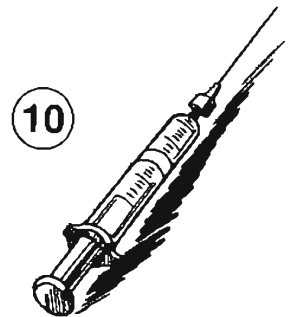

10



7



9



1



2

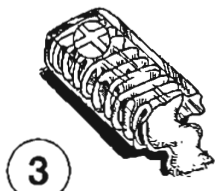

3



4

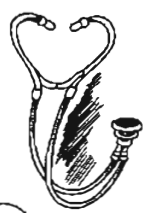

5



6



7



8



9

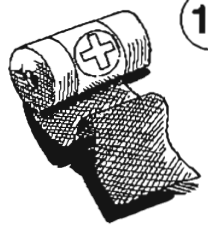

10

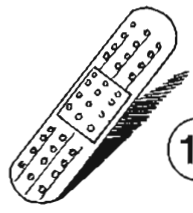
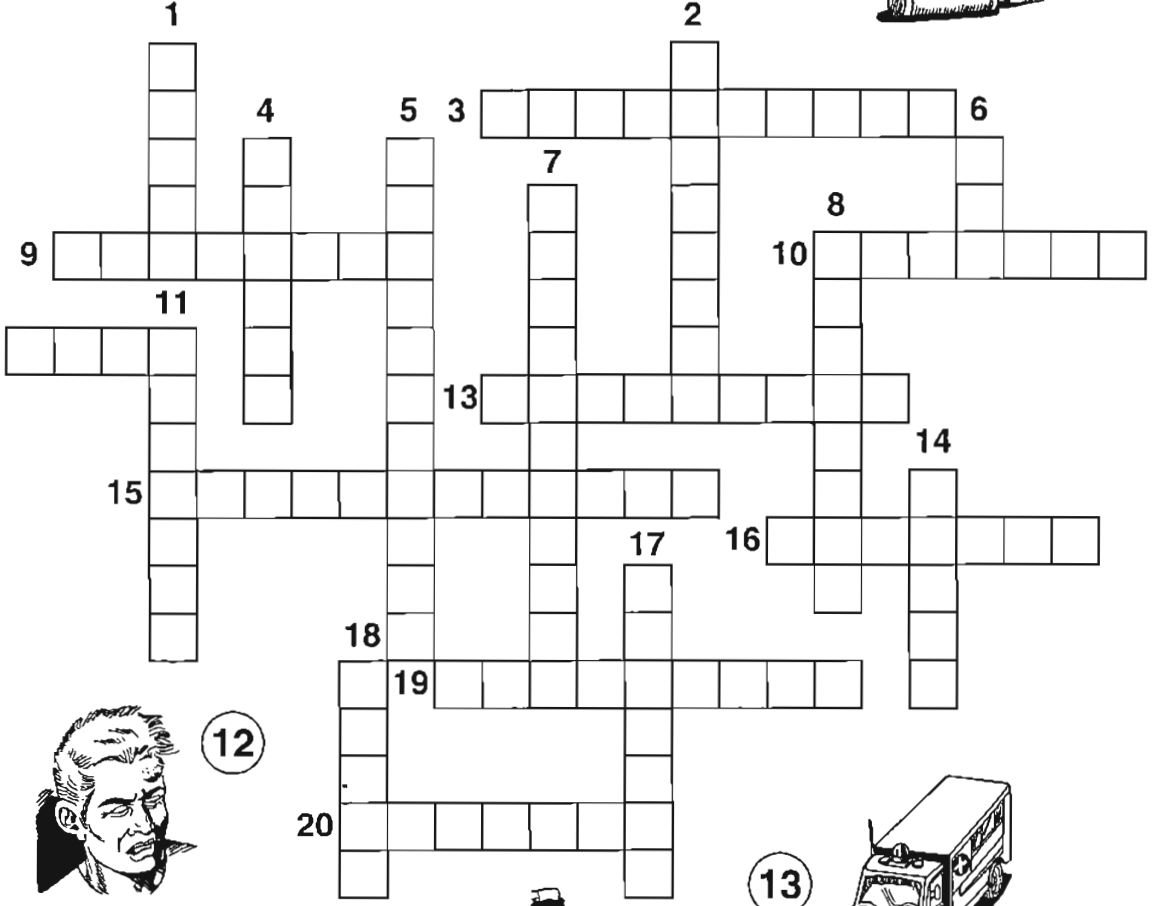

11



12



14



16



18



13



15



17

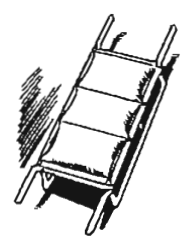

19



20

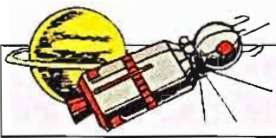

OUTER SPACE

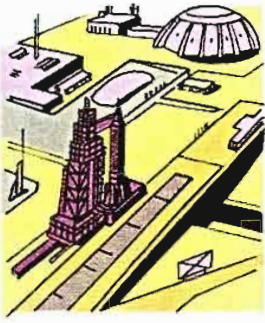

launch pad

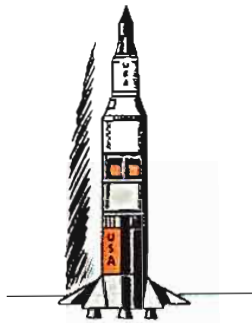

rocket



module



shuttle

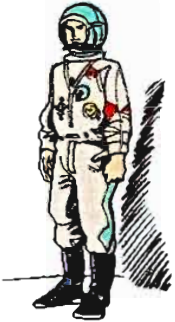

astronaut



space suit



lunar buggy



orbit

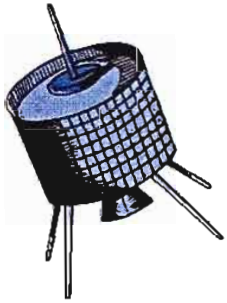

satellite

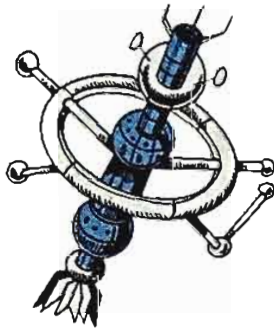

space station

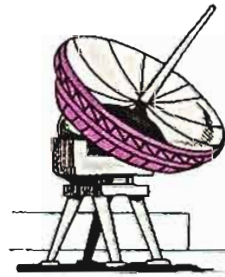

radio telescope

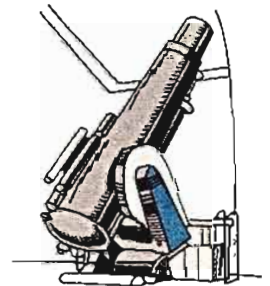

optical telescope



earth

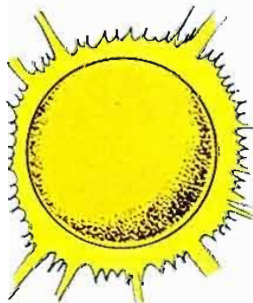

sun



stars



planet



moon



comet



meteor



galaxy



1

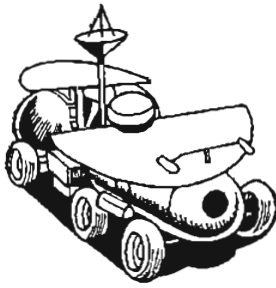

2

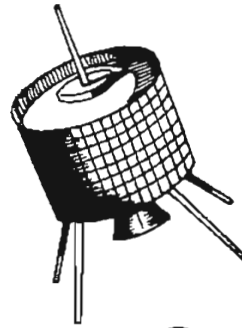

3



4

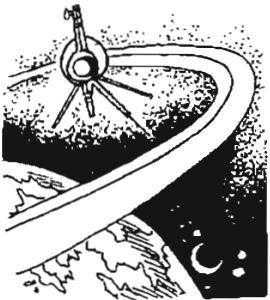

5

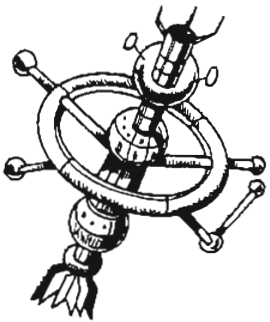

6

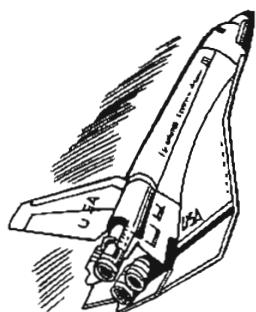

7

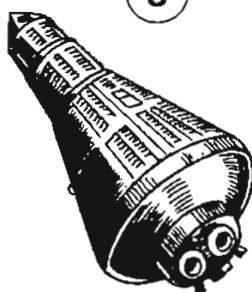

8



9

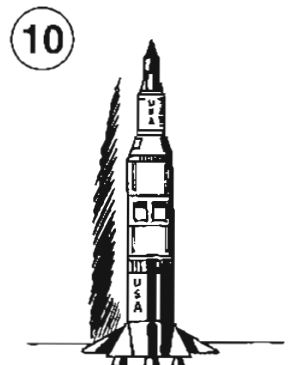

10

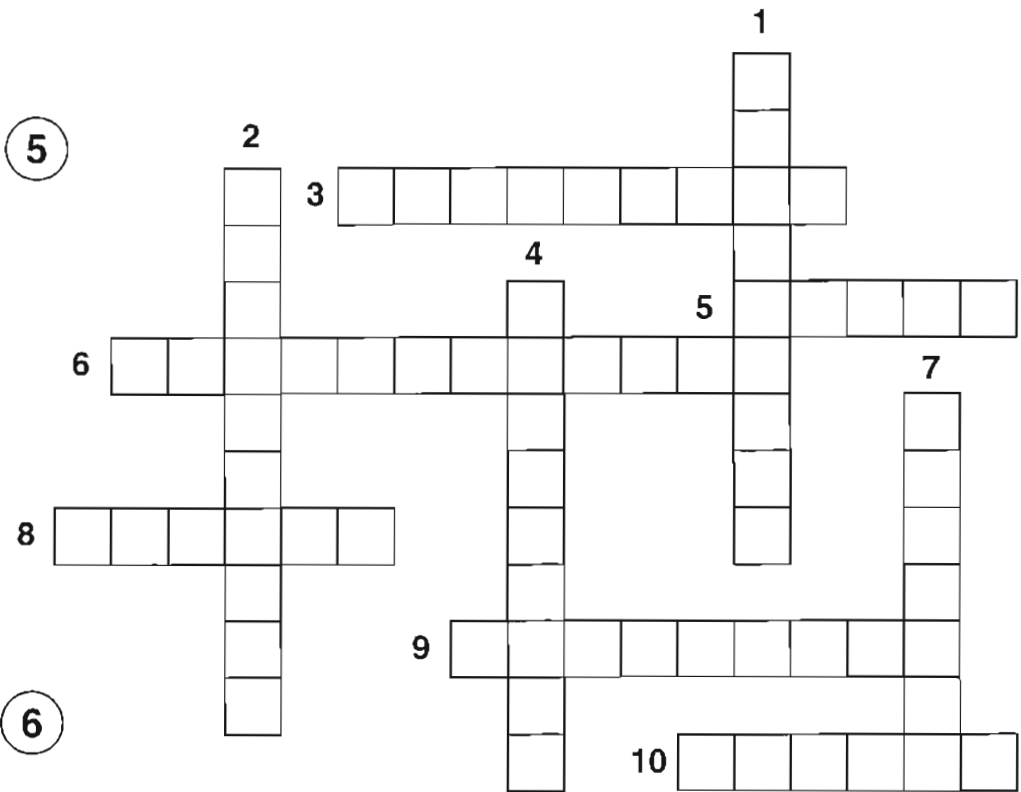

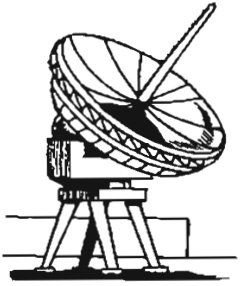

1



2



3



4



5

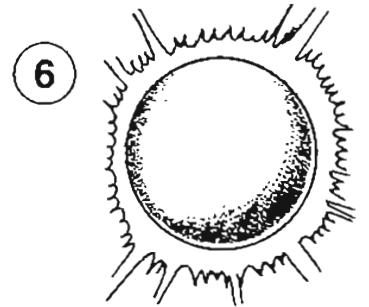

6

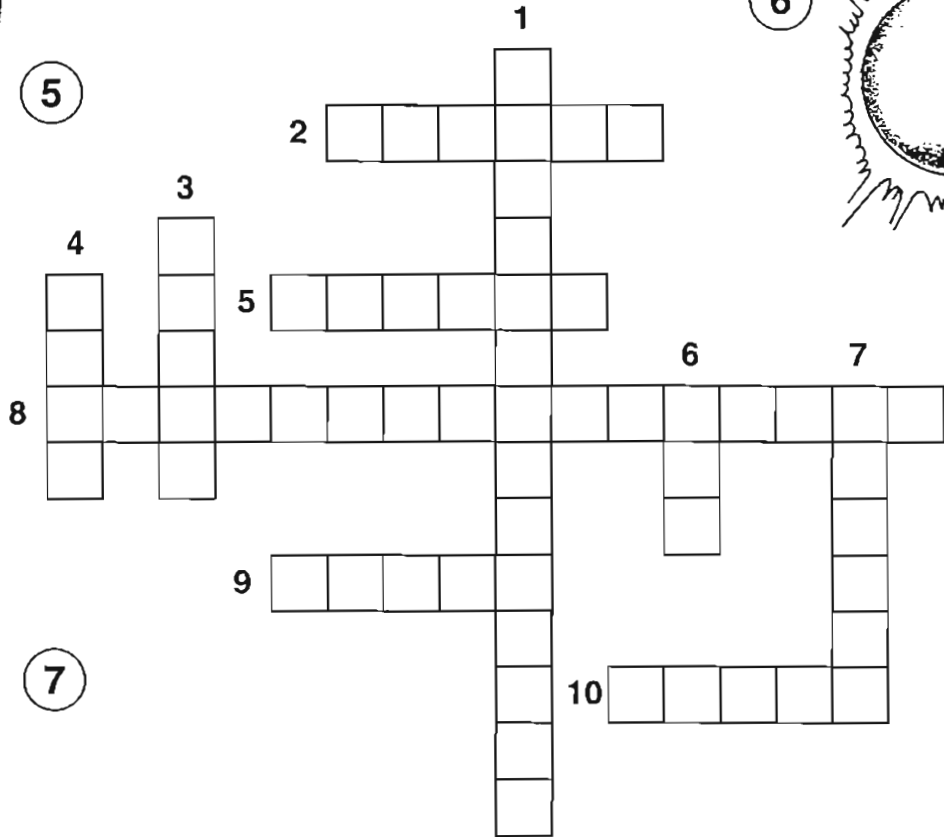

7

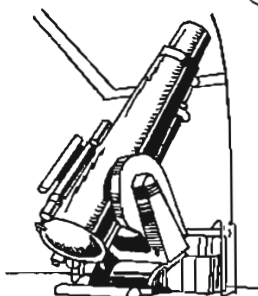

8



9



10



1



2

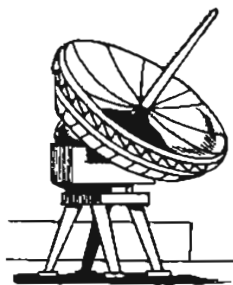

3

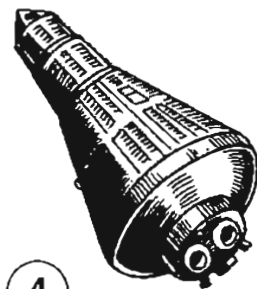

4



5

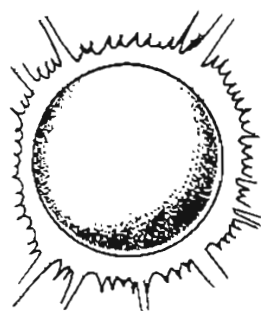
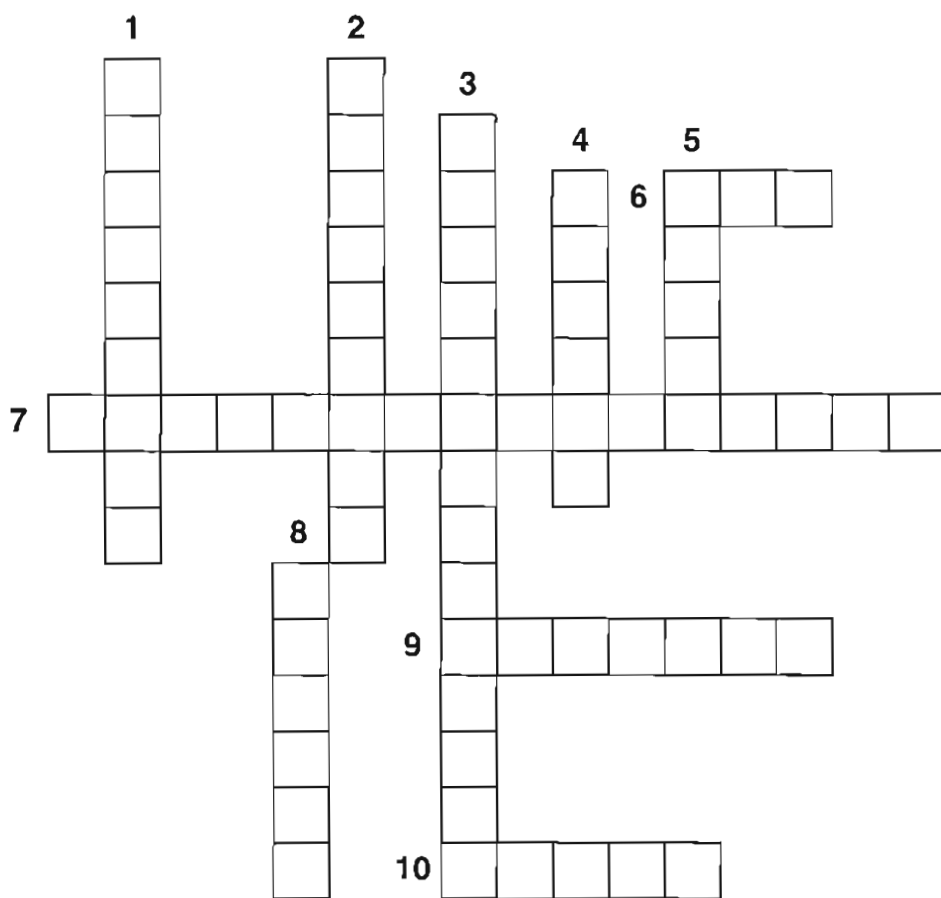

6

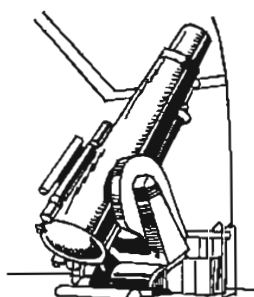

7

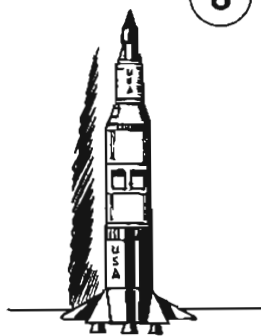

8

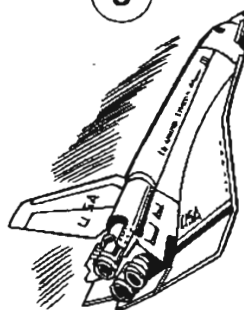

9



10



1



2



3



4

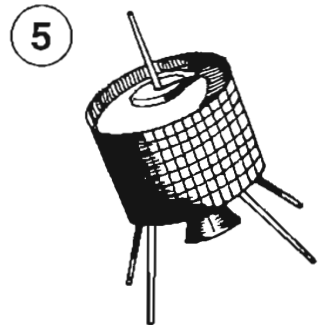
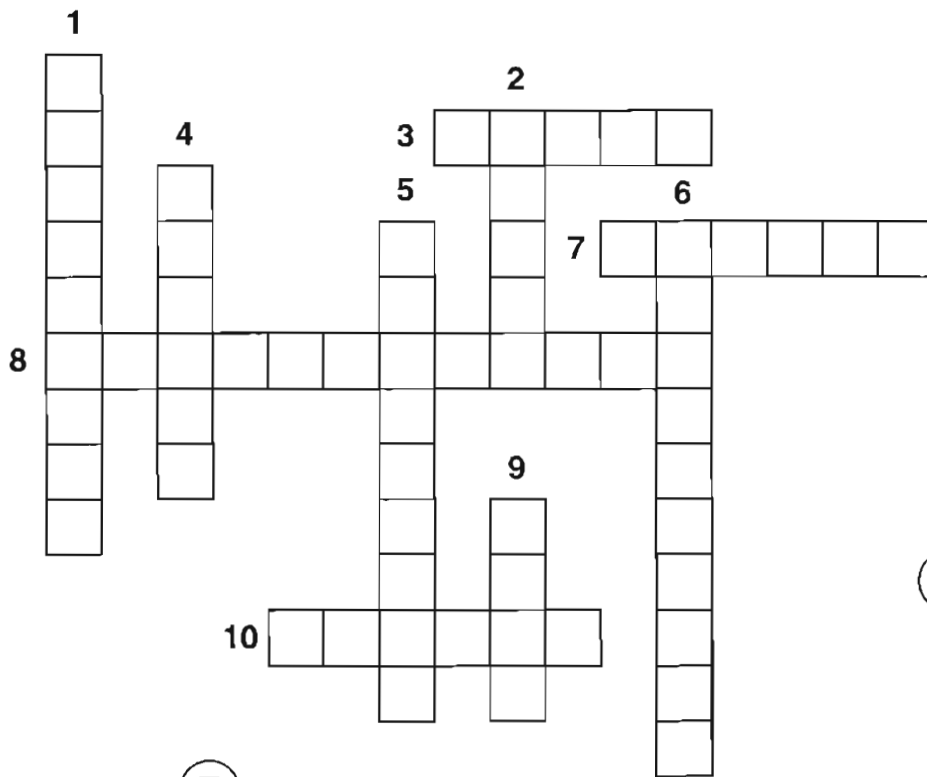

5

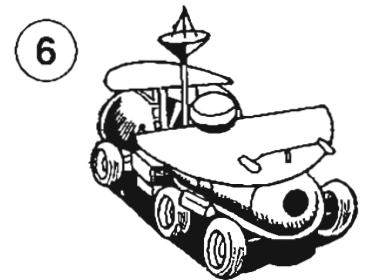

6



7



9

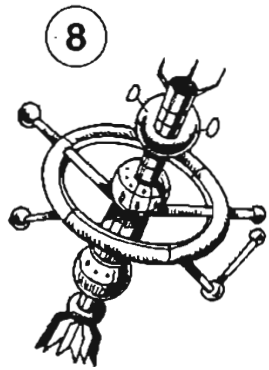

8



10



1



2

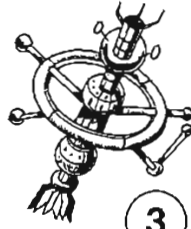

3

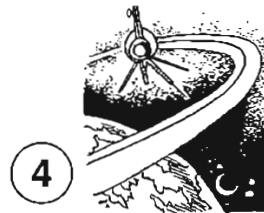

4



5



6



7



8



9



10

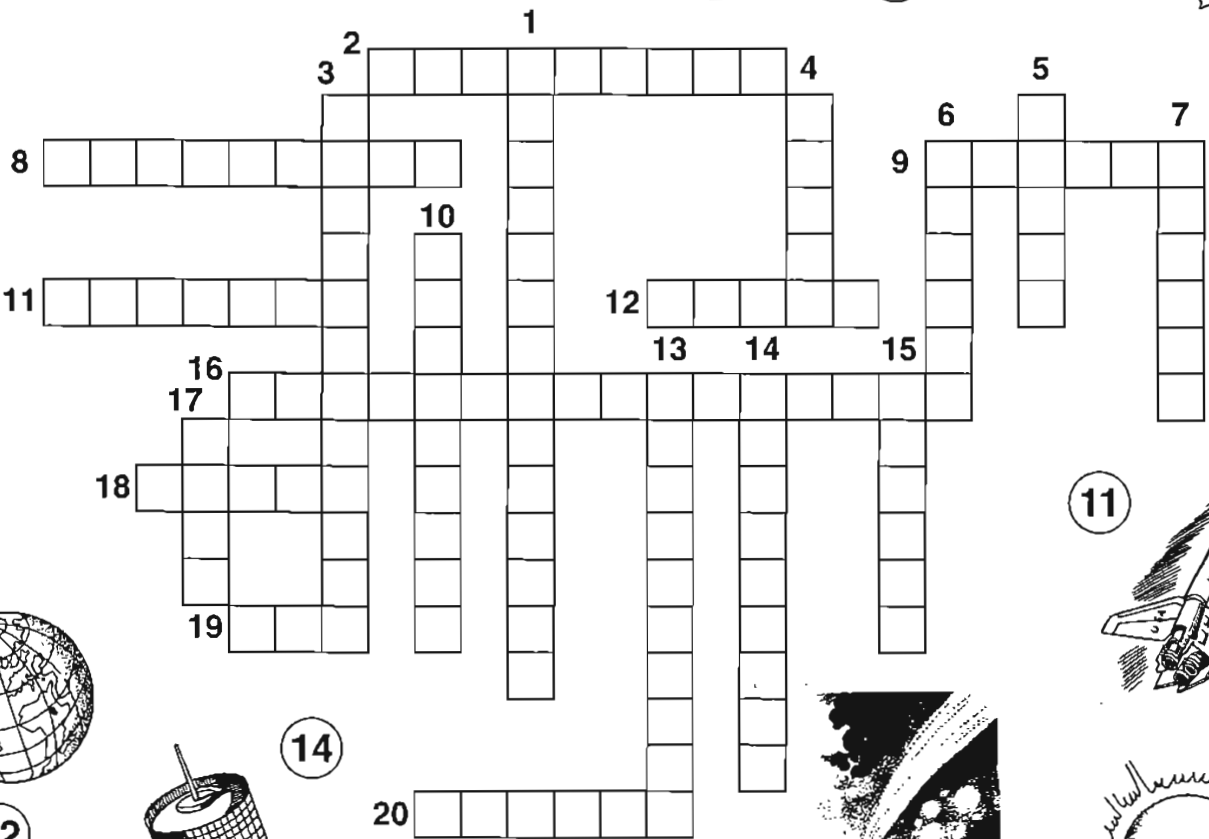

12

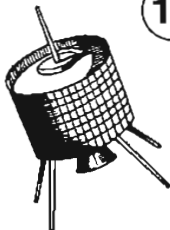

14

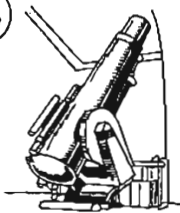

16



18



19

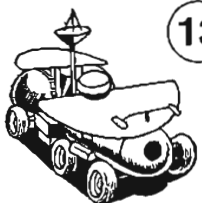

13



15



17



20

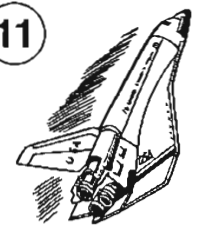

11



VERBS



cut



kneel



measure



play



clap



act



ride



fly



dive



swim



catch



buy



sit down



stand up



prune



plant



break



wash



dress



comb



1

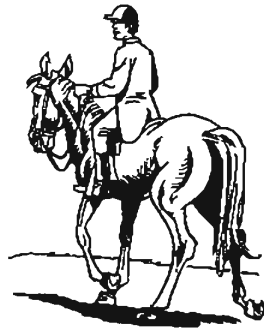

2



3



4

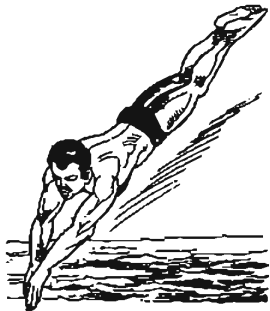
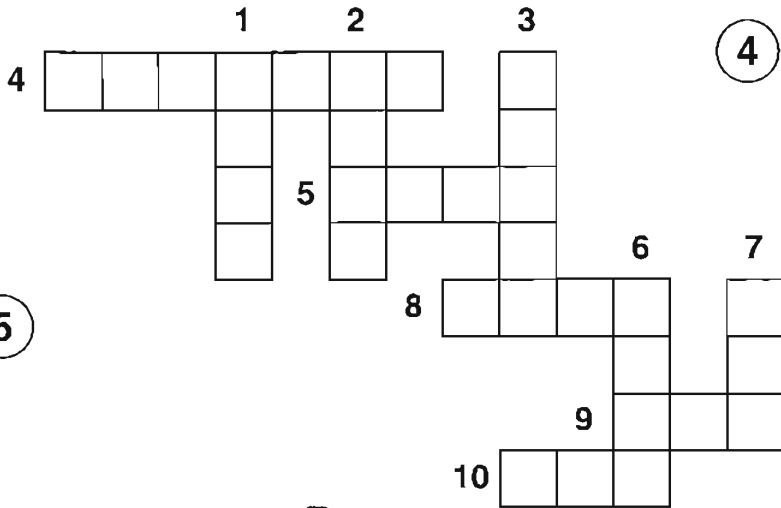

5



7



9



6



8

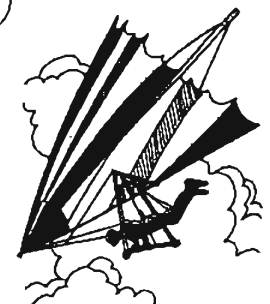

10

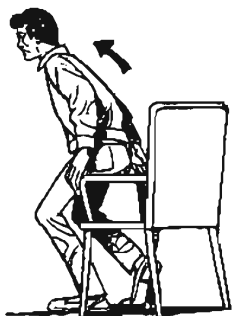
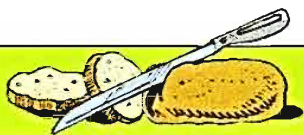

1

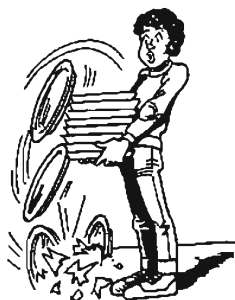

2



3



4



5

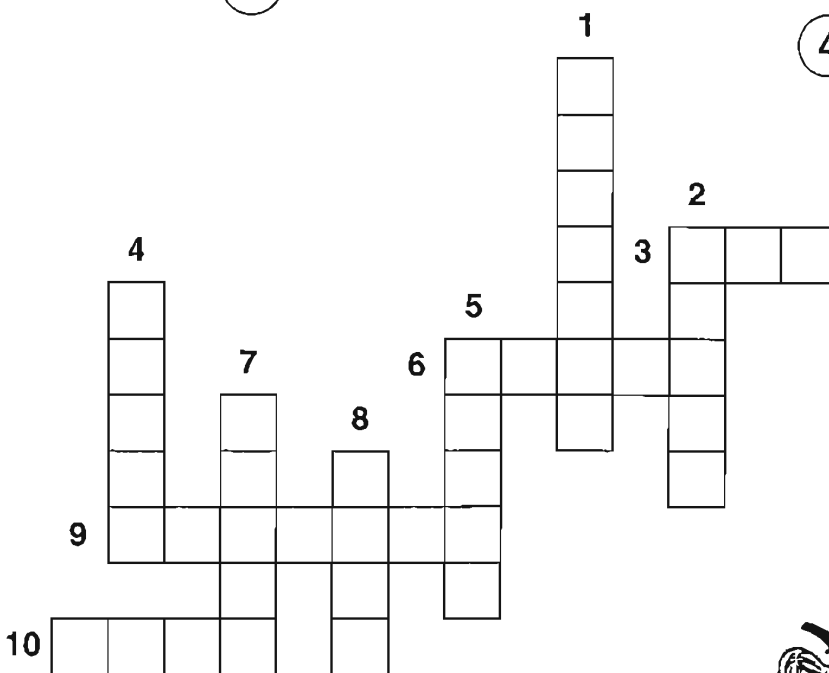

6



9



8



7

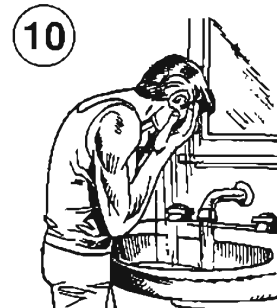

10



1



2



3



4

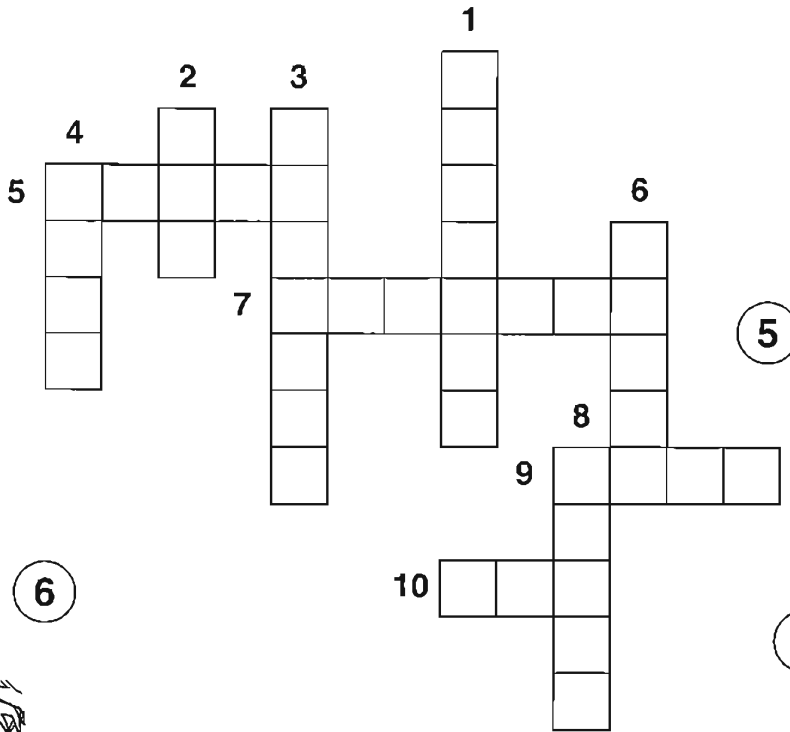

5



6

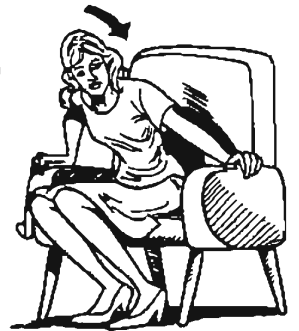

7



8



9



10



1



2



3

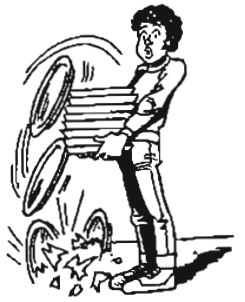

4



5



6

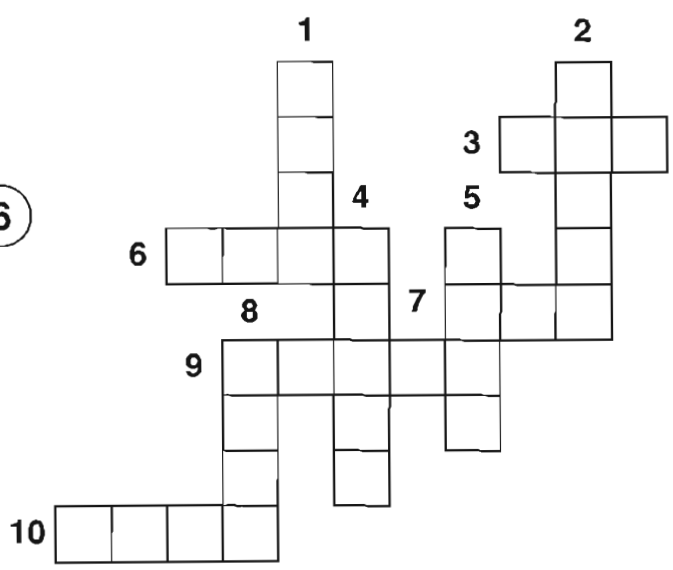

7



9

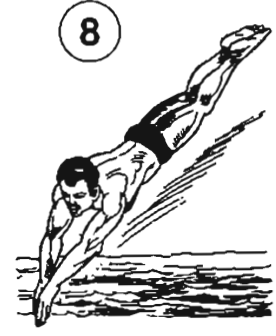

8

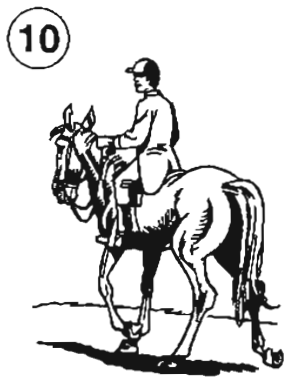

10



1

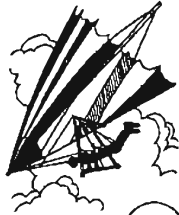

2



3



4



5



6



7



8

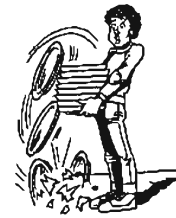

9

10



11

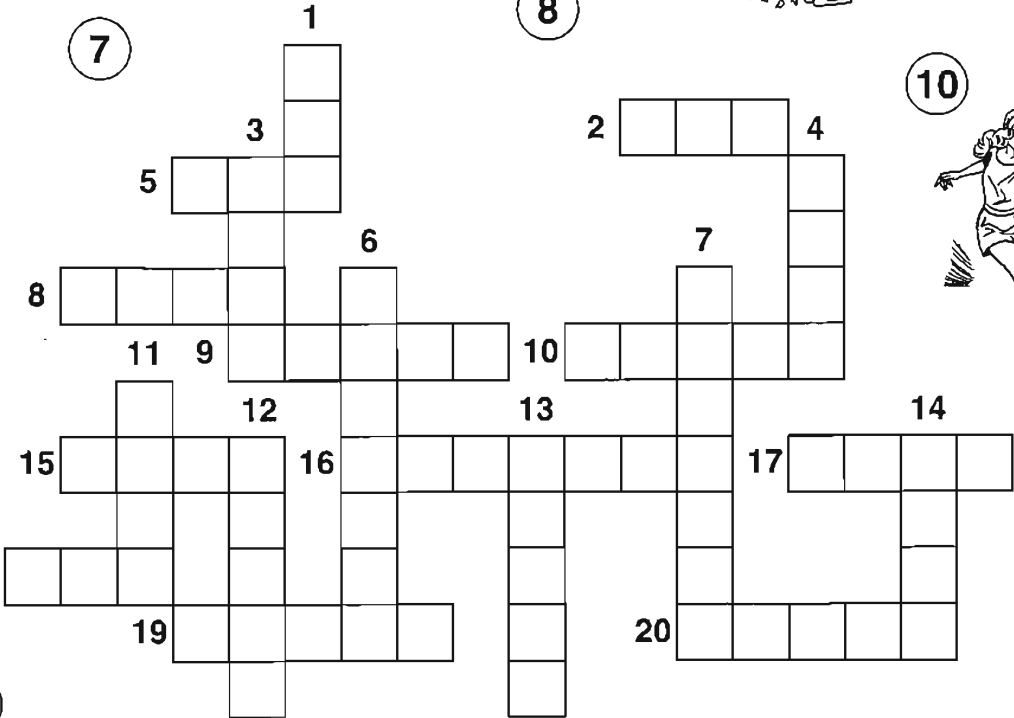

12



13

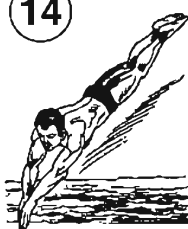

14



15



16



17



18



19



20



ADJECTIVES



clean



dirty



tidy



untidy



calm



rough



in tune



out of tune



light



heavy

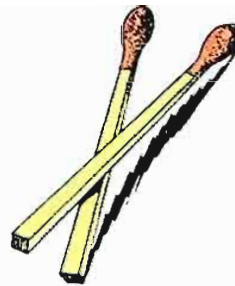

even



odd



dry



wet



quiet



noisy



soft



hard



left



right



1



2



3



4

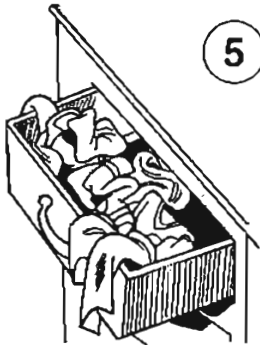

5

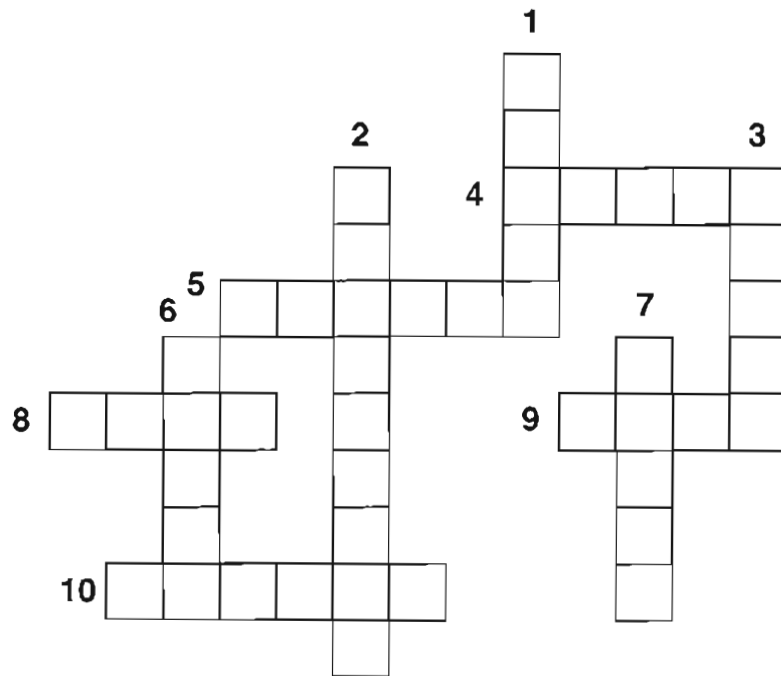

7

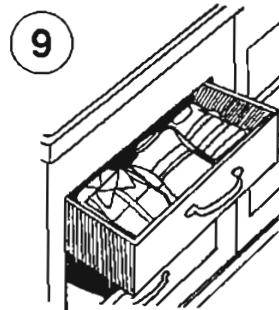

9



6

8



10



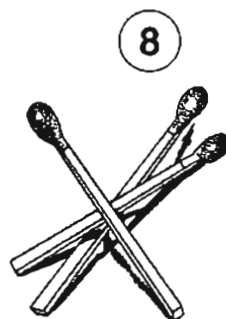
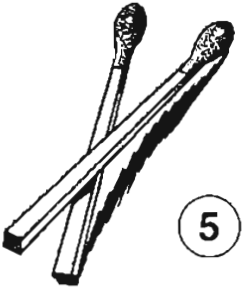
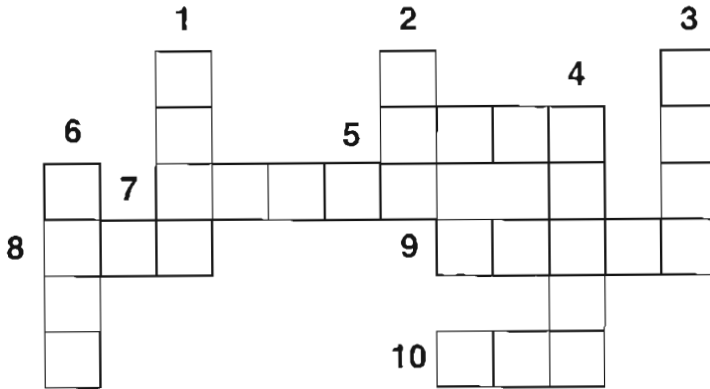
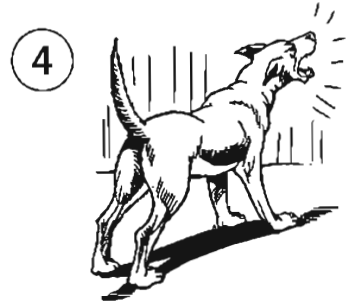



1

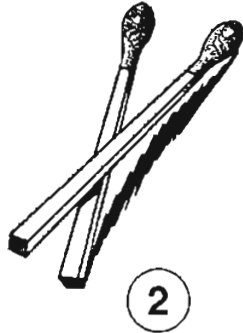

2

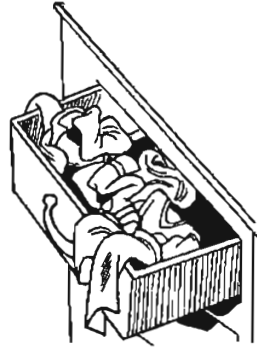

3

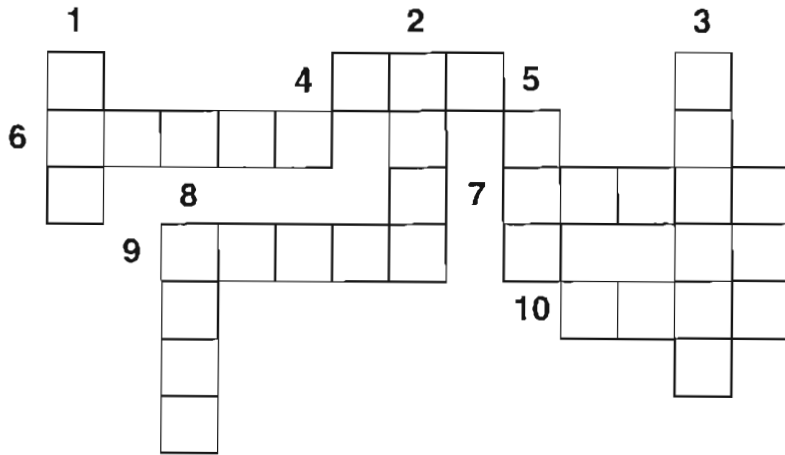

4



5

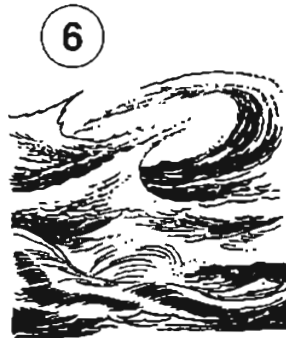

6



7



8



9

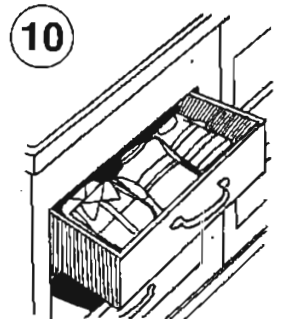

10



2



3



1



4

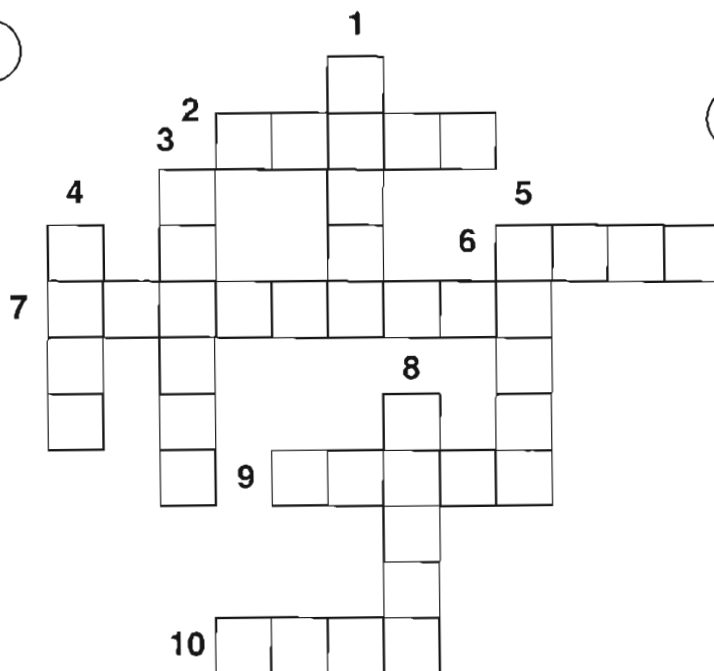

5



6



7

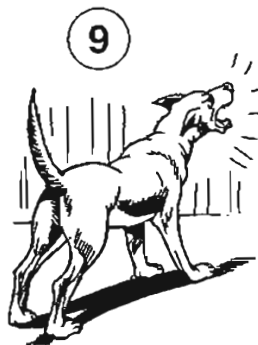

9



8



10



1



2

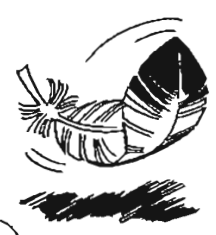

3



4



5

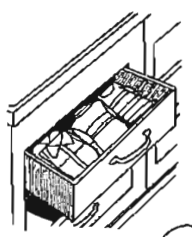

6



7



8



9



10

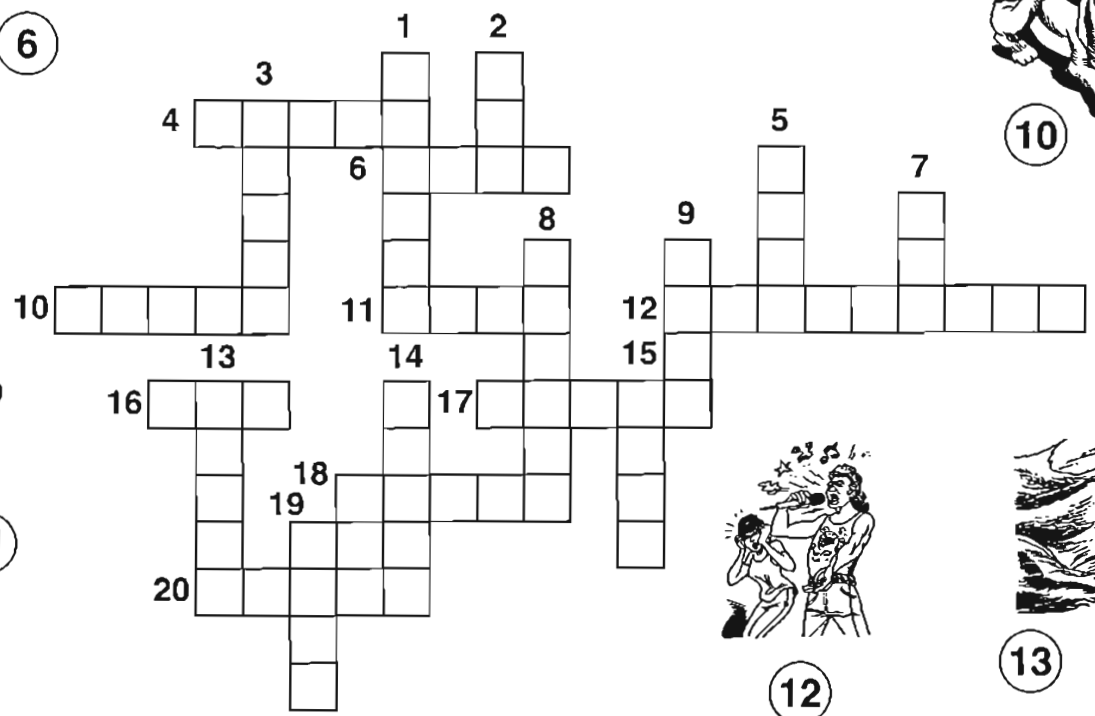

11



12



13



14



15



16



17



18



19



20

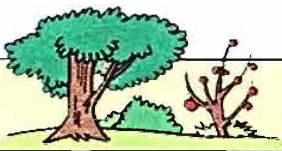

TREES AND PLANTS

page 4

apple tree
branch
cactus
cherry tree
chestnut

cypress
fir
flower
grass
holly

ivy
leaves
mimosa
oak
palm

pine
poplar
roots
trunk
weeping willow



SMALL ANIMALS

page 10

ant
bee
beetle
butterfly
caterpillar

clothes moth
cricket
dragonfly
firefly
fly

grasshopper
ladybird
lizard
millipede
mosquito

praying mantis
scorpion
snail
spider
wasp



ANIMAL FEATURES

page 16

antlers
beak
claws
coat
ears

feathers
feelers
fins
gills
hooves

legs
mane
muzzle
scales
sting

tail
talons
trunk
tusks
wings

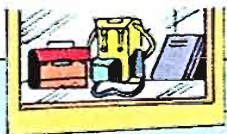

SHOPS

page 22

baker's
barber's
bookshop
boutique
butcher's

cafeteria
chemist's
fishmonger's
florist's
greengrocer's

jeweller's
hairdresser's
newsagent's
optician's
shoe shop

stationer's
supermarket
tailor's
toy shop
travel agency



CONTAINERS

page 28

barrel	bucket	paper bag	suitcase
basket	cage	petrol can	tin
bottle	crate	purse	travelbag
box	jar	rucksack	tube
briefcase	handbag	sack	wallet



SHAPES, LINES AND MEASURES

page 34

angle	curve	metre	side
circle	diagonal	oval	sphere
cylinder	diameter	pyramid	spiral
cone	kilo	radius	square
cube	litre	rectangle	triangle



MUSIC

page 40

arm	conductor	musical notes	sheet music
backing singers	disc jockey	musicians	singer
cassette	headphones	radio	sleeve
cassette player	microphone	record	speakers
compact disc player	musical instruments	record player	stylus



AT THE THEATRE

page 46

actor	box office	director	seat
actress	composer	make-up artist	set
audience	costume designer	music stand	stage
auditorium	costumes	playwright	stage lights
box	curtain	prompter	ticket



SPORTS EQUIPMENT

page 52

baseball bat

flippers

goal

skis

boxing gloves

foil

hurdle

skisticks

crash helmet

football

ice hockey stick

table tennis bat

diving mask

football boots

ice skates

tennis racket

fencing mask

glove

roller skates

weight



IN THE BATHROOM

page 58

bathrobe

hand towel

perfume

shower cap

comb

lipstick

razor

soap

face cream

mirror

scissors

sponge

hair drier

nail file

shampoo

toothbrush

hairbrush

nail varnish

shaving foam

toothpaste



THE HOSPITAL

page 64

ambulance

cotton wool

patient

surgeon

bandage

doctor

pills

surgical mask

bed

hospital

plaster

syringe

black eye

medicine

stethoscope

thermometer

bump

nurse

stretcher

wound



OUTER SPACE

page 70

astronaut

lunar buggy

orbit

shuttle

comet

meteor

planet

space station

earth

module

radio telescope

space suit

galaxy

moon

rocket

stars

launch pad

optical telescope

satellite

sun



VERBS

page 76

act	comb	kneel	ride
break	cut	measure	sit down
buy	dive	plant	stand up
catch	dress	play	swim
clap	fly	prune	wash



ADJECTIVES

page 82

calm	hard	noisy	rough
clean	heavy	odd	soft
dirty	in tune	out of tune	tidy
dry	left	quiet	untidy
even	light	right	wet



An entertaining and effective way to learn new vocabulary.

- Illustrated words make meaning immediate.
- New words are reinforced and recycled in a series of picture crosswords.
- Suitable for self-study or class work.
- Learning English with crosswords is easy and fun!

In this series:

ENGLISH WITH CROSSWORDS 1 Beginners

ENGLISH WITH CROSSWORDS 2 Intermediate

ENGLISH WITH CROSSWORDS 3 Advanced

The series is published in the following language versions:

French: le FRANÇAIS par les MOTS CROISÉS

German: mit KREUZWORTRÄTSELN DEUTSCH lernen

Spanish: el ESPAÑOL en CRUCIGRAMAS

Italian: l'ITALIANO con le PAROLE CROCIATE

ISBN 88-85148-23-9



9 788885 148239