



ENGLISH with **CROSSWORDS**



EUROPEAN LANGUAGE INSTITUTE



W

elcome to **English with Crosswords Book 2**. Following

the success of the first volume here is another collection of carefully chosen picture crosswords. As in Book 1 all words are presented in theme groups and are colourfully illustrated to promote immediate understanding and

learning. Language teachers all over the world agree that visual material can significantly aid the comprehension of new vocabulary. Pictures provide context and unambiguous meaning, thereby allowing students to learn and remember words more easily.

20 words are introduced in each theme and practised in a series of 5 crosswords. Meaning is reinforced through word-picture association and words are recycled through repeated practice.

In the first crossword students write the words corresponding to 10 illustrations in the crossword grid. In the second crossword the remaining 10 words are practised.

In the third crossword a mixture of words from the first two crosswords is used and in the fourth one there is a mixture of the other 10 words.

All 20 words are then brought together in the final crossword.

English with Crosswords Book 2 is ideal for self-study or as a holiday refresher.

Learning English is easy and fun!



AT THE SEASIDE



beach



sea



boat



shells

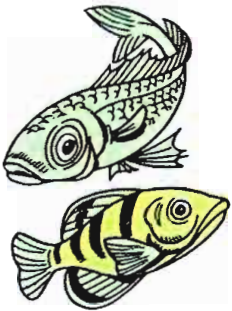

fish



fisherman



swimming costumes



deck chair



beach umbrella



beach towel



flippers



mask

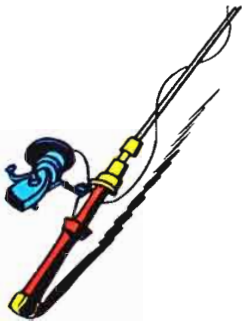

fishing rod



sun hat



sunglasses



lighthouse



pier



sand-castle



island



waves

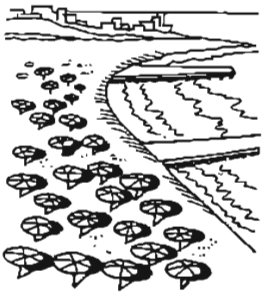
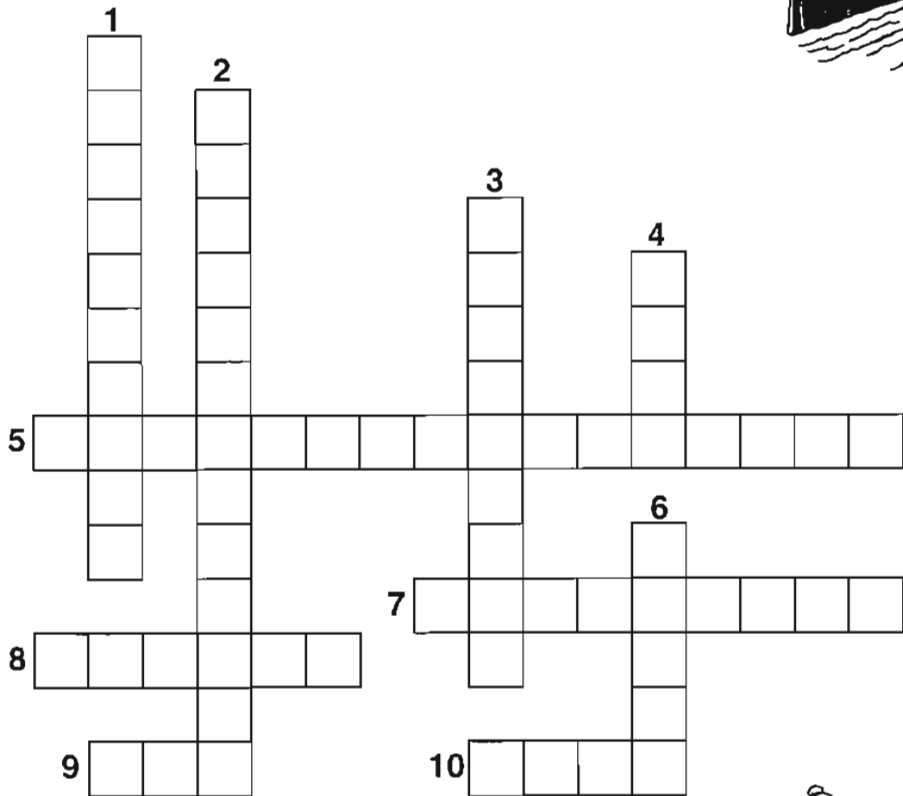
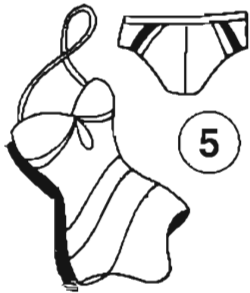
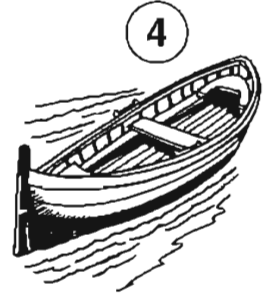
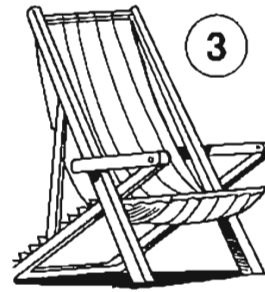
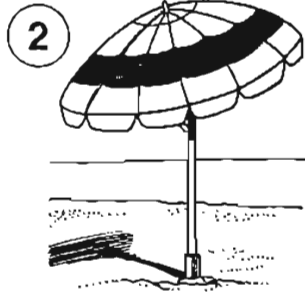
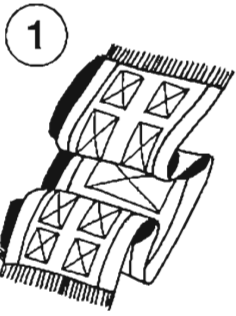

6

7

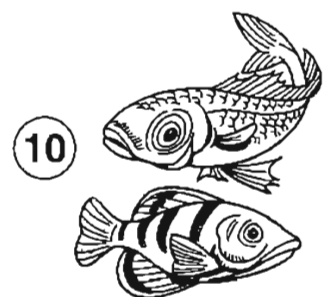

8

9

10

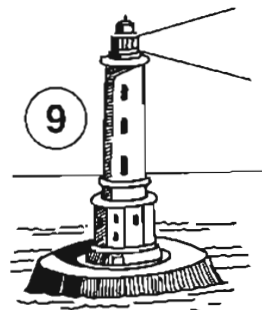
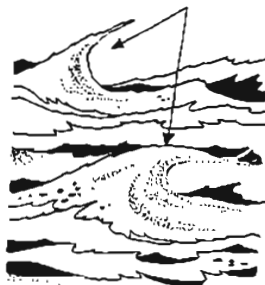
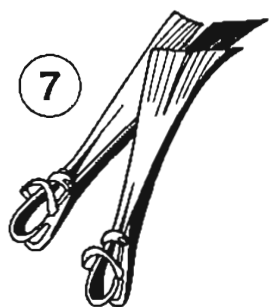
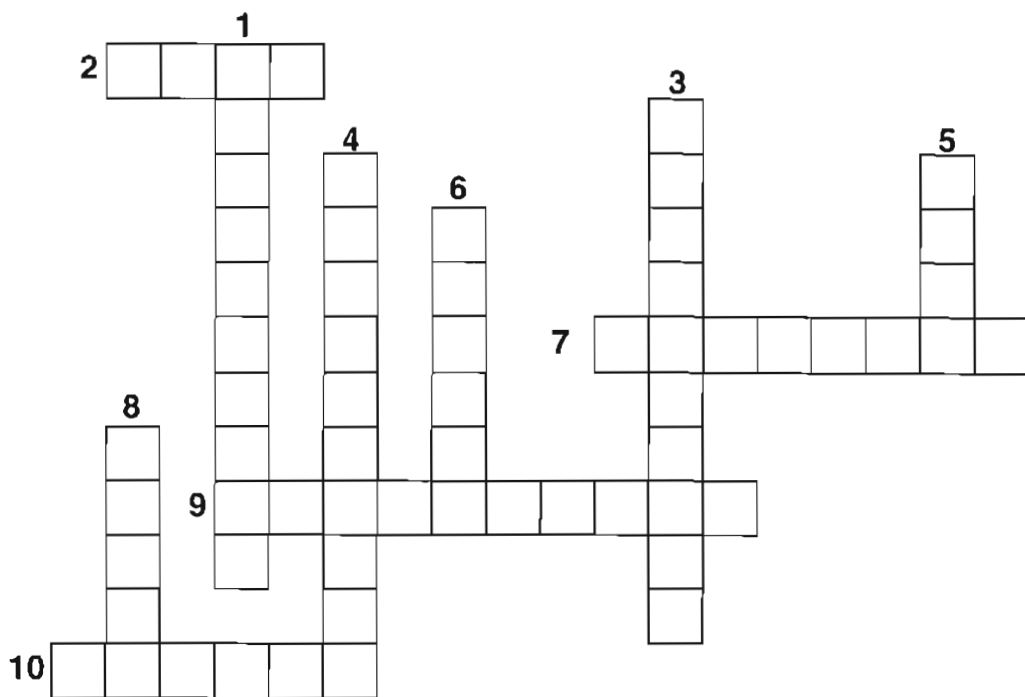
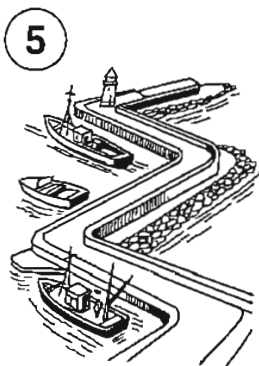
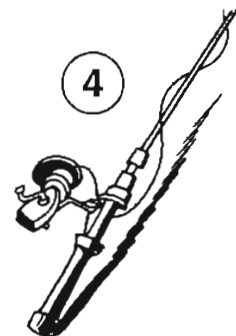
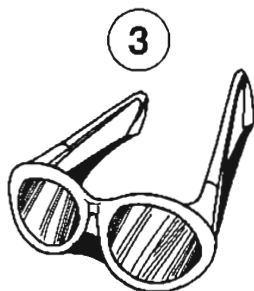
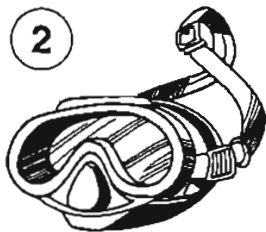

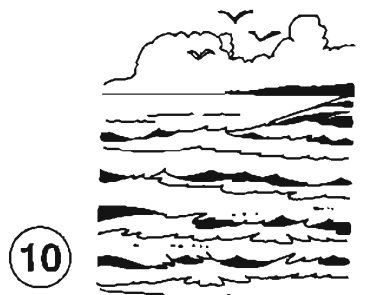
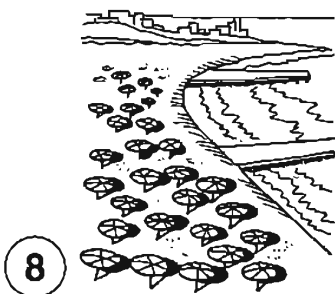
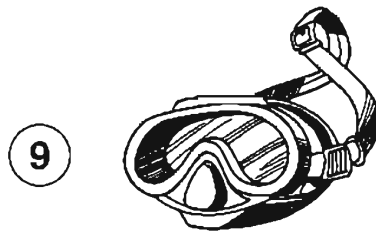
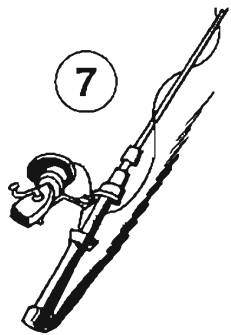
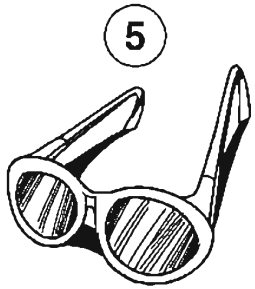
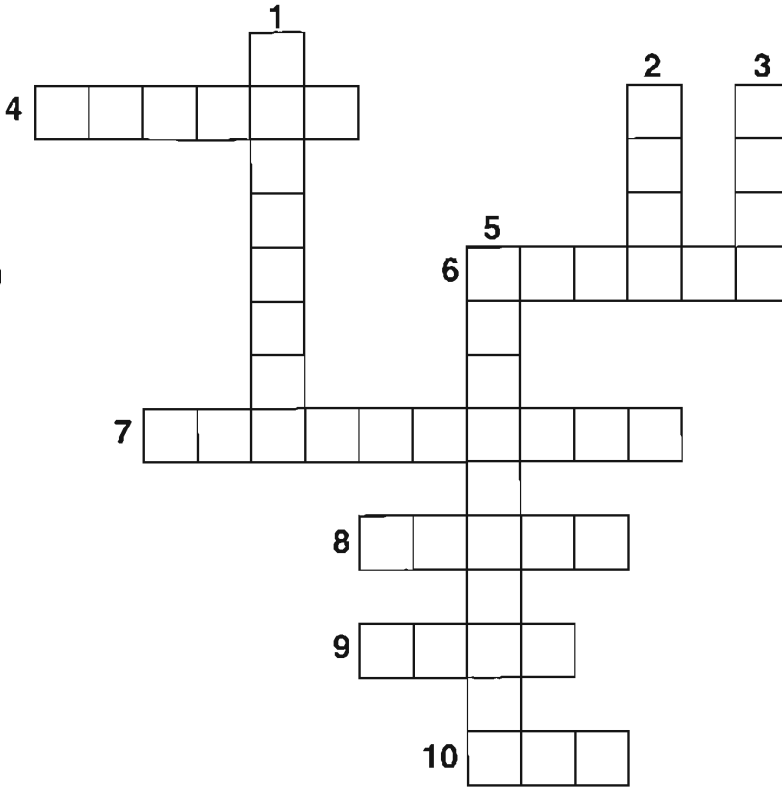
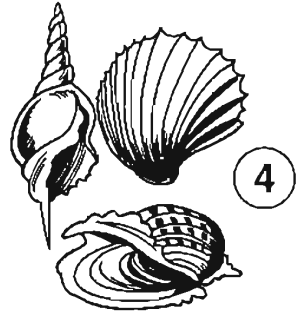
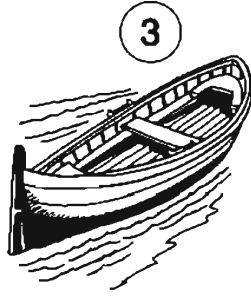
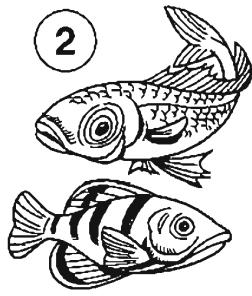
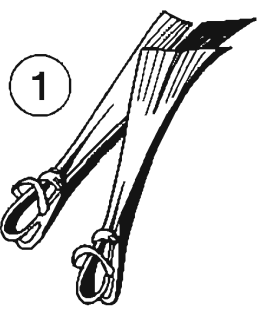

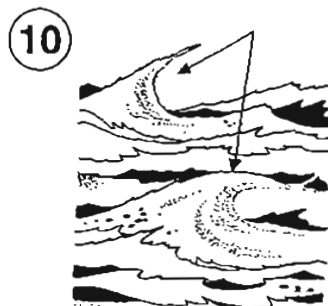
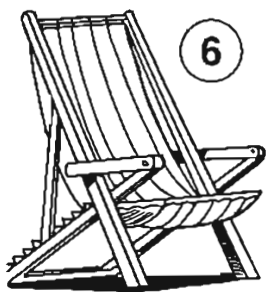
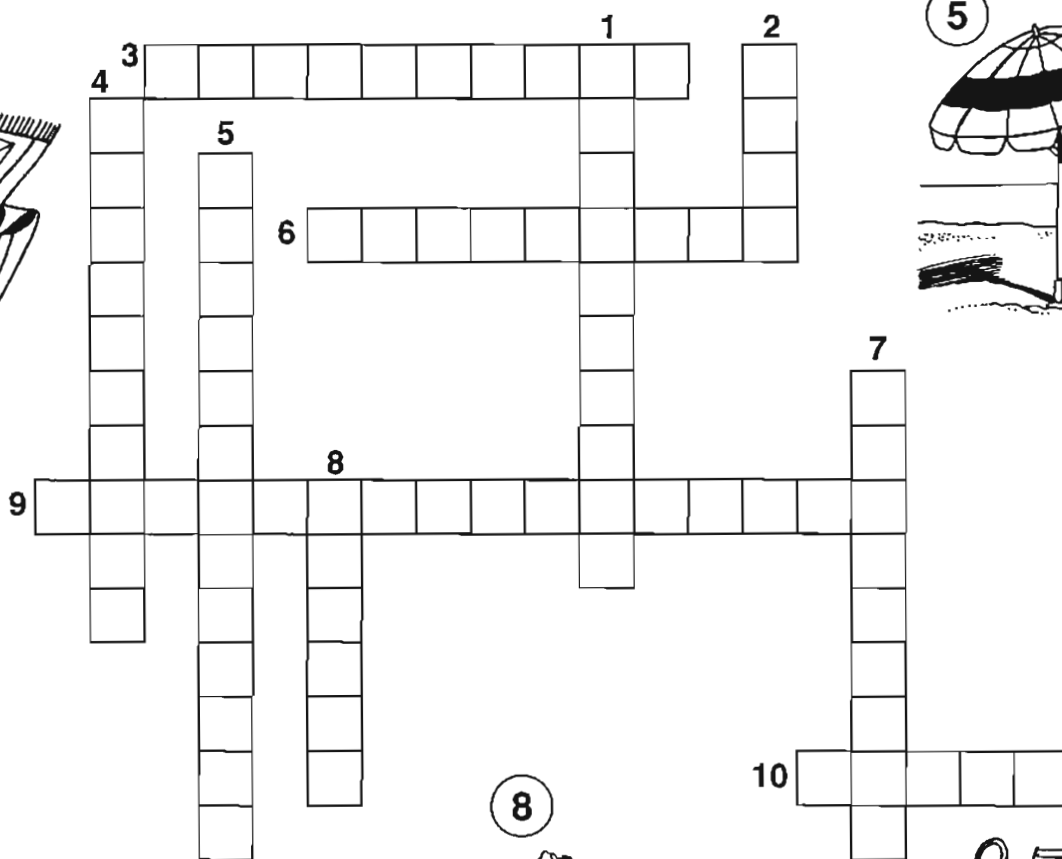
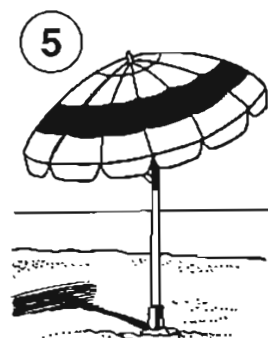
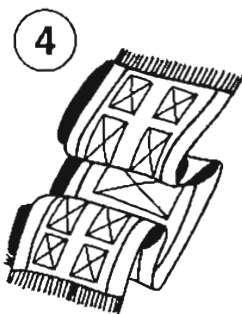
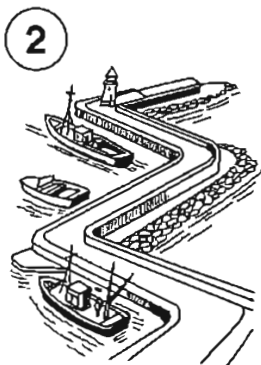
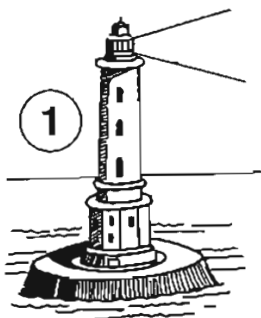

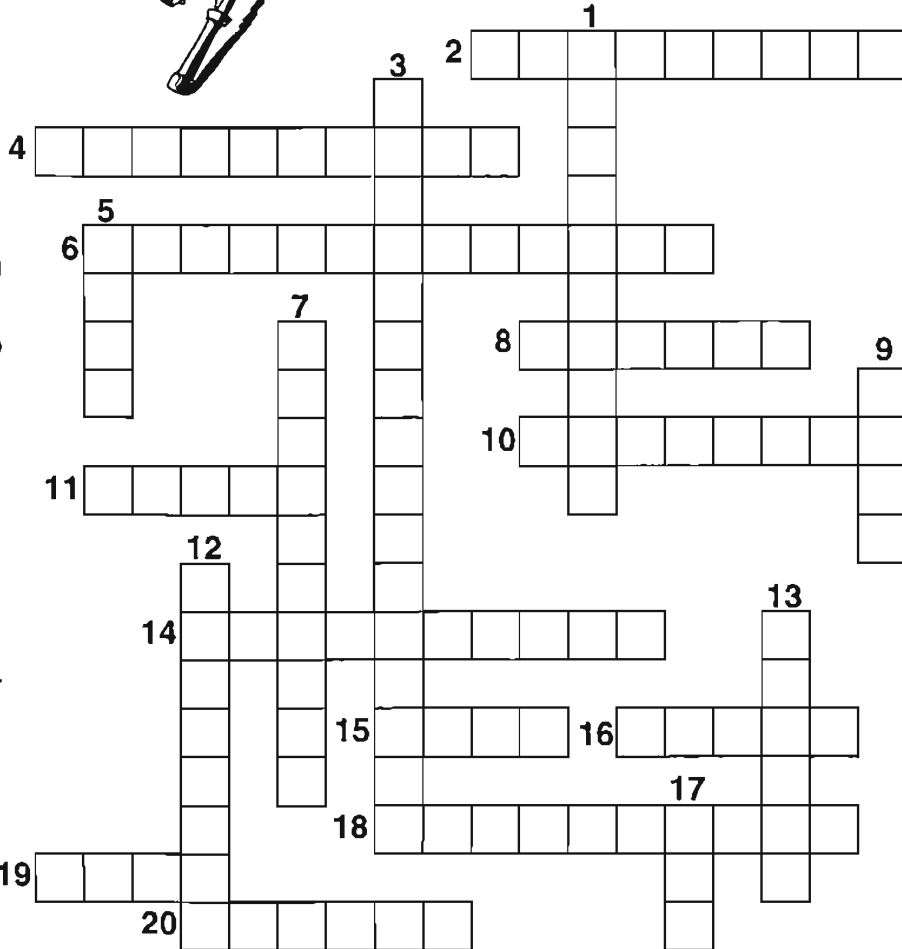
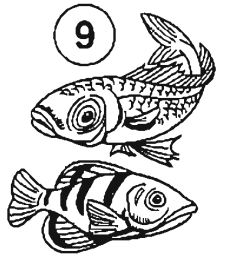
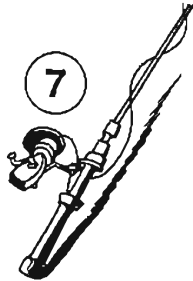
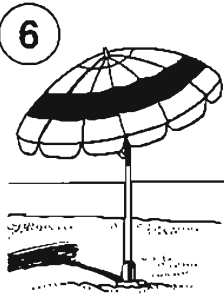
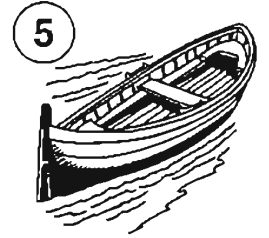
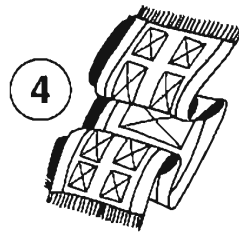

11

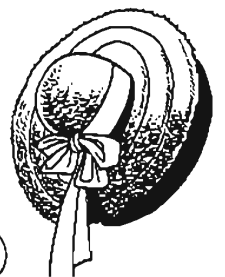
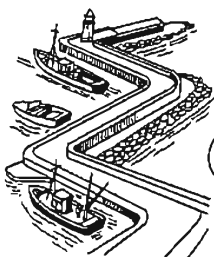
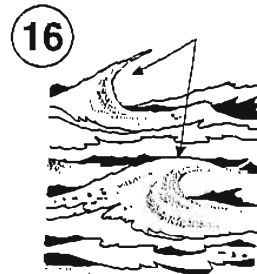
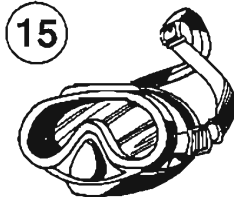
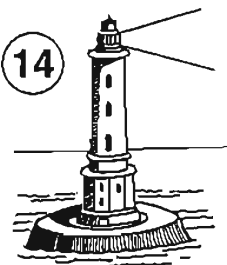
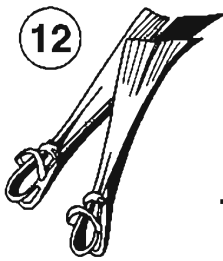
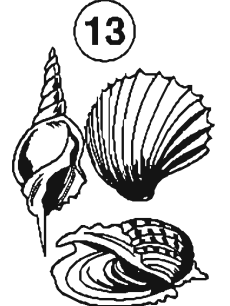
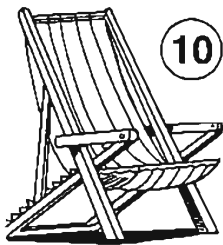
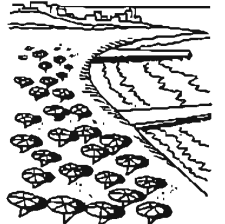



SEA FRIENDS



whale

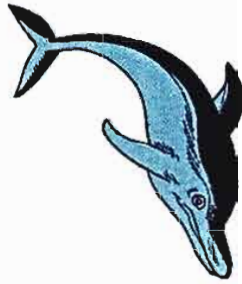

dolphin



shark



turtle



octopus



jellyfish

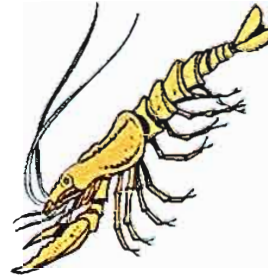

prawn



crab



lobster



sole

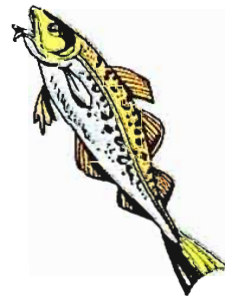

cod

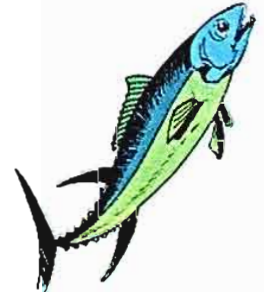

tuna



sword fish

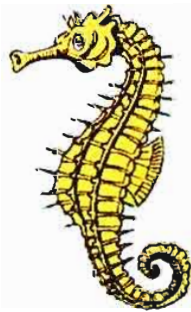

sea horse



skate



hammerhead shark



sea urchin



killer whale



herring



starfish

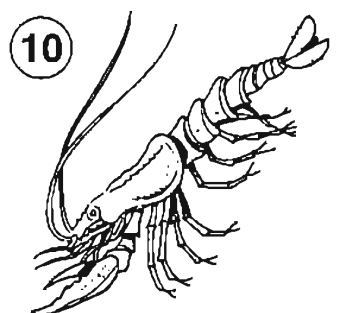
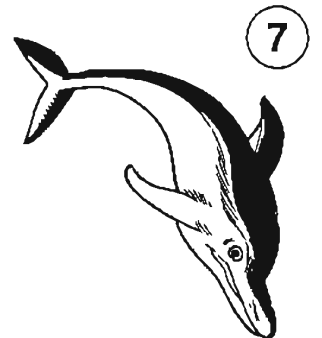
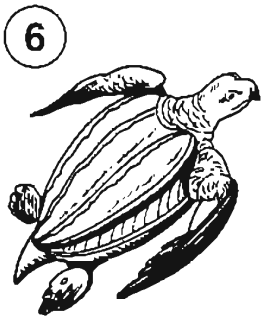
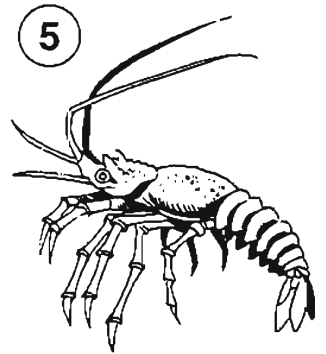
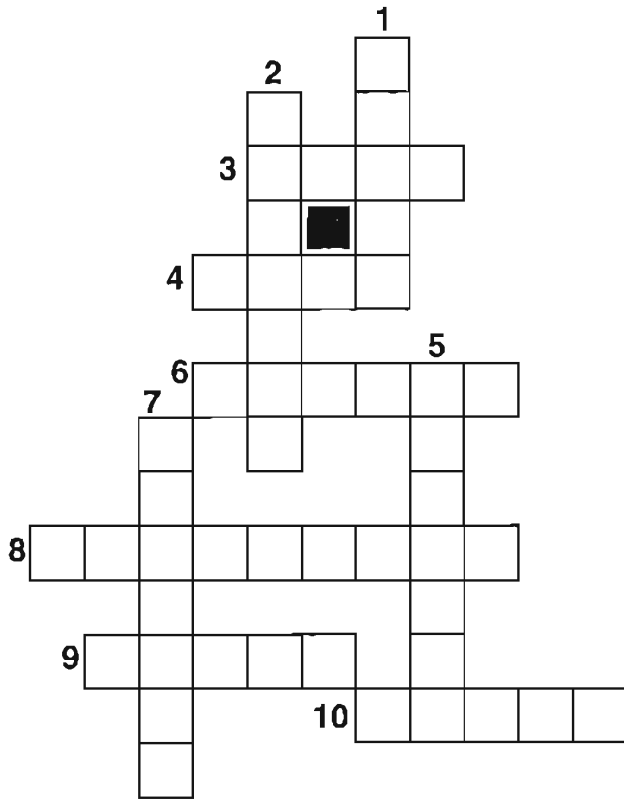
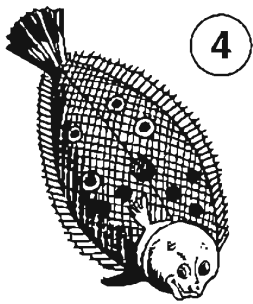
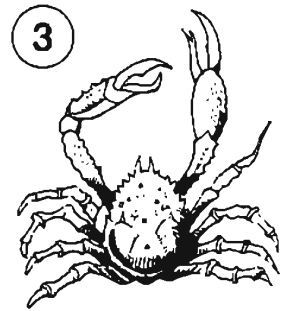

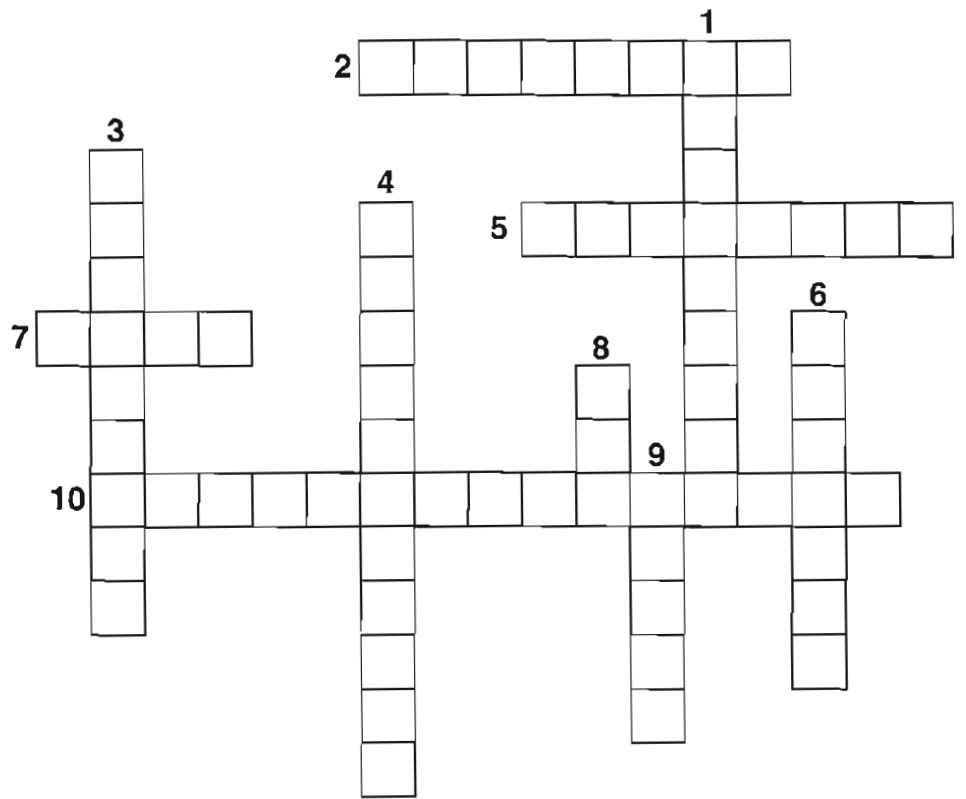
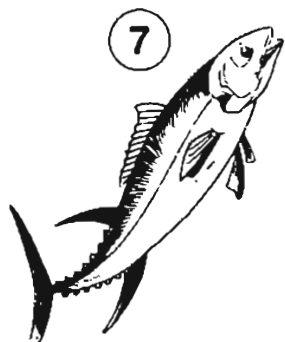
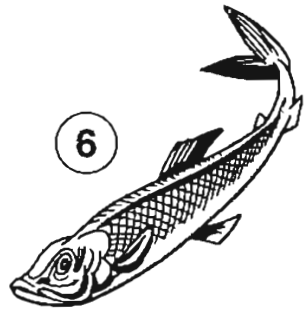
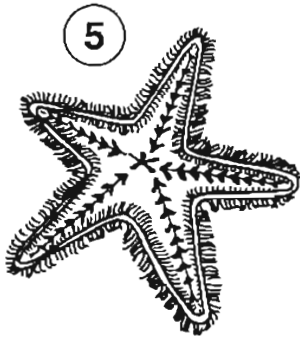
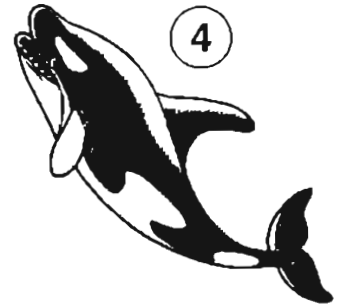
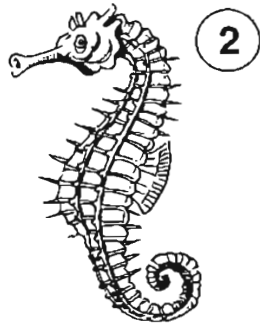

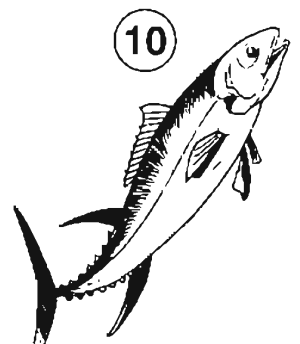
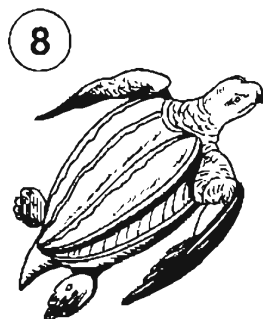
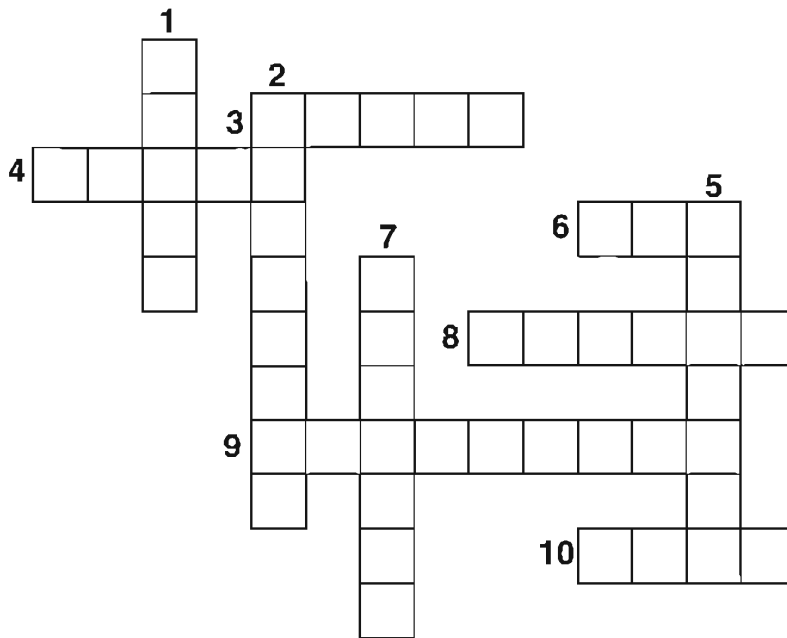
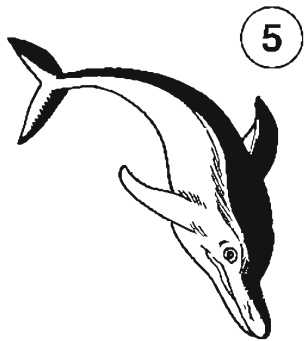
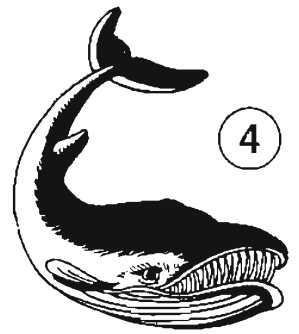
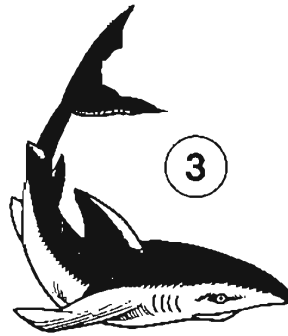
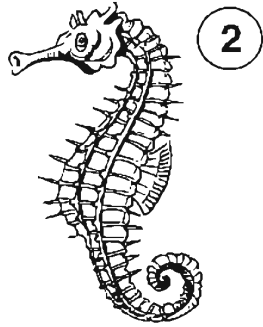

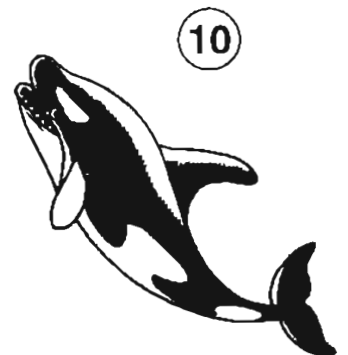
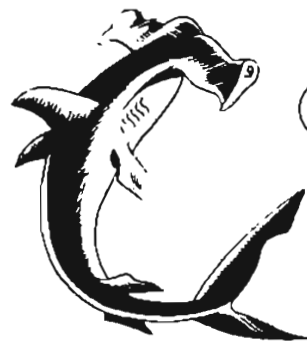
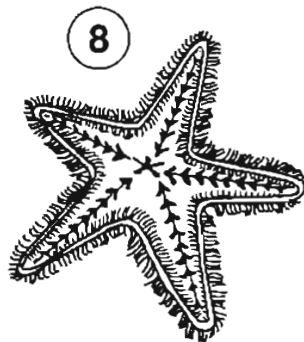
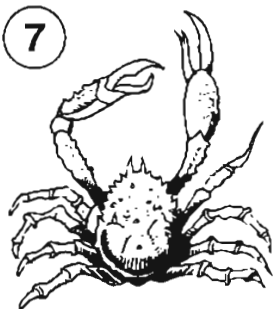
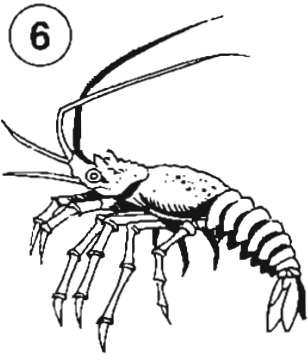
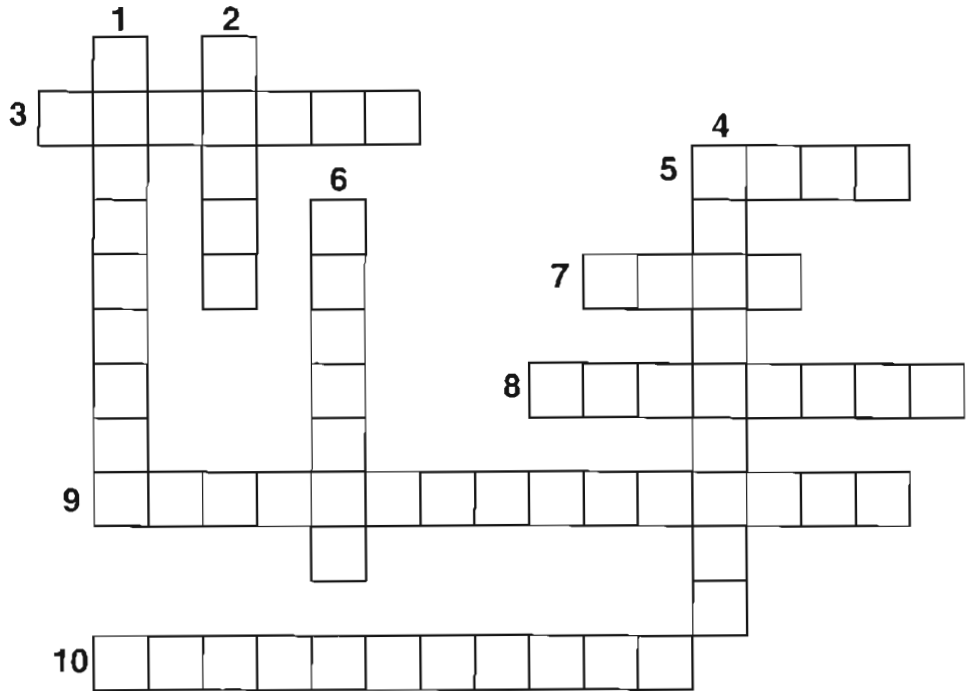
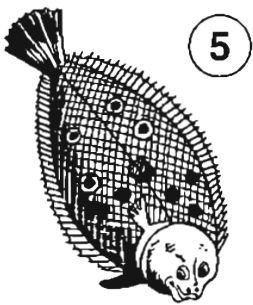
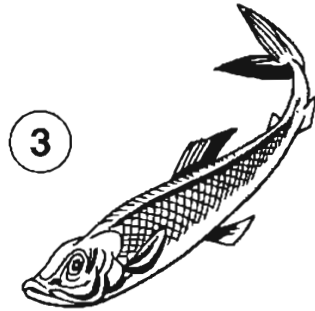
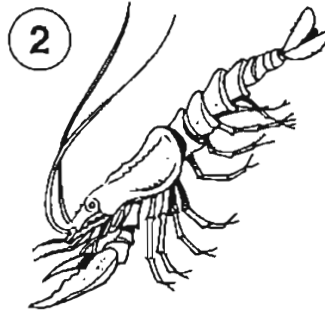



1

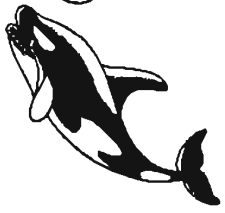

3



4



5

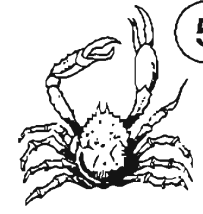

2

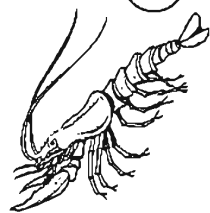

6



7



8



9

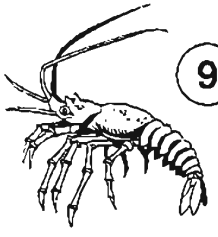

10

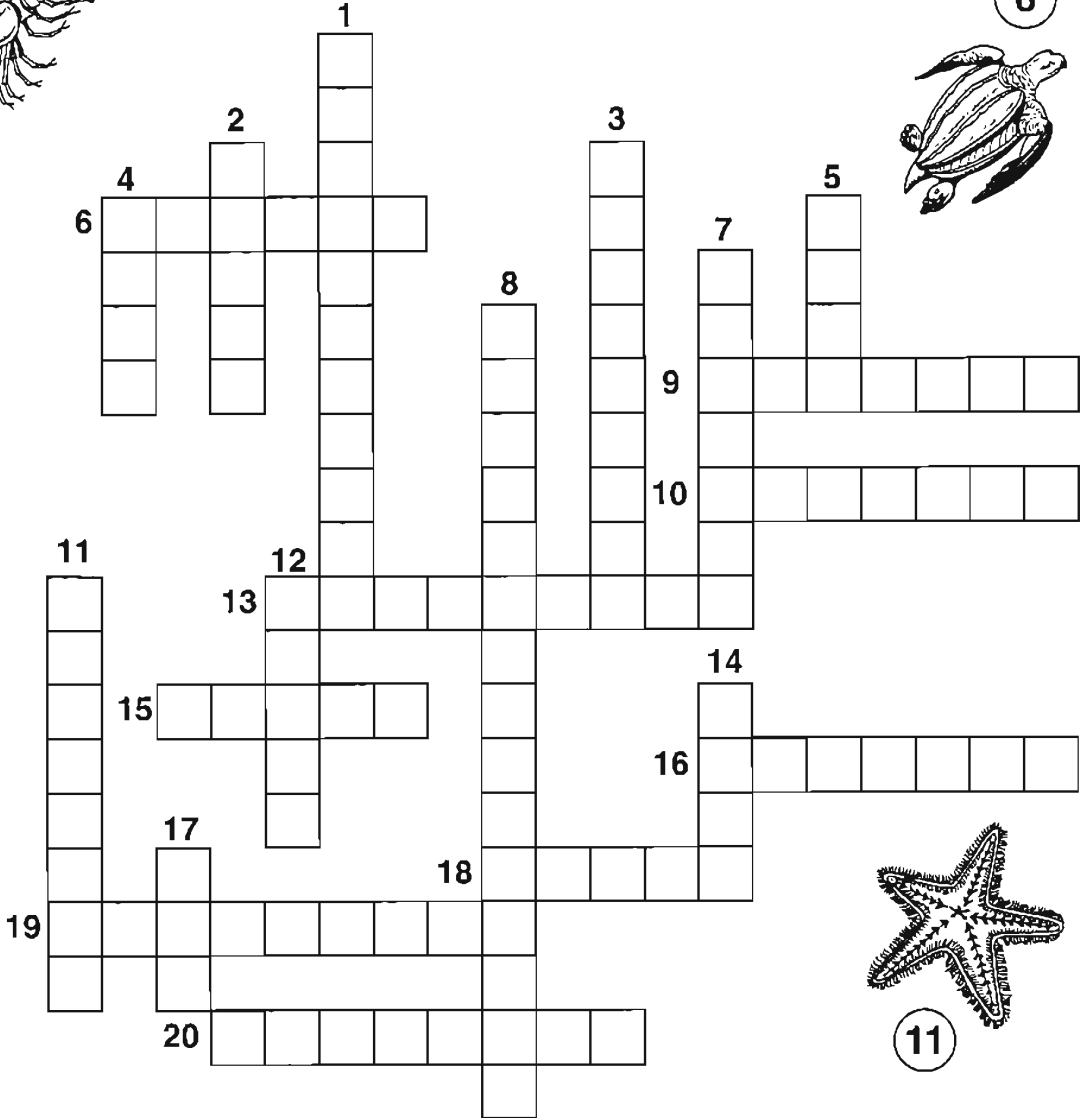

11

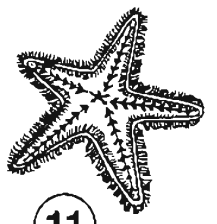

12



13



14



15



16



17



18



19



20

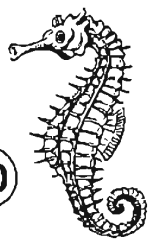



AT THE PORT AND THE RAILWAY STATION



ship



bow

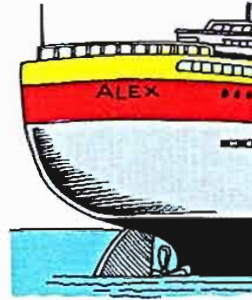

stern



gangway



captain



sailor



deck



cabin



lifeboat



anchor



train

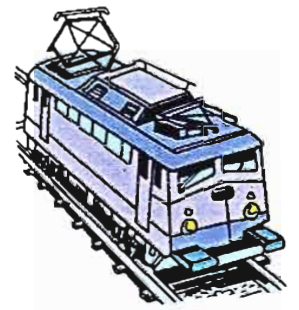

engine



engine-driver

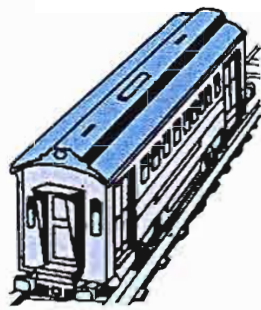

carriage



window



ticket collector



stationmaster

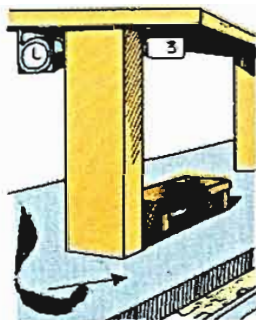

platform

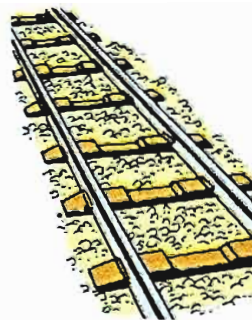

rails

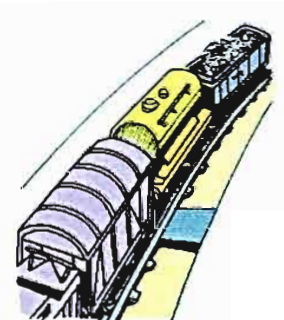

goods train

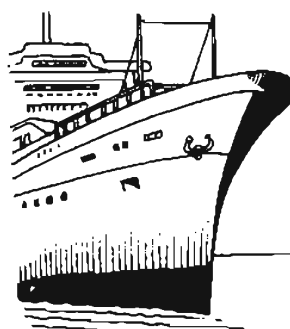
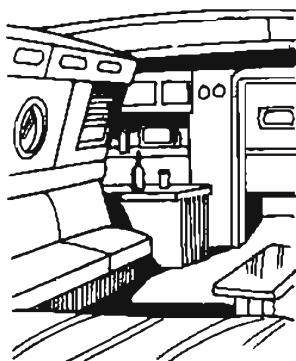
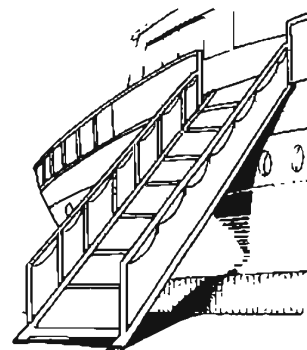
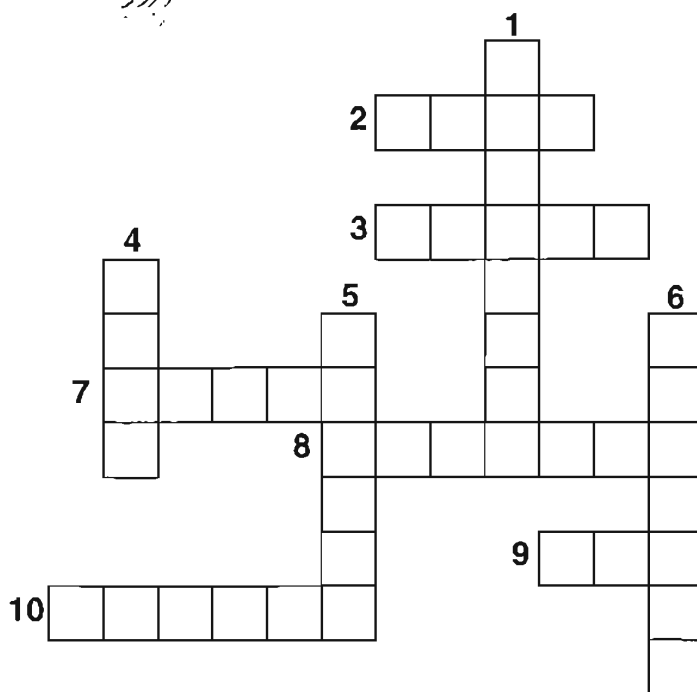
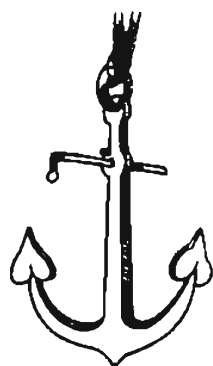
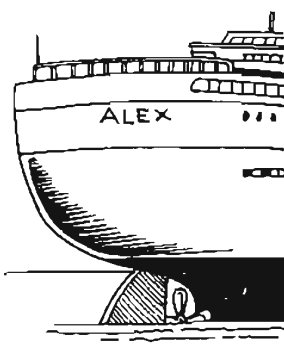
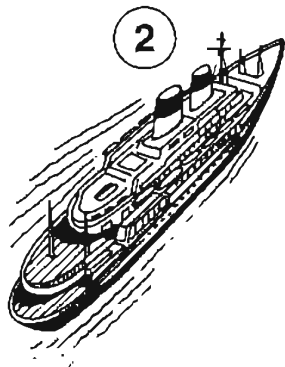
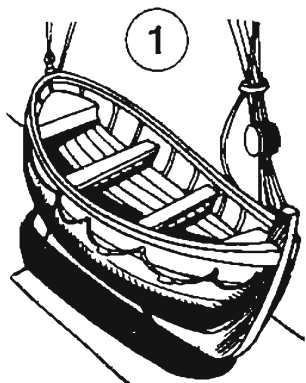



1



2

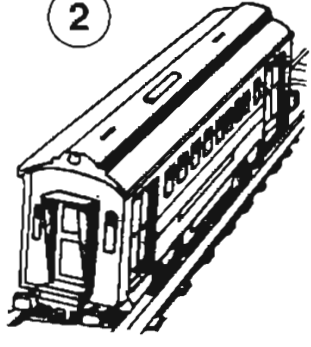

3

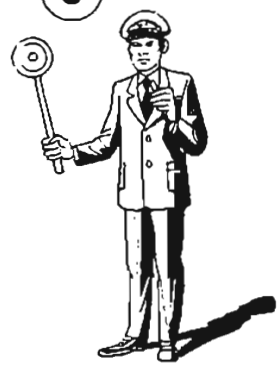

4

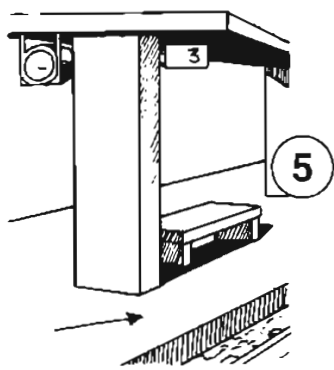
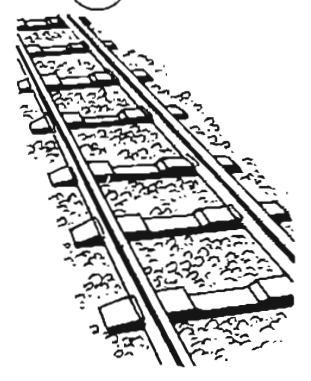

6

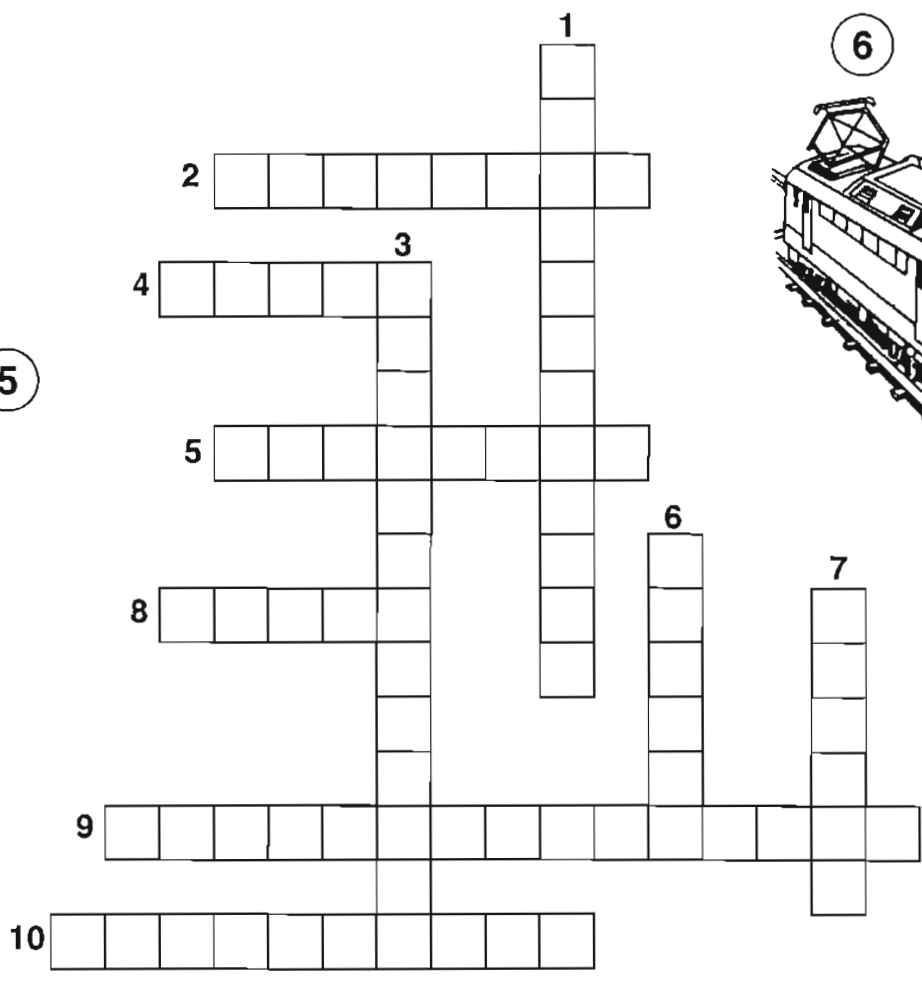
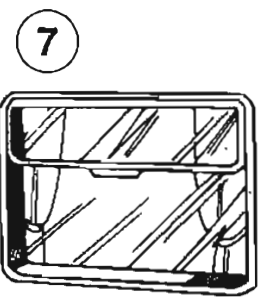
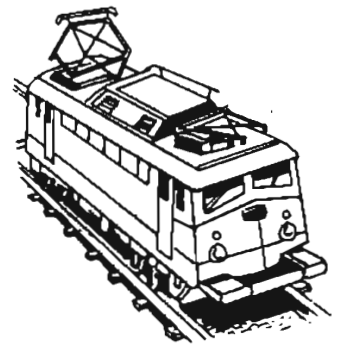

8

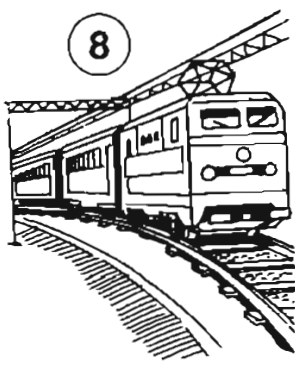

9



10

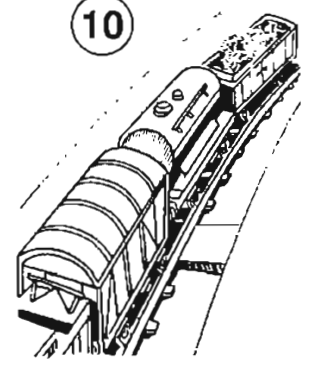

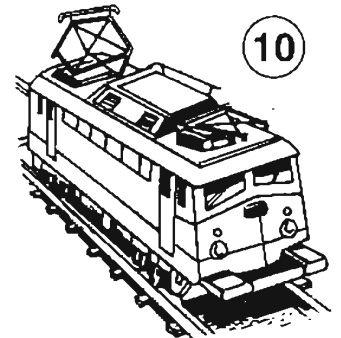
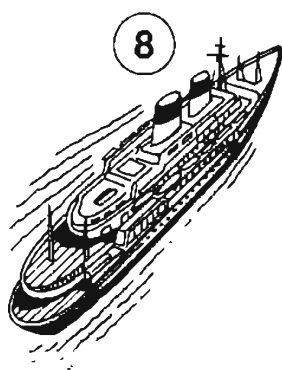
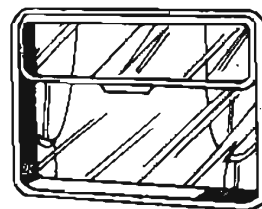
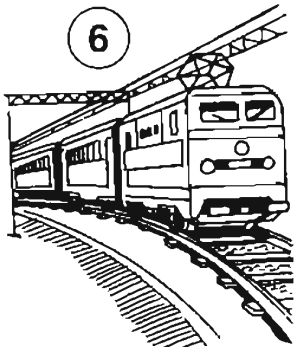
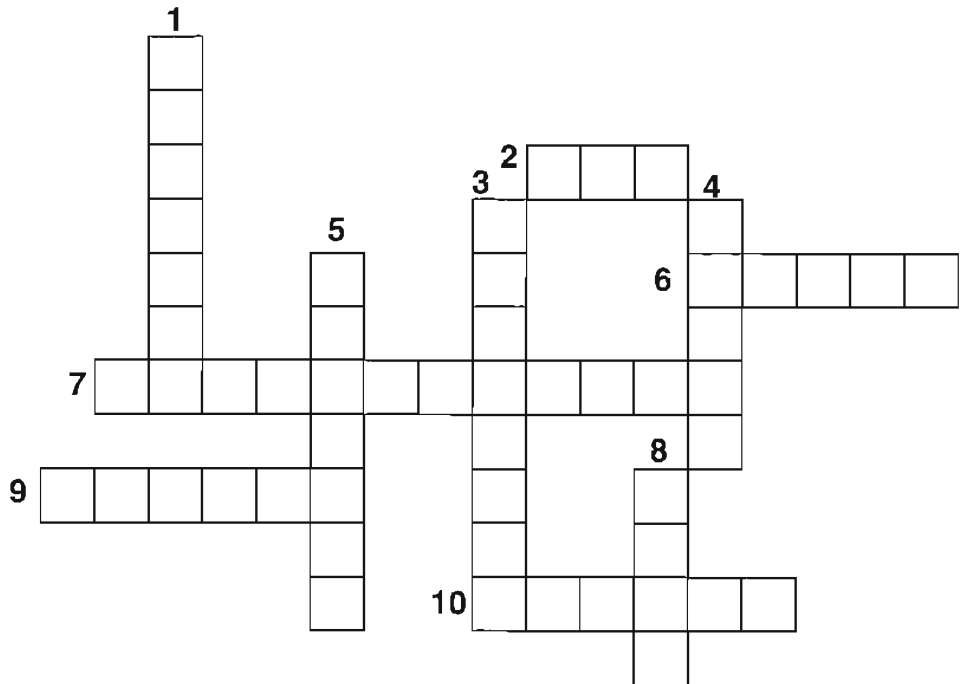
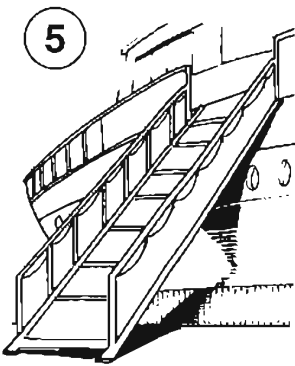
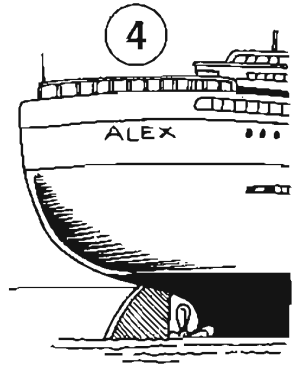
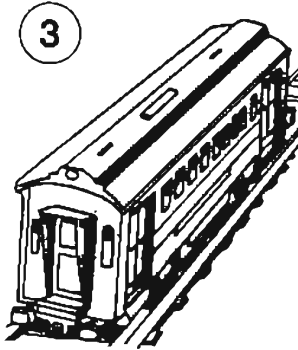
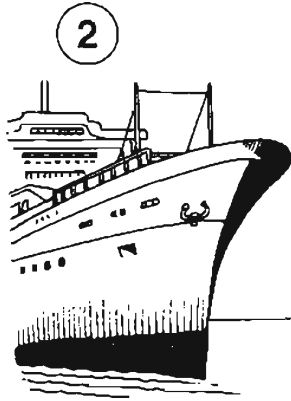
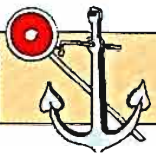

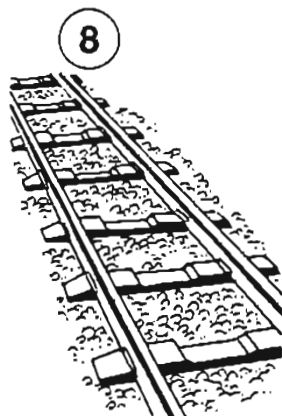
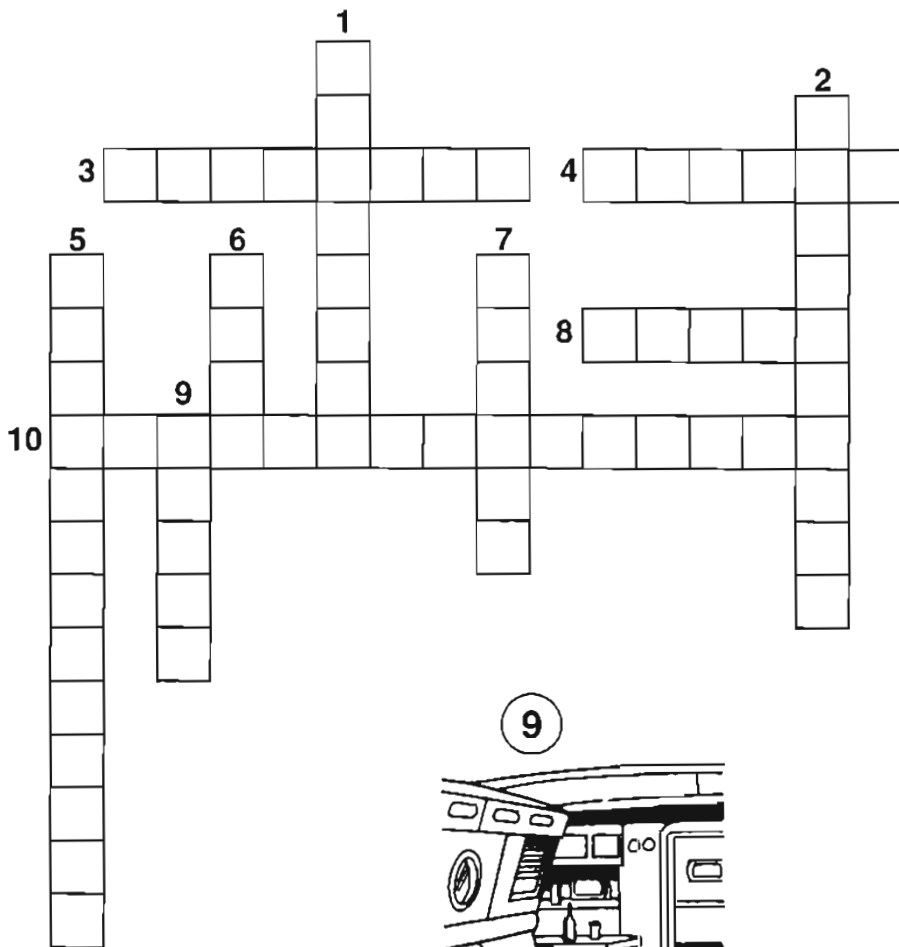
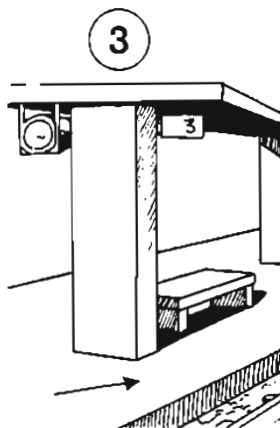
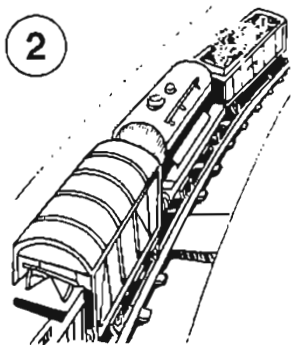
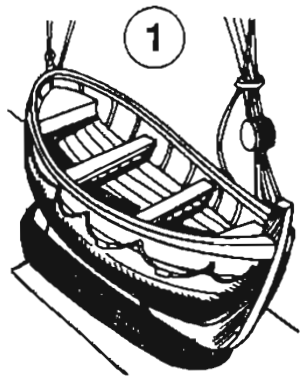

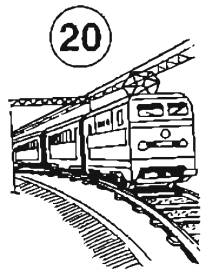
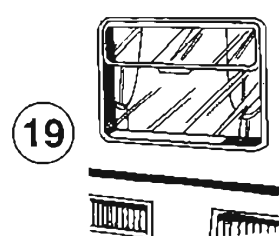
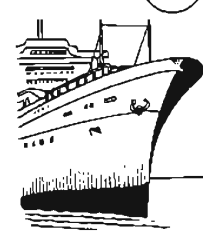
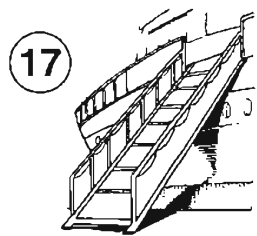
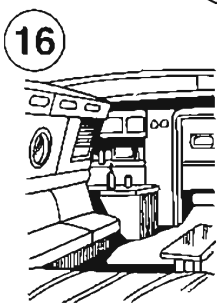
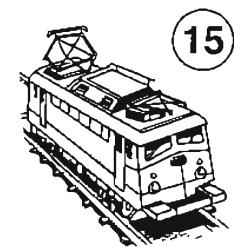
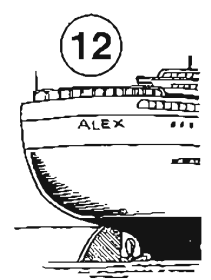
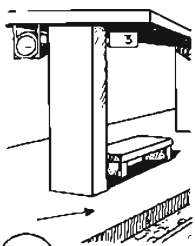
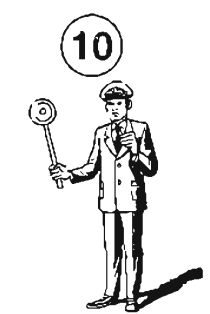
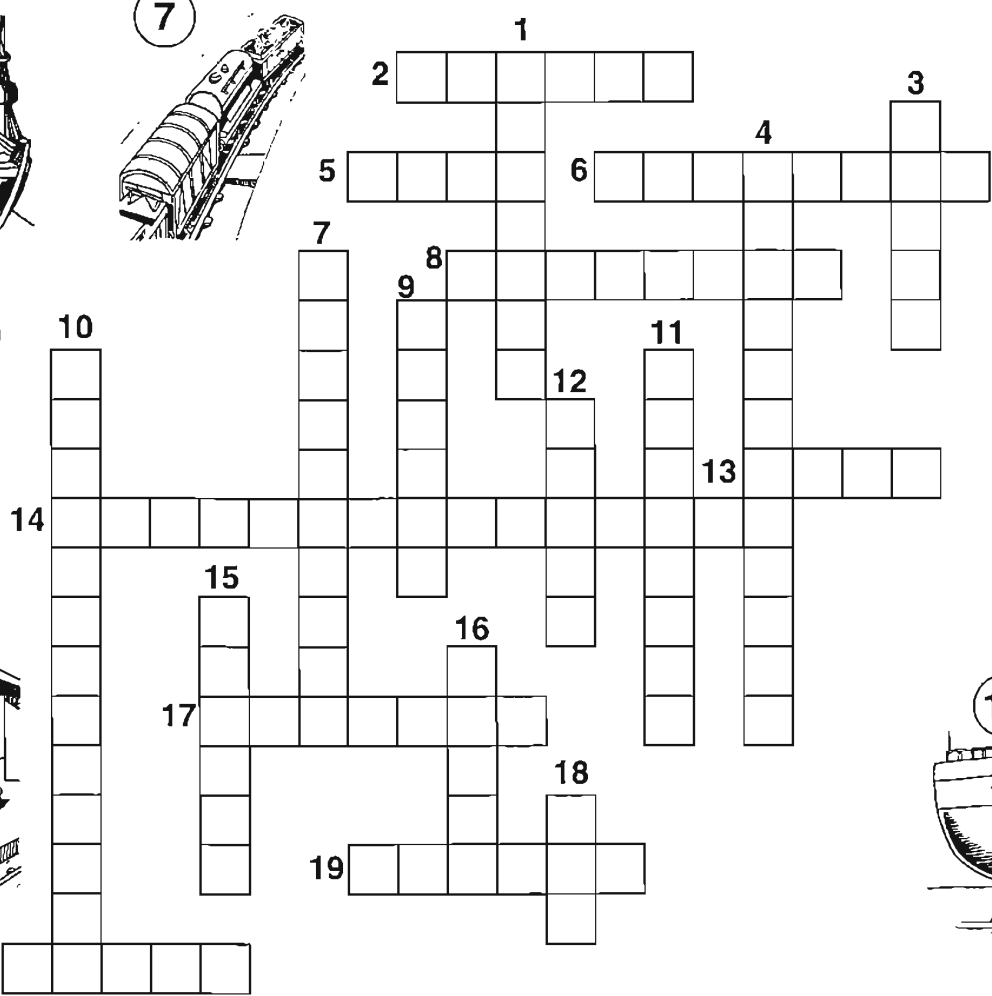
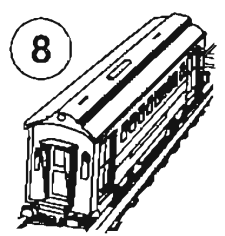
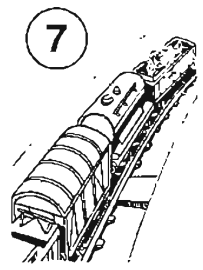
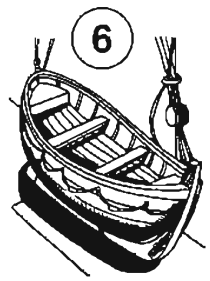
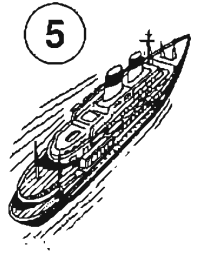
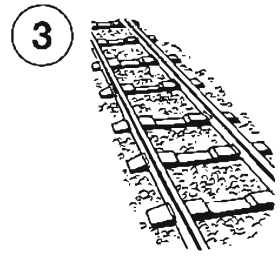
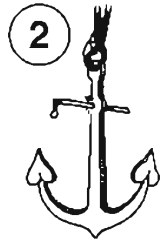



FEATURES



hair



head



face



forehead



eyebrow



eyelashes



eye



nose



cheeks



jaw



ears



ear lobe



mouth



lip



teeth



tongue



chin



neck



beard



moustache

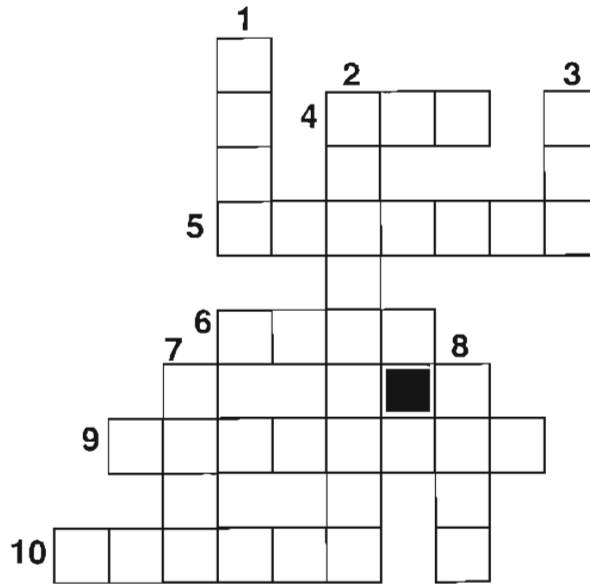

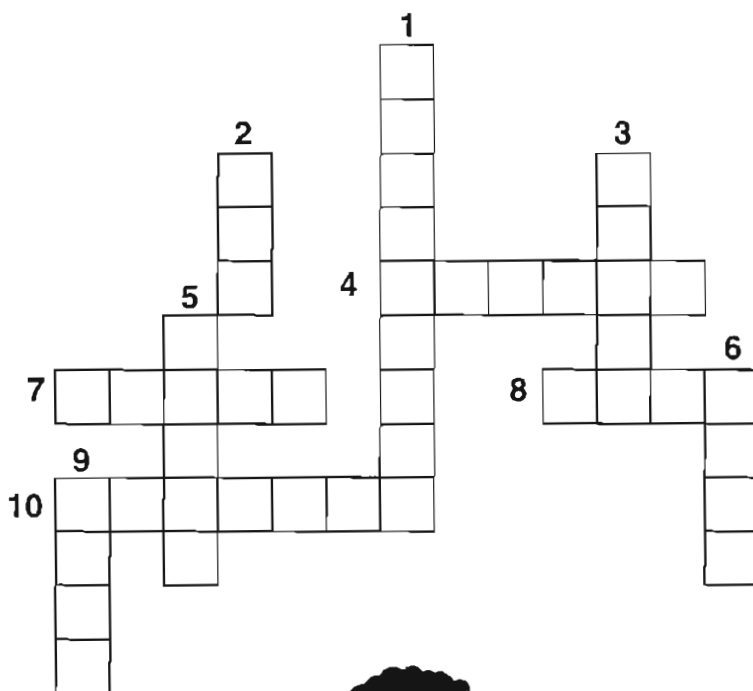

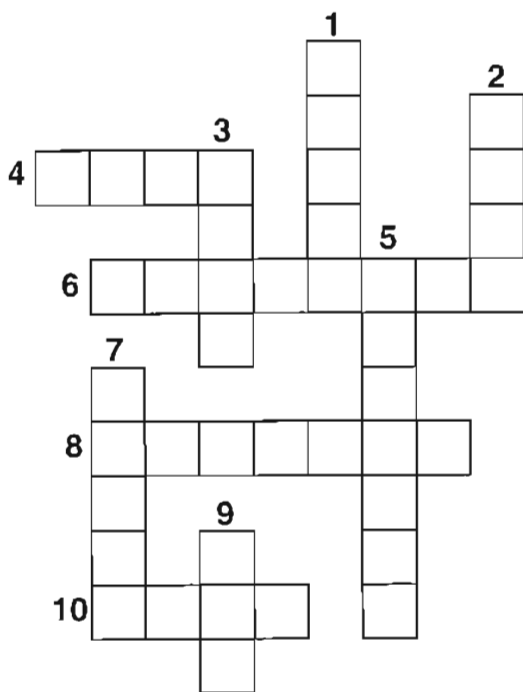
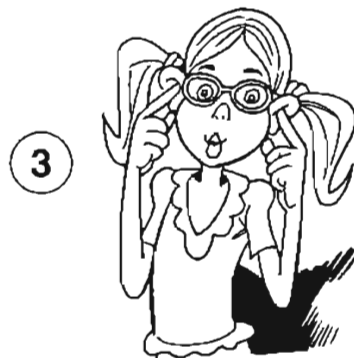

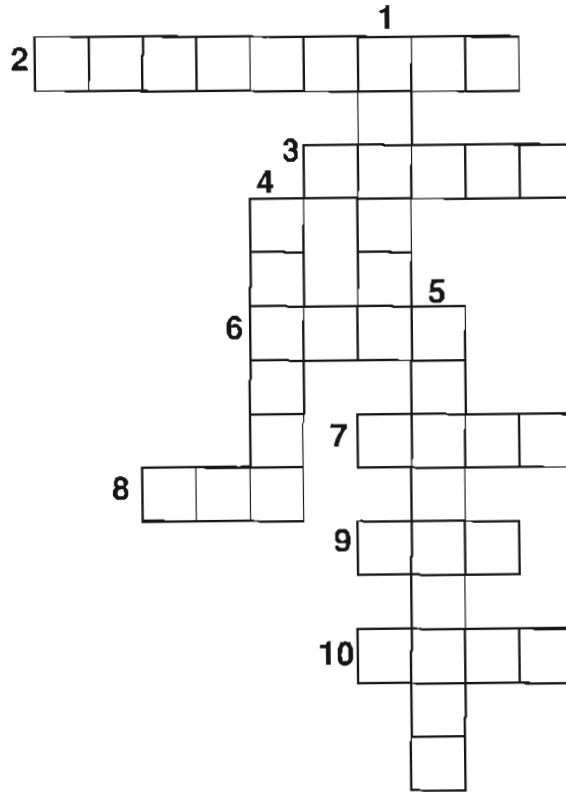

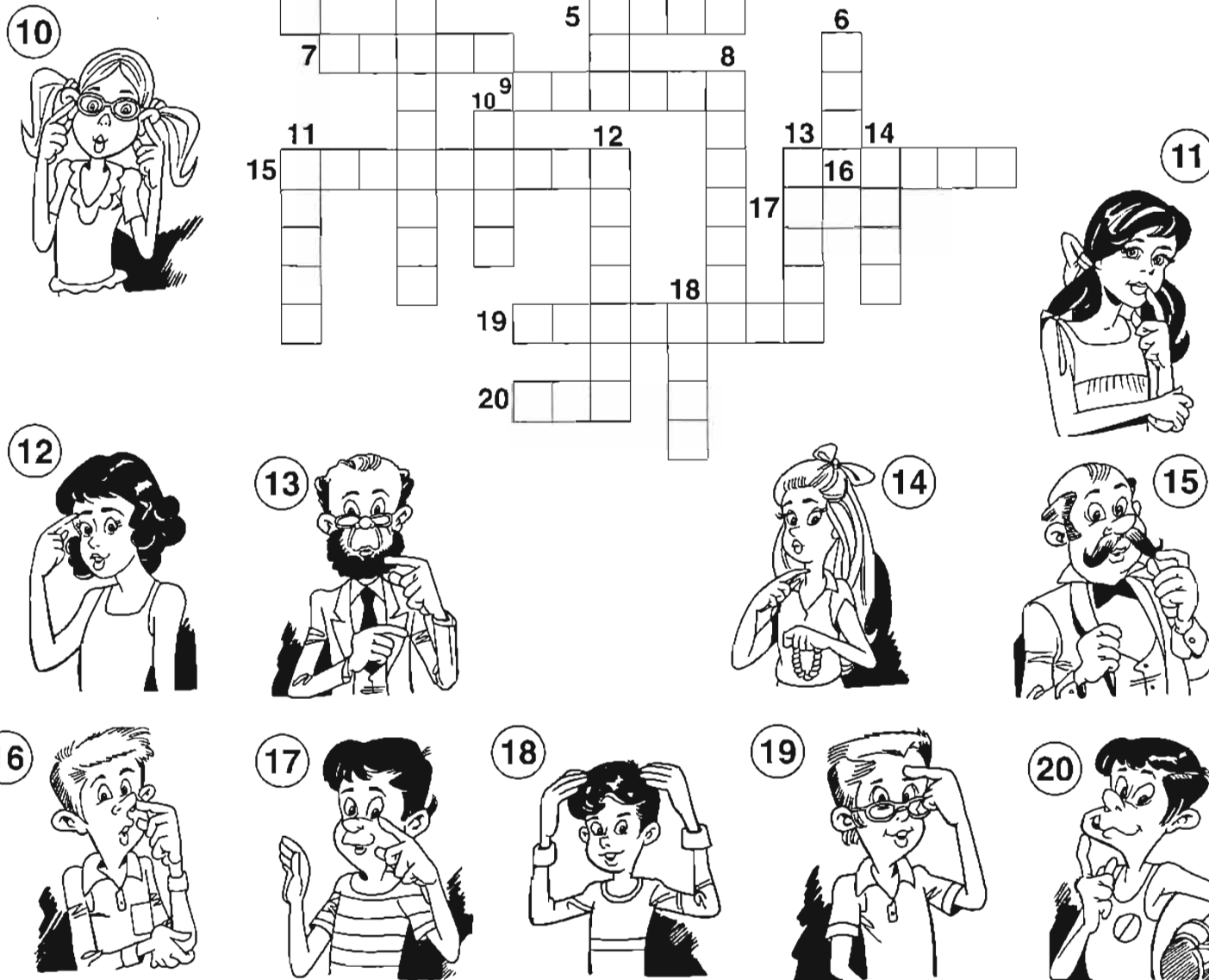
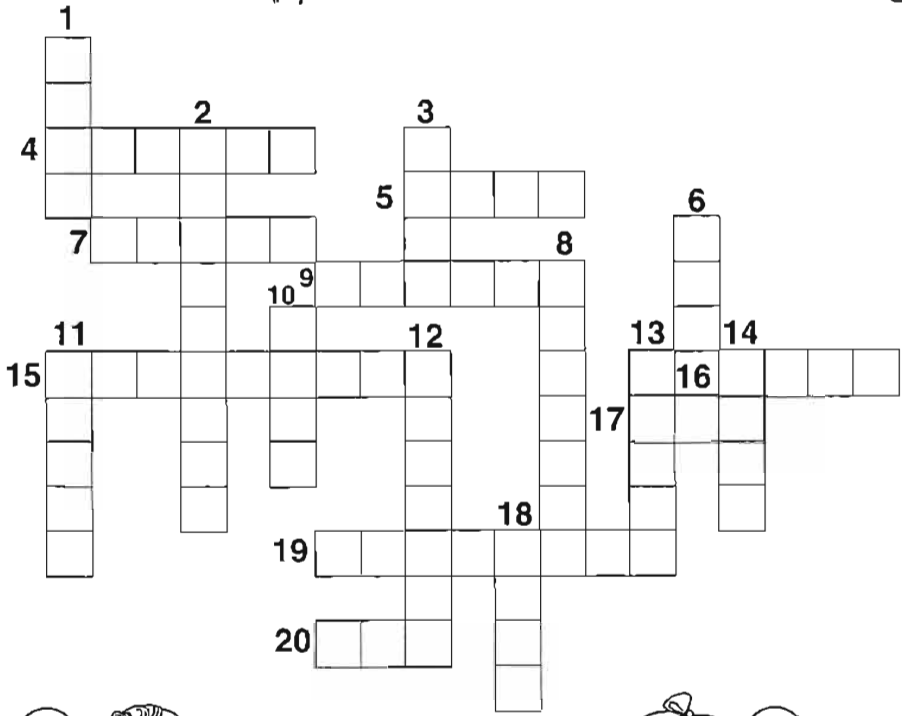



THE BODY



shoulders



forearm



arms



elbow



wrist



hands



fingers



thumbs



chest



stomach



waist



back



legs



thighs



knees



calves



ankles



feet



heels ↑



toes

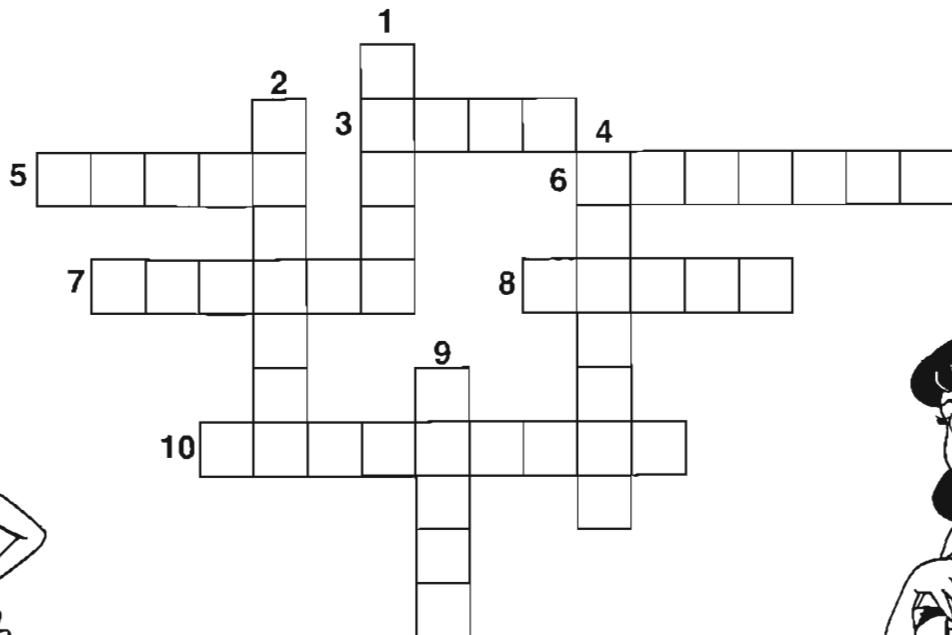

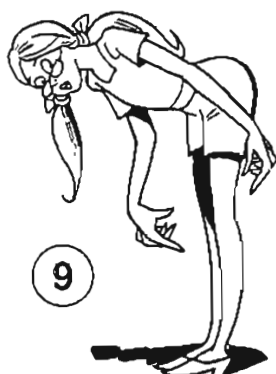
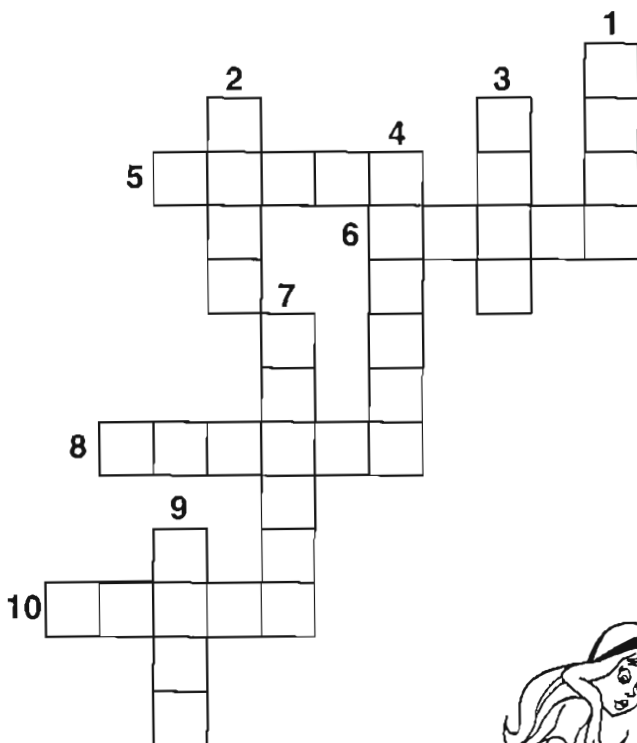

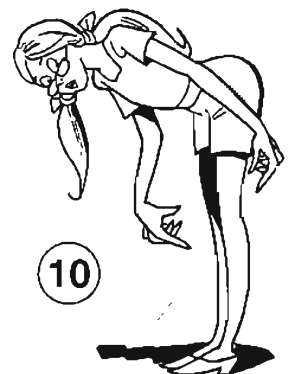
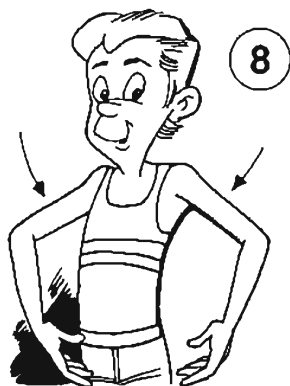
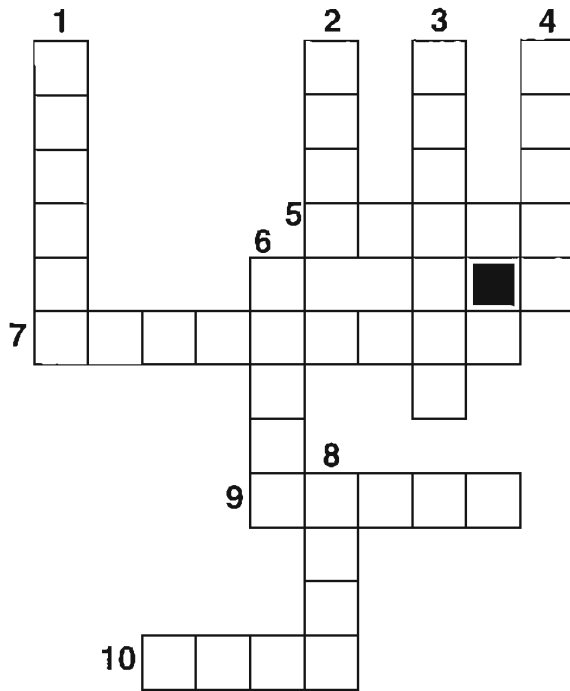

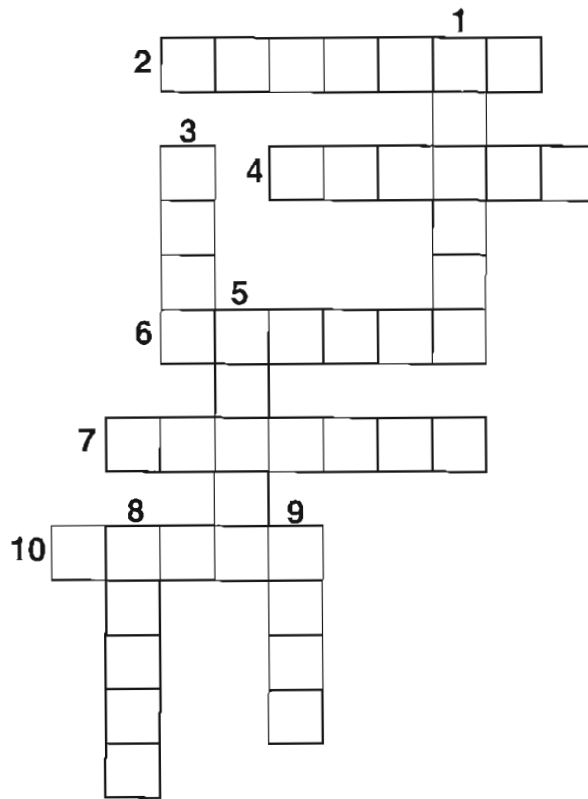

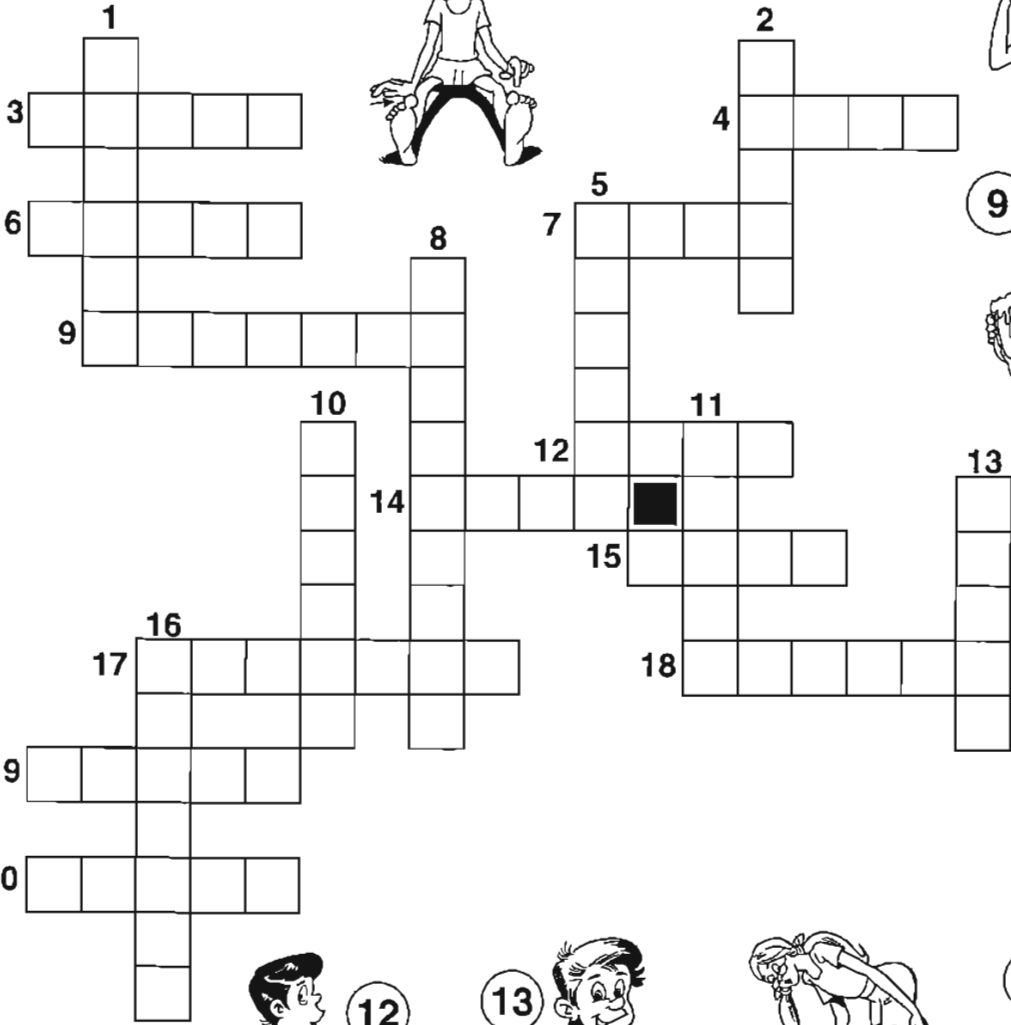



JOBS



postman



bricklayer



shop assistant



secretary



vet



mechanic



farmer



carpenter



doctor



hairdresser



cook



fireman



waiter



teacher



factory worker



clerk



electrician



plumber



singer



housewife

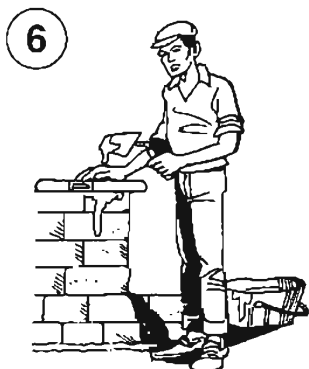
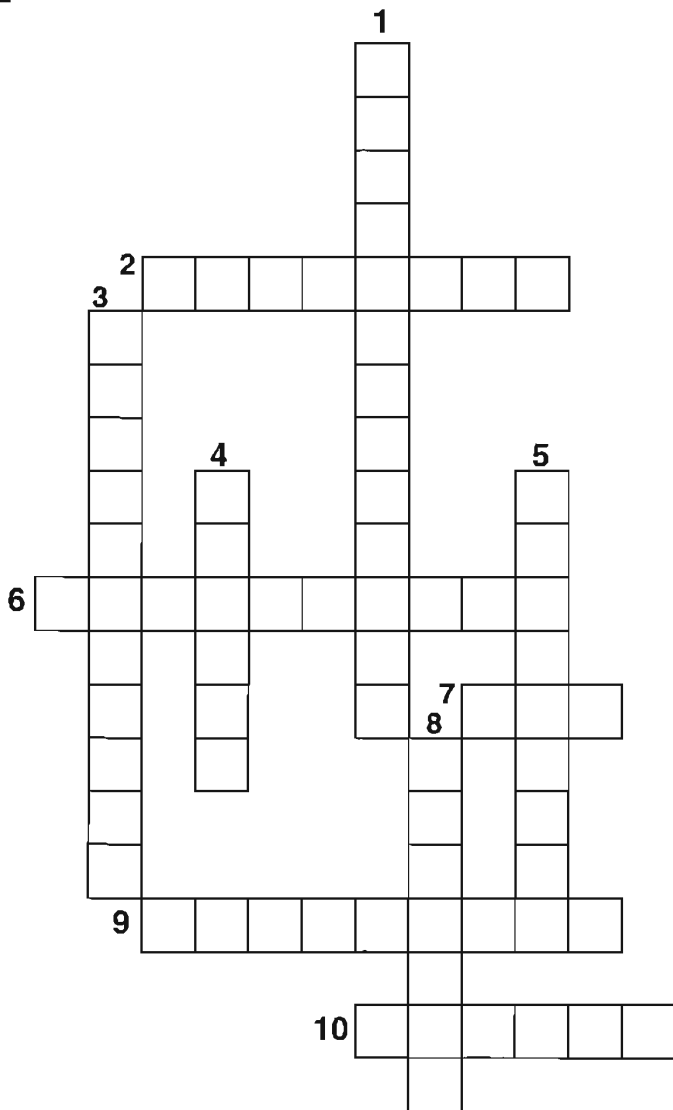

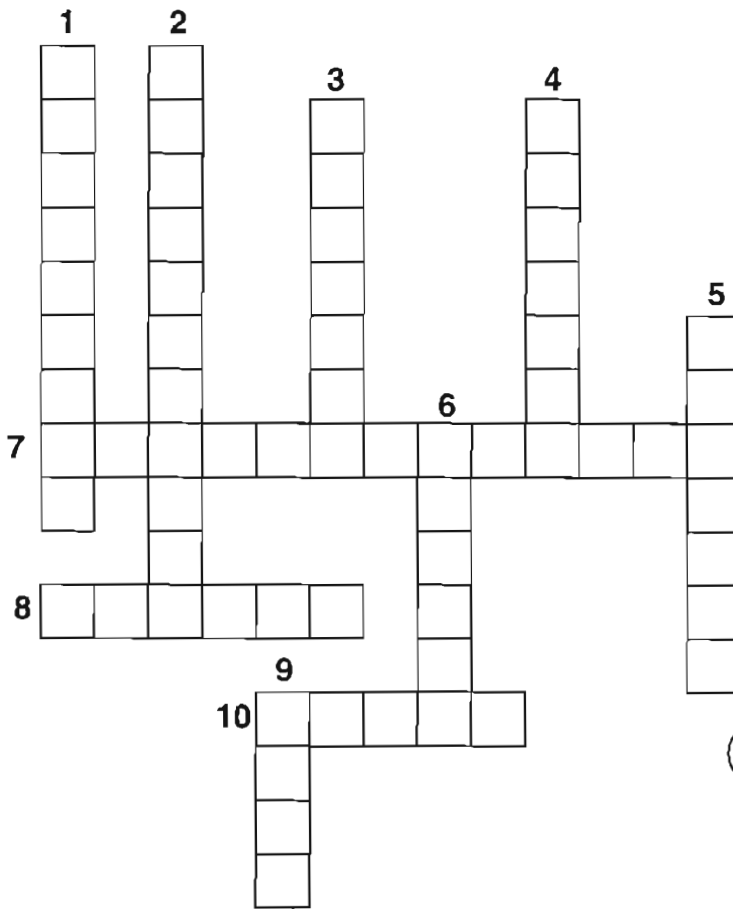
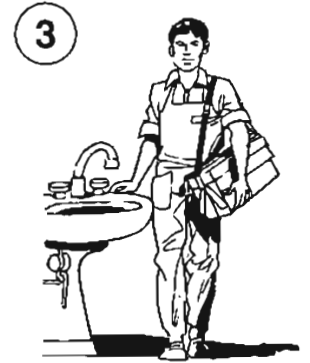

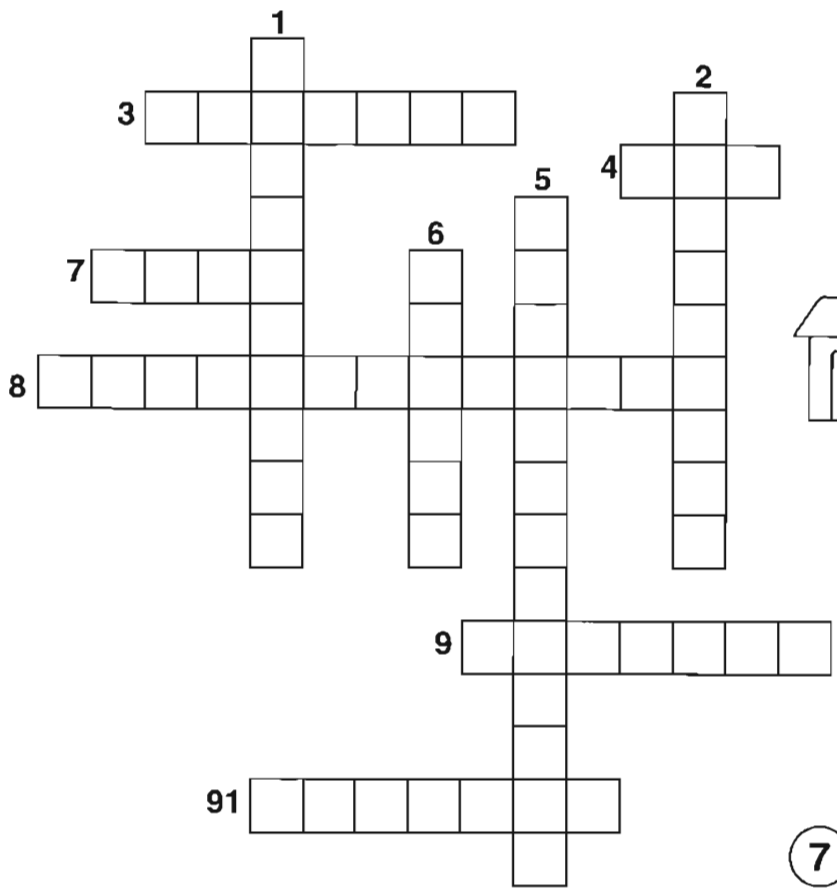

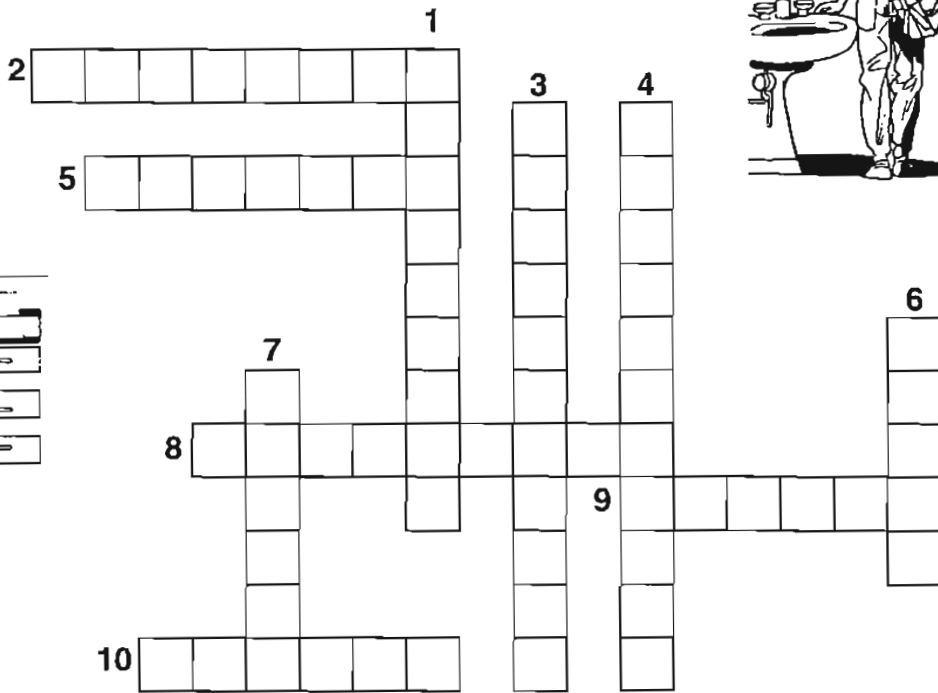
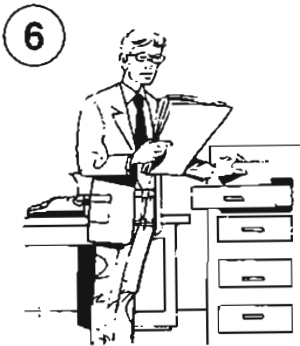
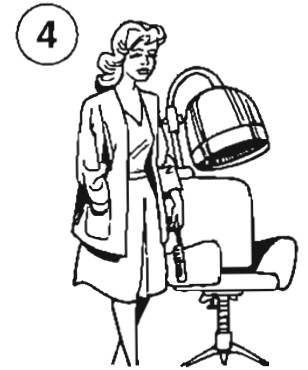

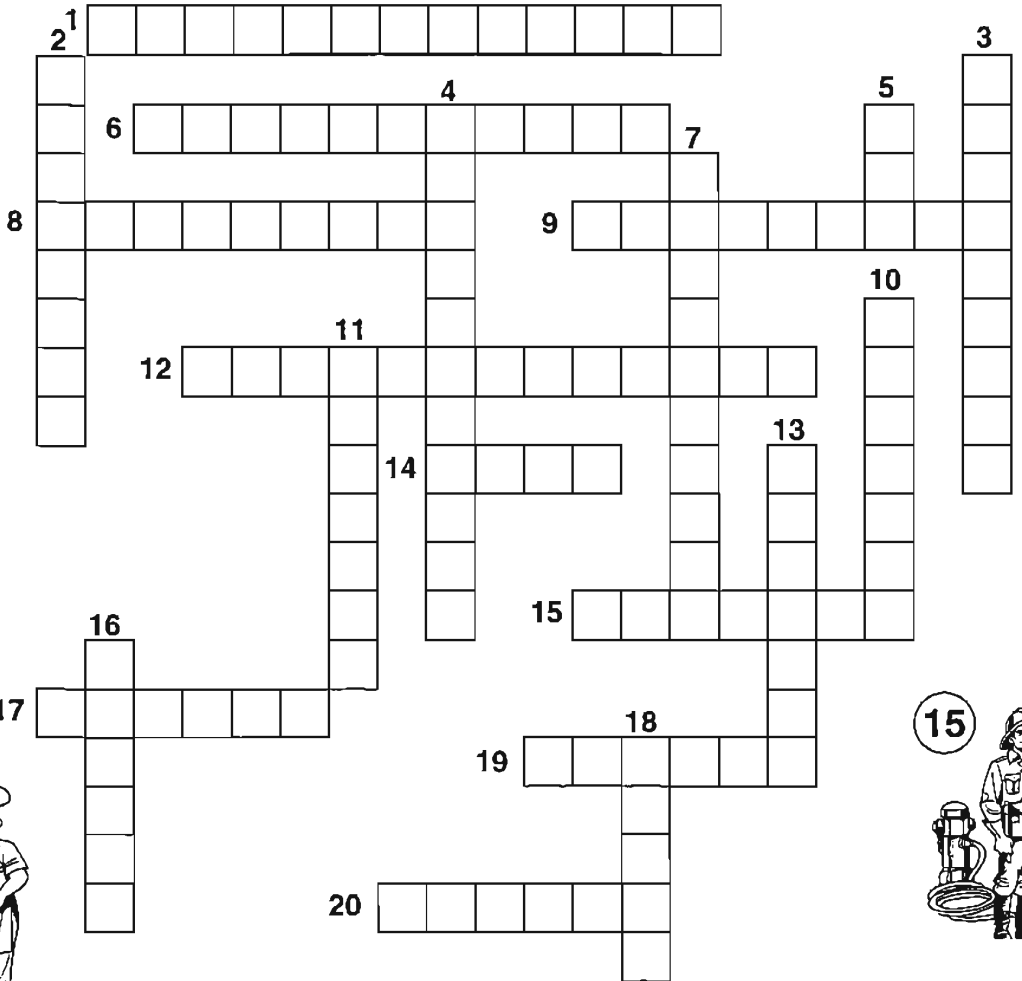
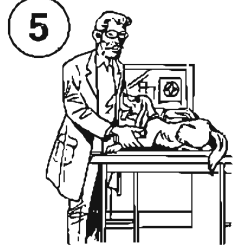



TOOLS



hammer



pincers



nails



saw



screwdriver



spanner

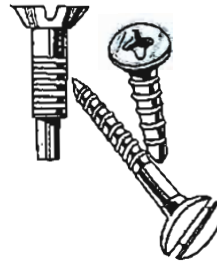

screws



drill



hatchet

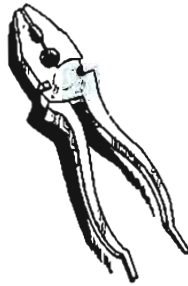

pliers



rasp

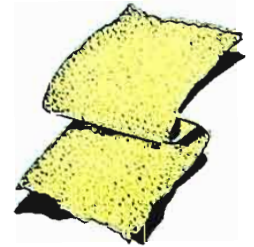

sandpaper



drawing pins

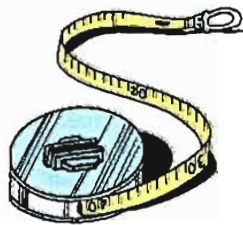

tape measure



shovel

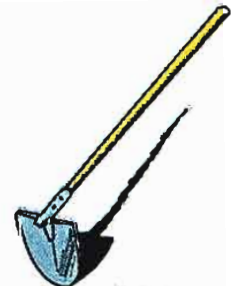

hoe



garden fork



rake



spade



stepladder

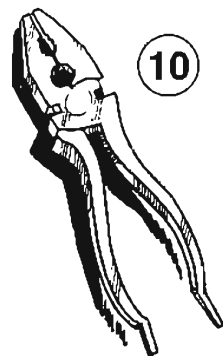
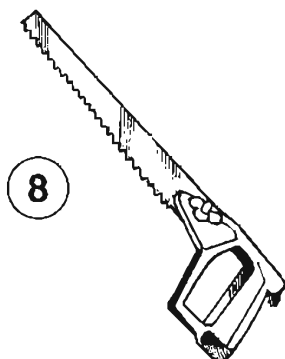
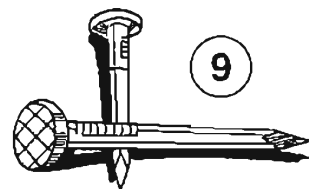
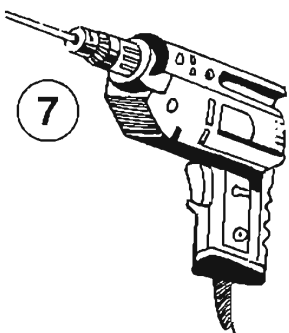
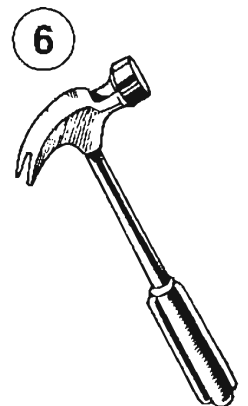
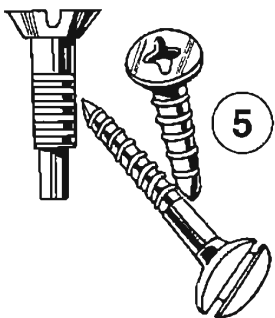
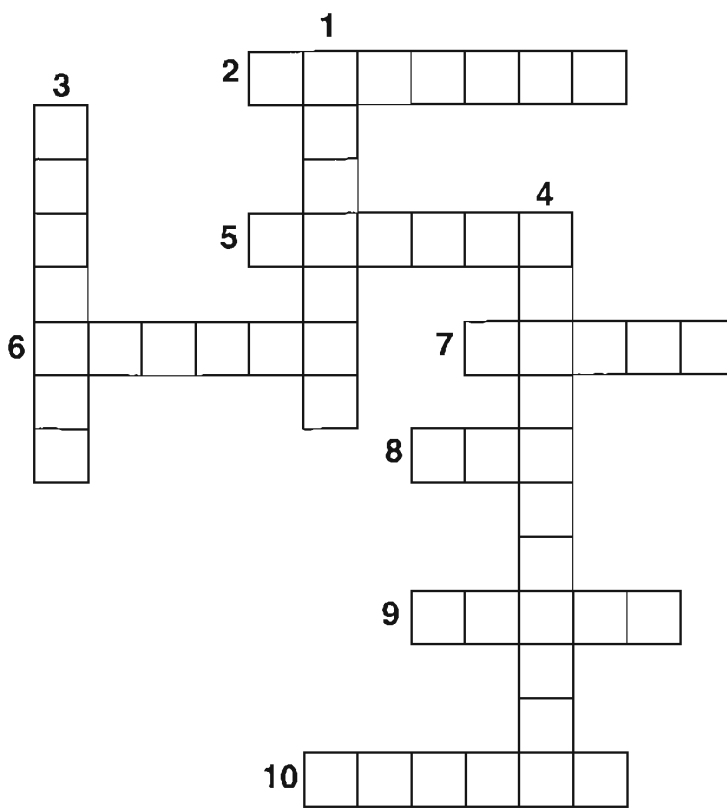
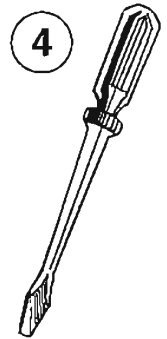
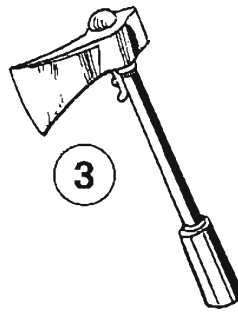
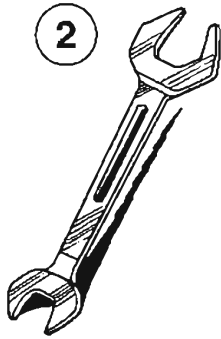
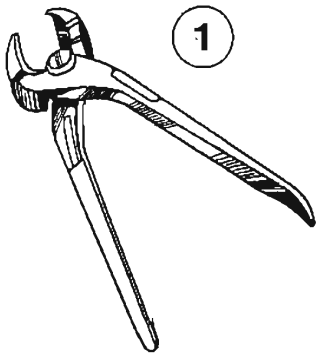

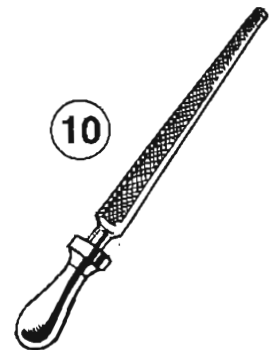
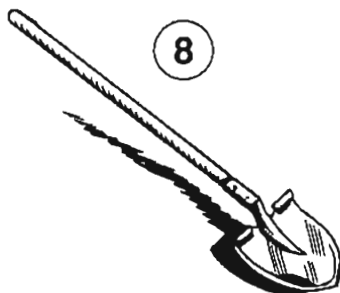
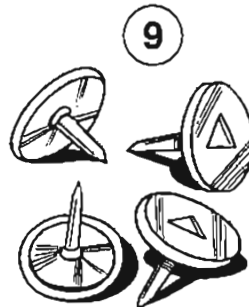
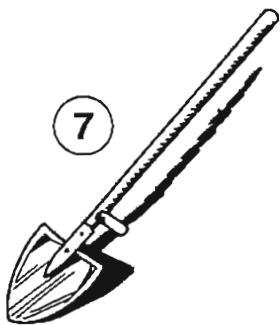
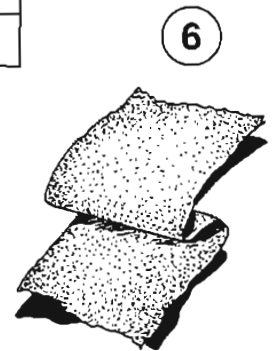
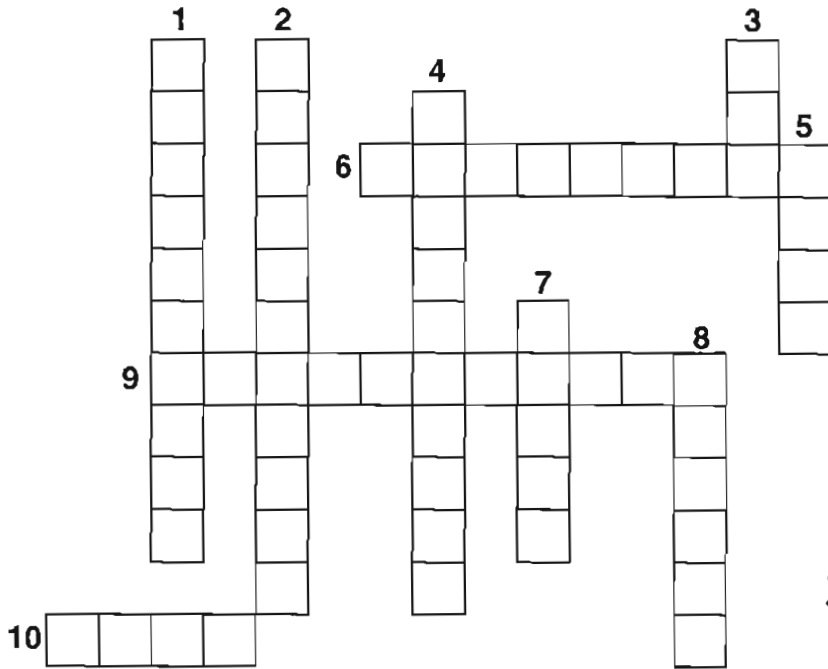
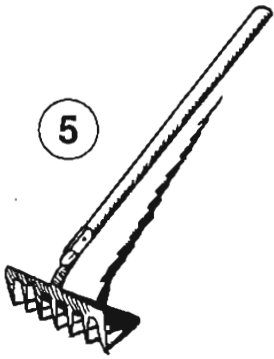
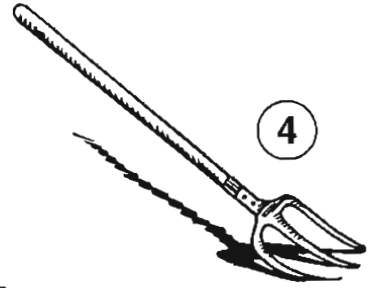
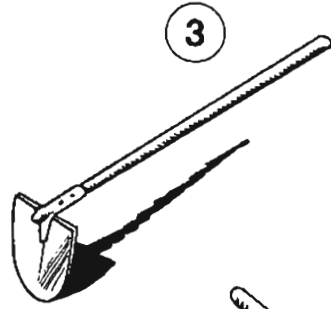
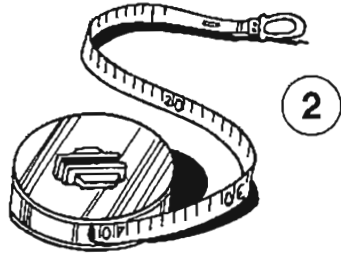

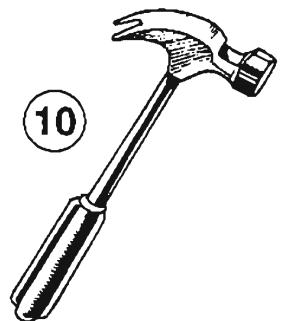
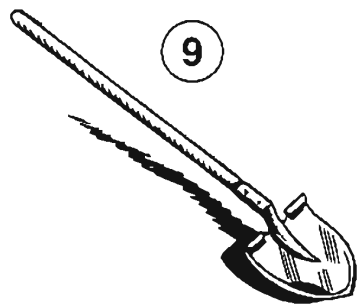
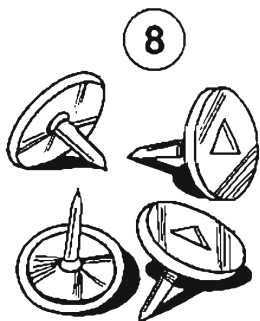
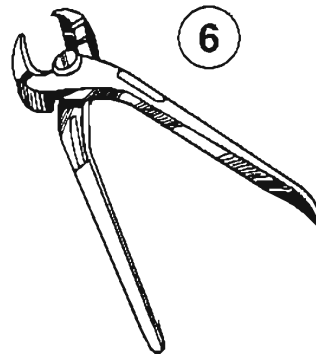
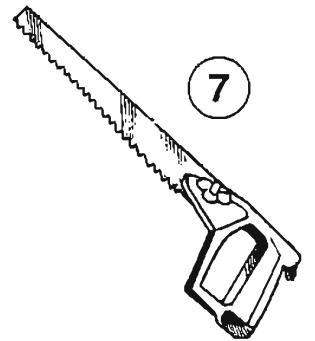
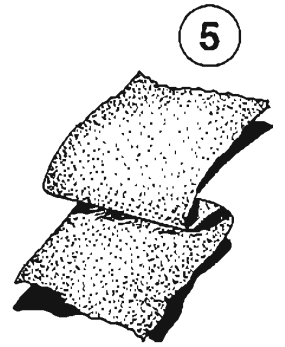
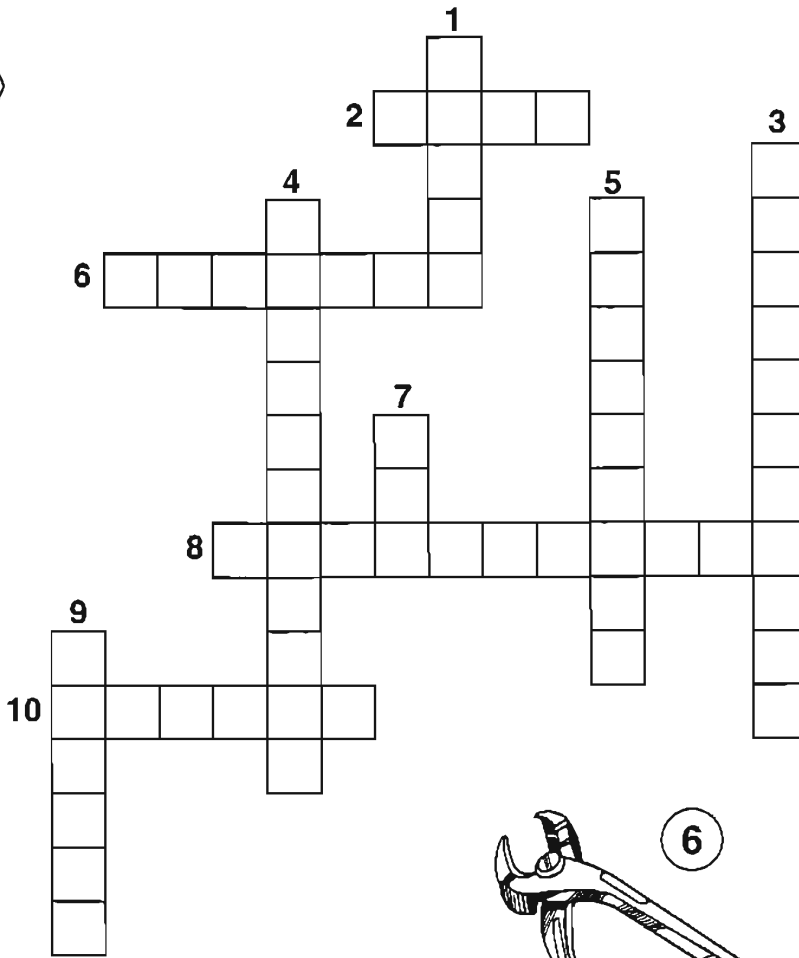
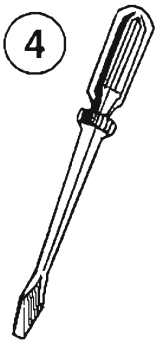
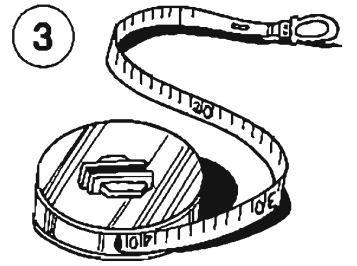
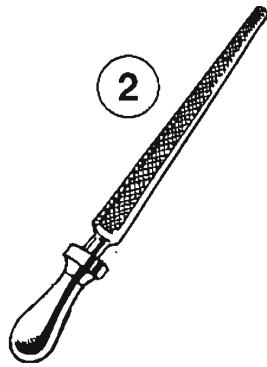
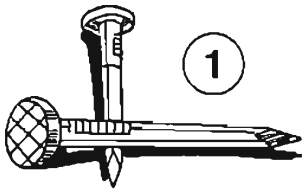

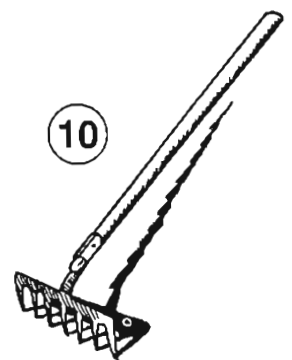
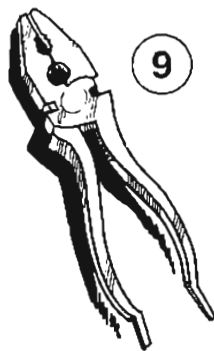
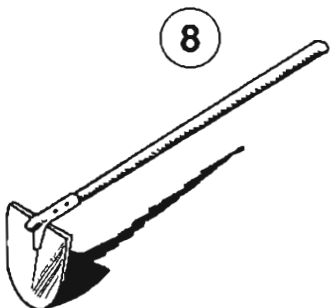
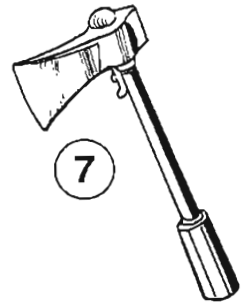
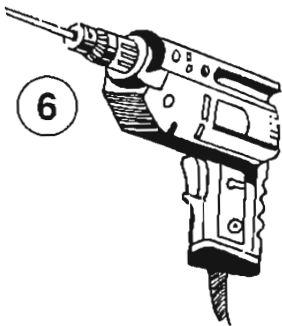
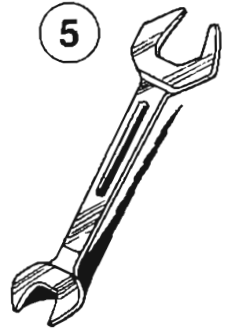
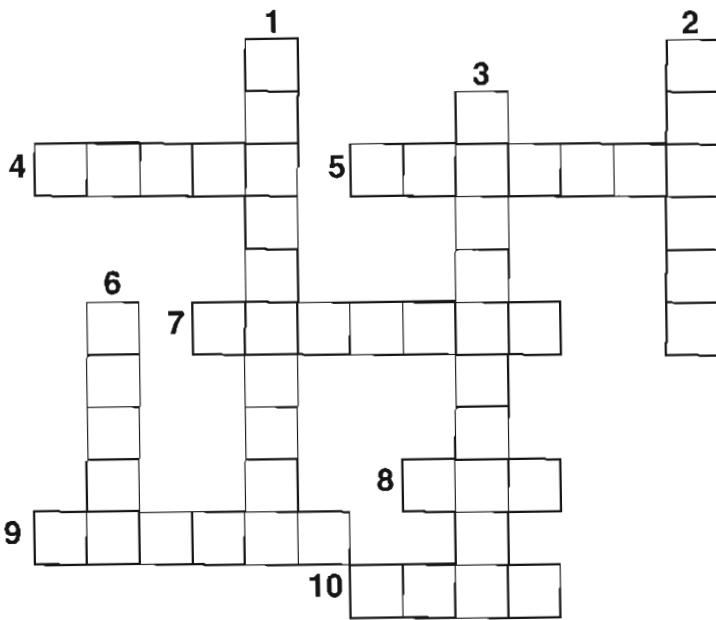
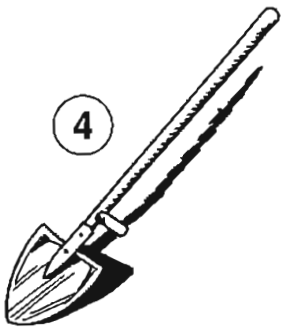
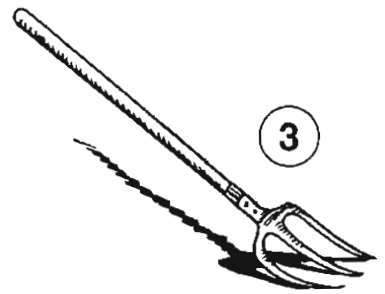
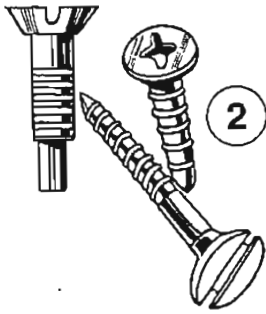

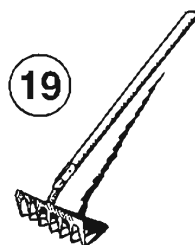
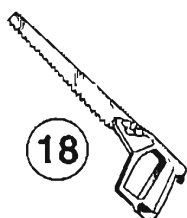
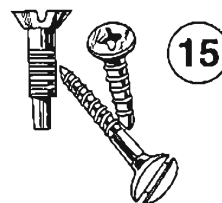
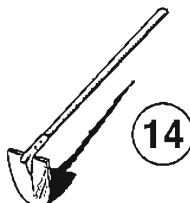
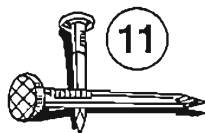
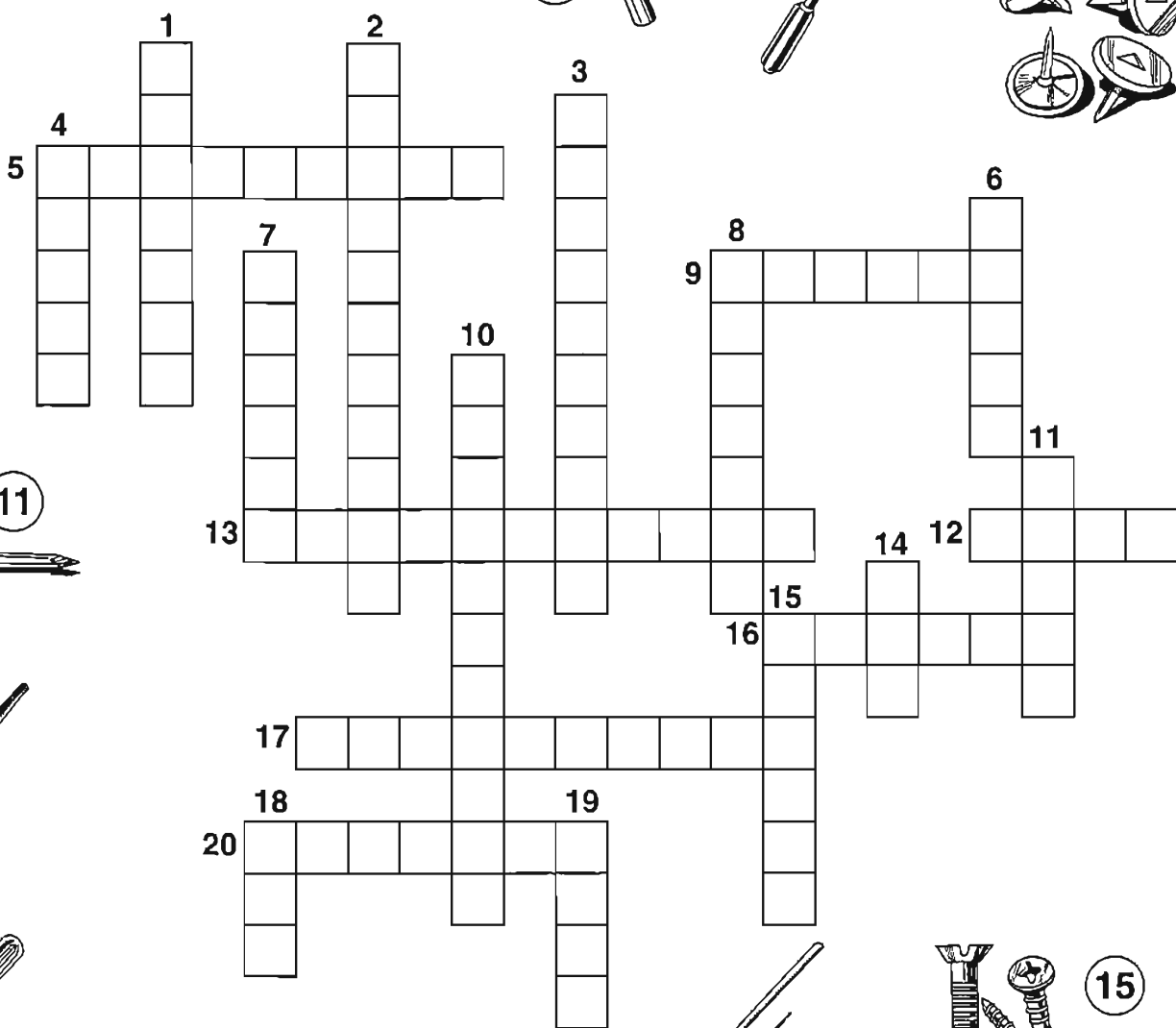
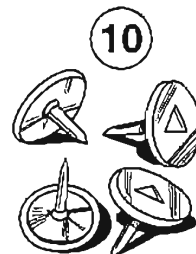
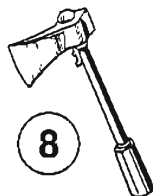
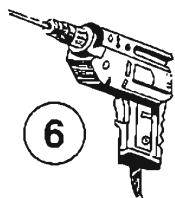
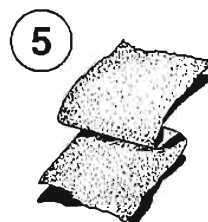
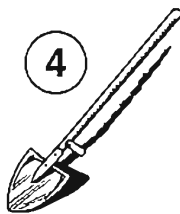
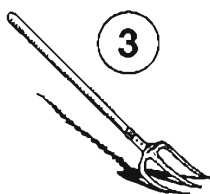
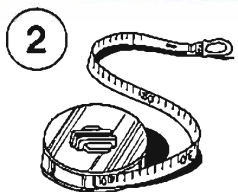
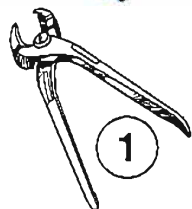



IN THE KITCHEN



glass

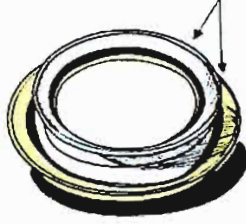

dishes



knife



fork



spoon



teaspoon



cup



saucer



bottle

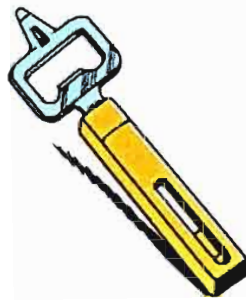

bottle opener



tin opener



saucepans



lid



teapot



kettle



frying pan



blender



tin



bowl



matches

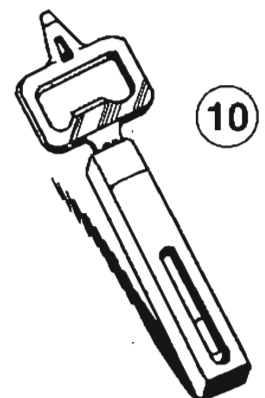
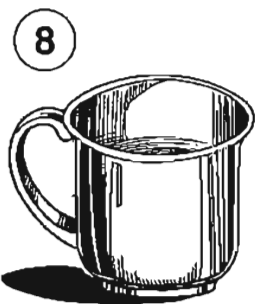
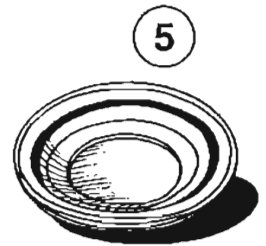
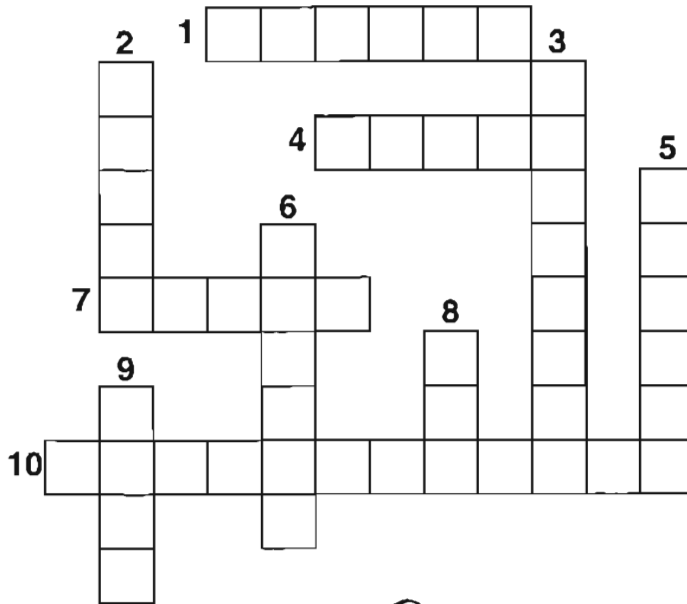
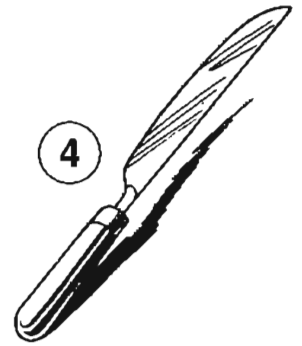
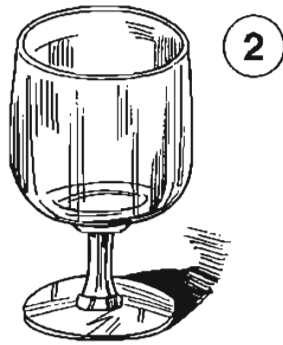
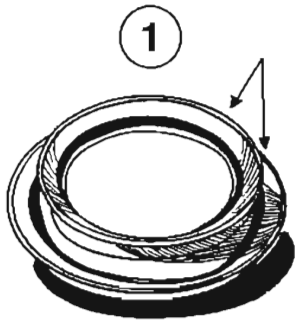
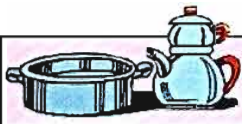

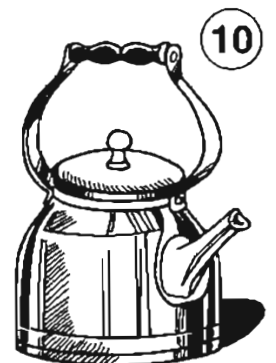
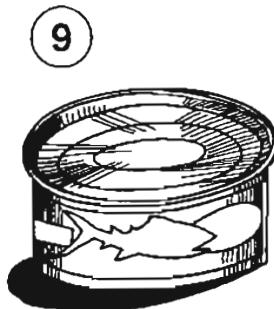
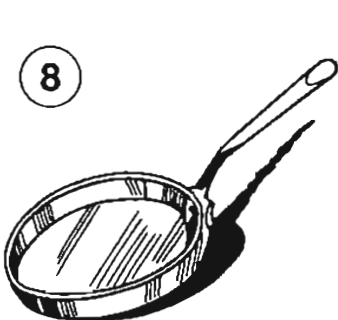
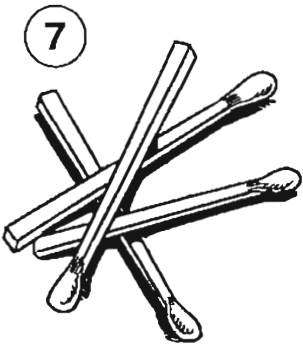
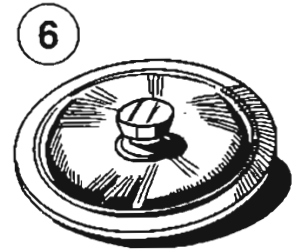
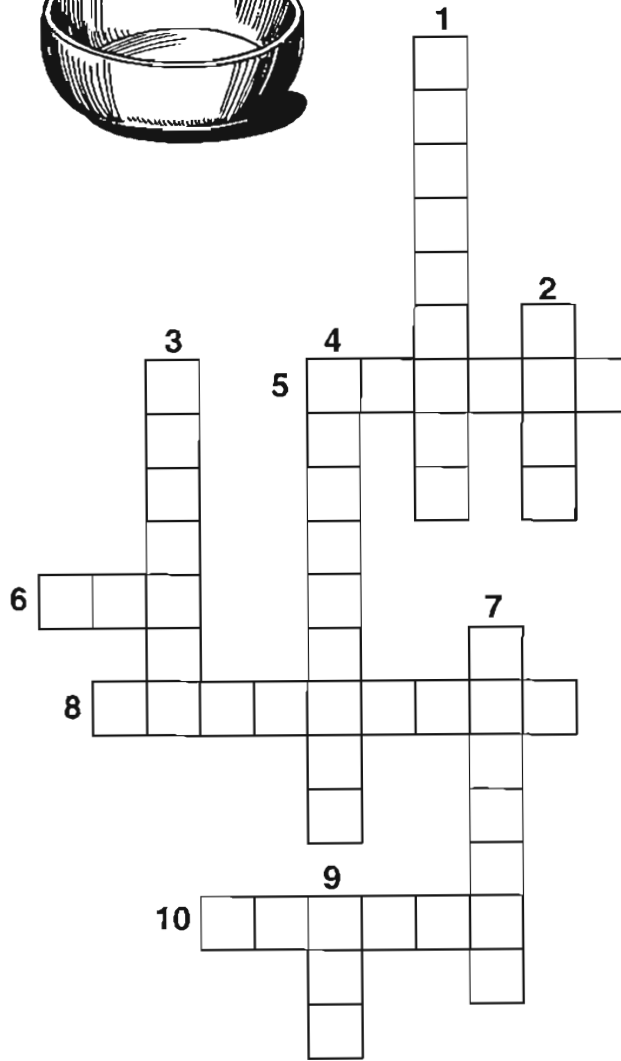
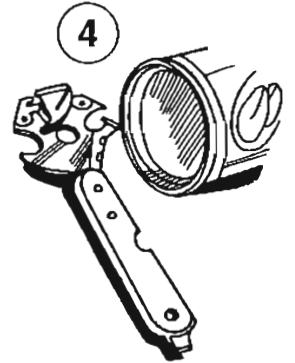
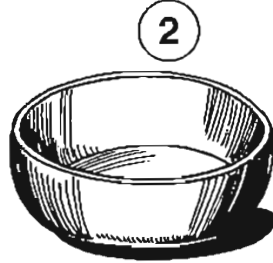
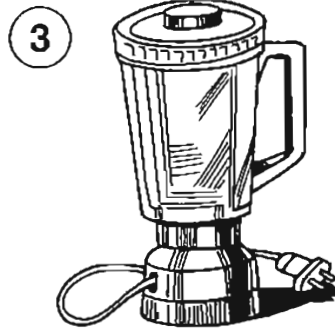
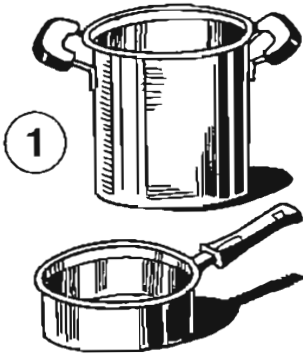

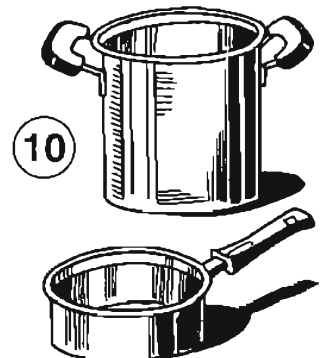
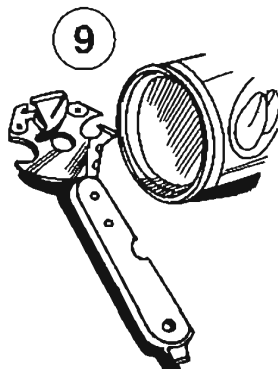
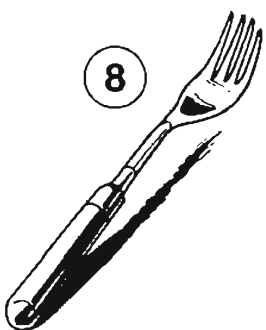
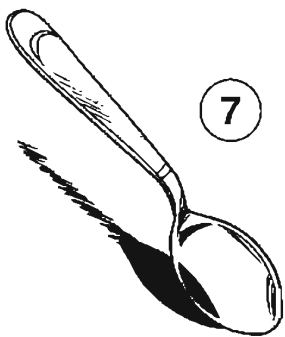
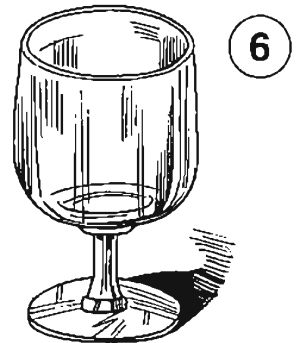
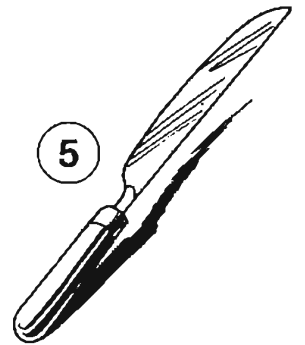
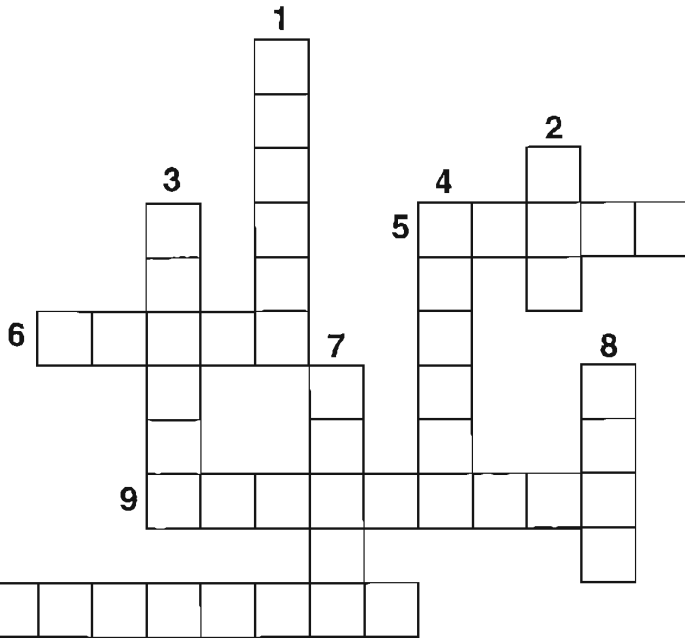
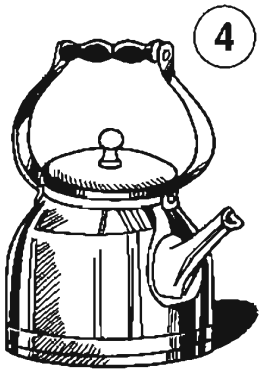
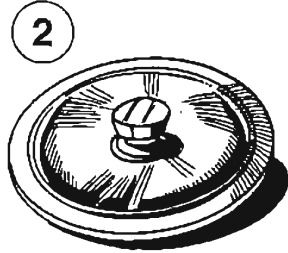
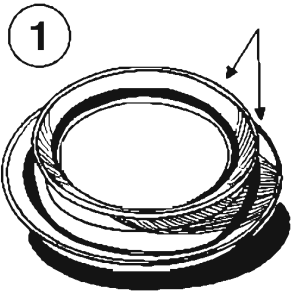
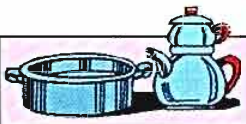

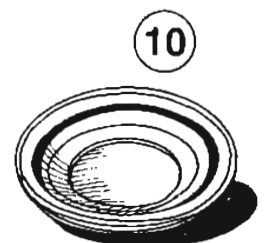
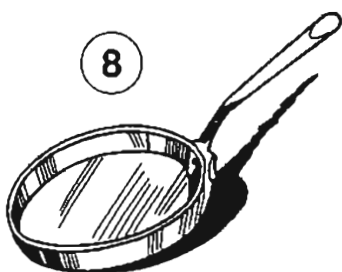
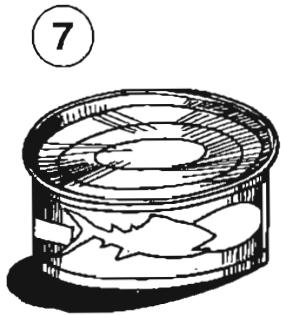
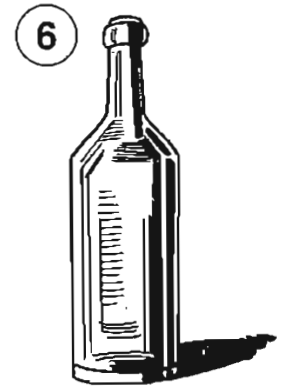
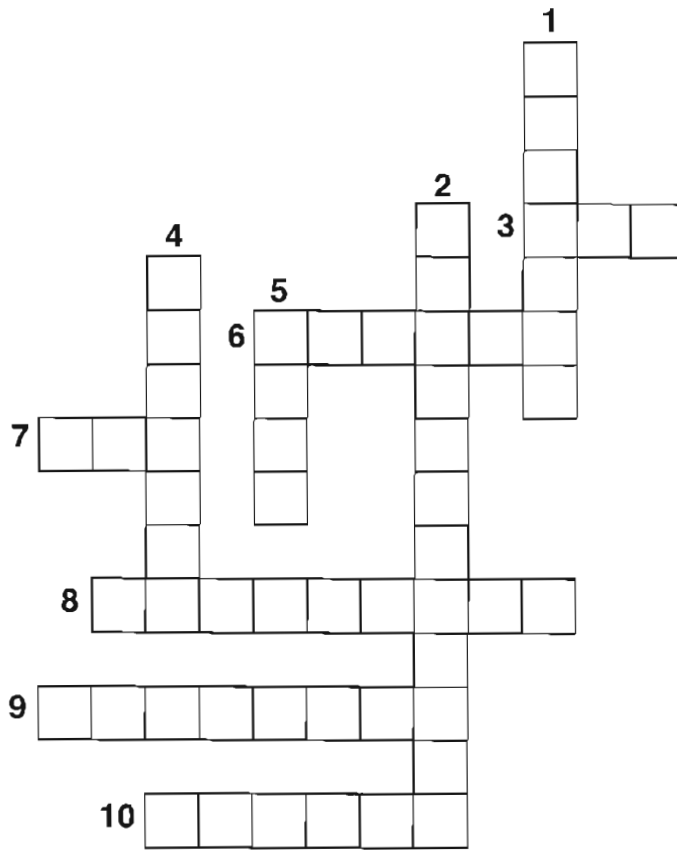
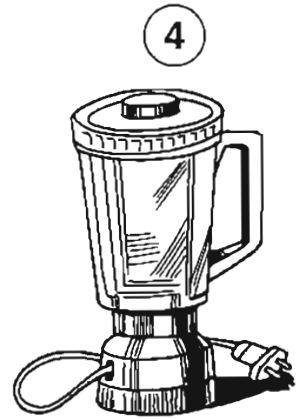
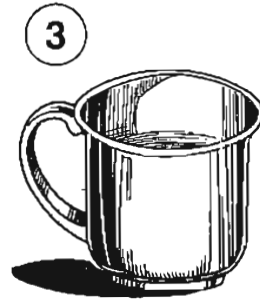
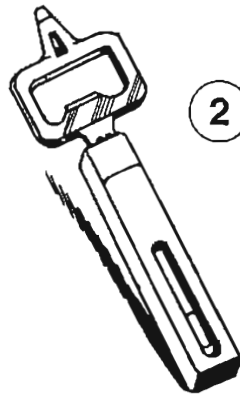
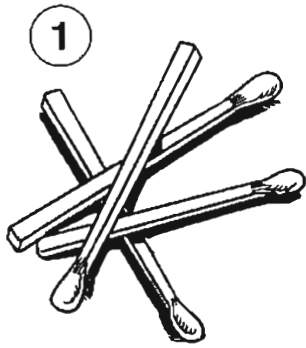

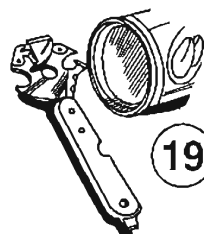
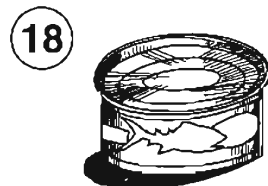
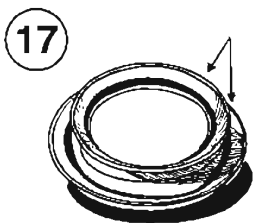
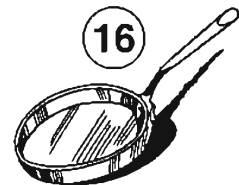
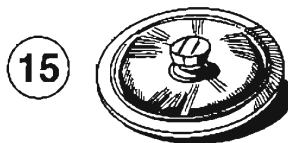
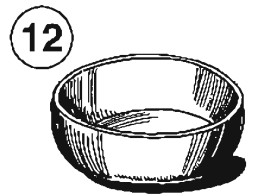
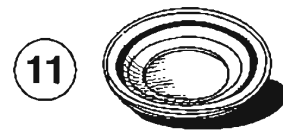
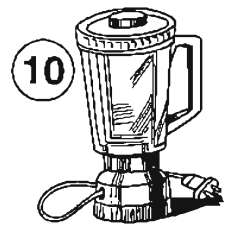
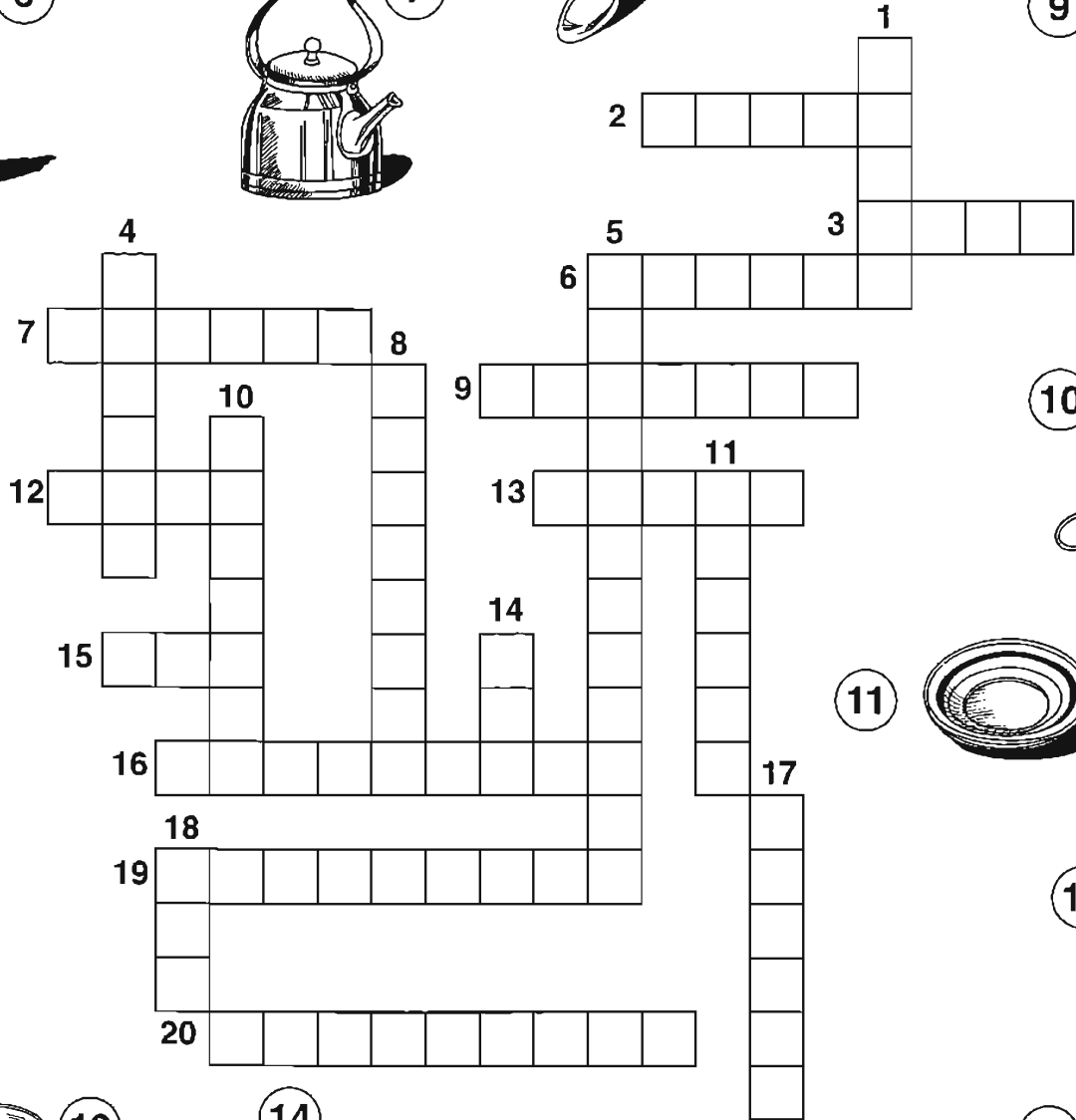
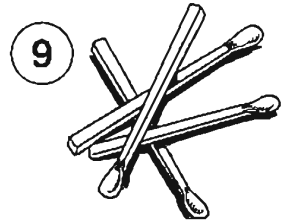
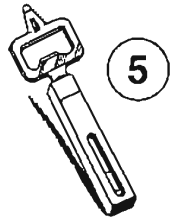
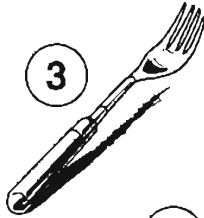
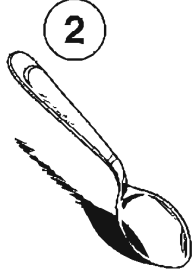
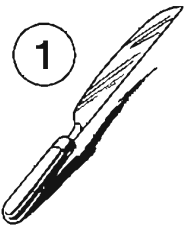



BIRDS



pigeon



sparrow



robin



swallow



seagull



pelican



owl



eagle



canary



dove



parrot



blackbird



stork



swan



woodpecker



crow



flamingo



magpie



peacock



falcon

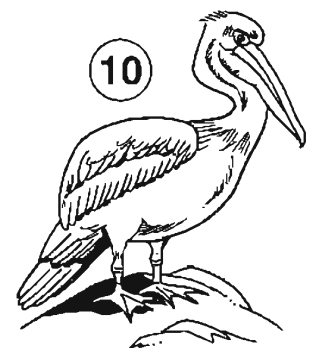
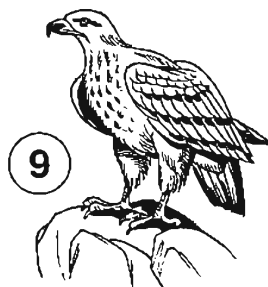
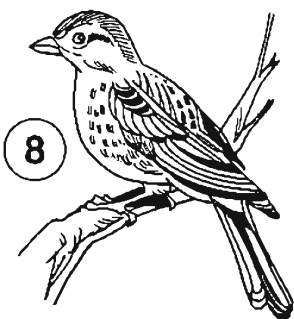
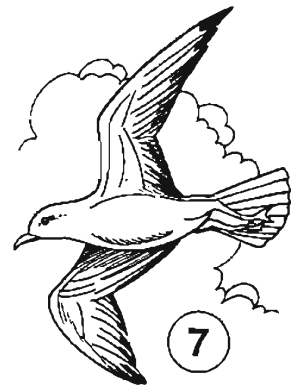
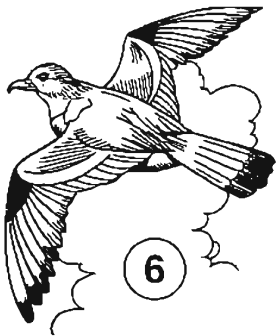
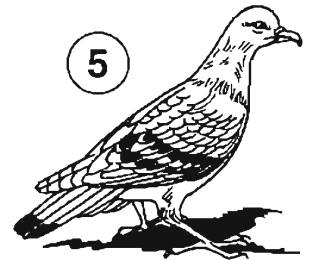
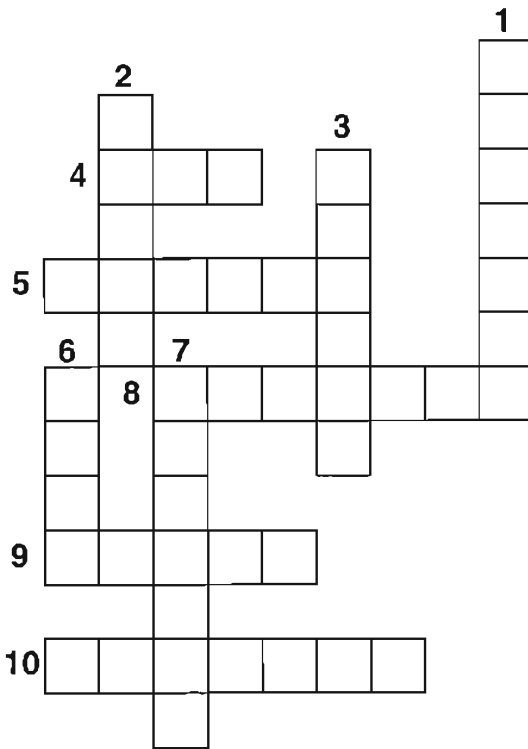
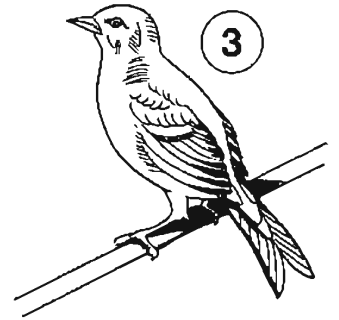
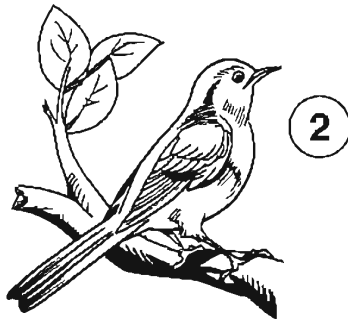

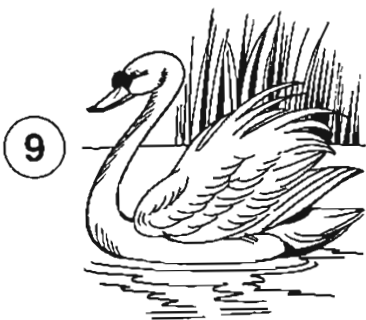
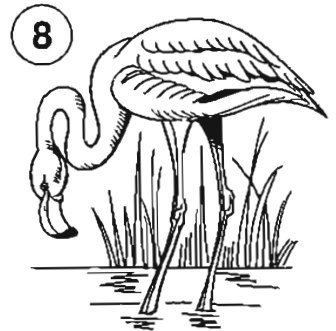
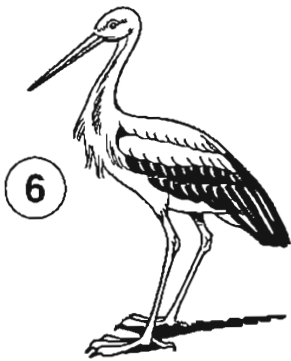
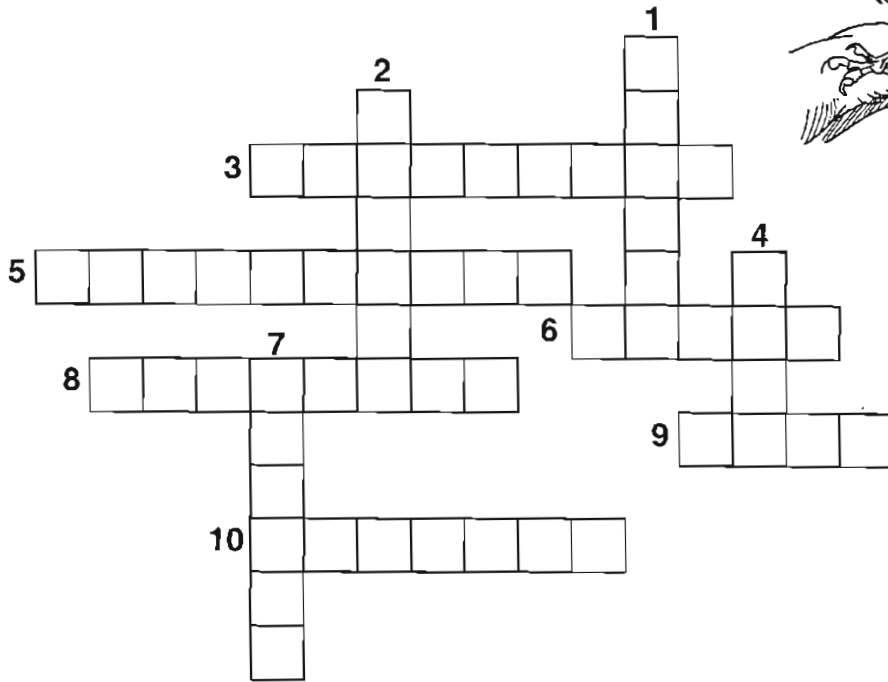
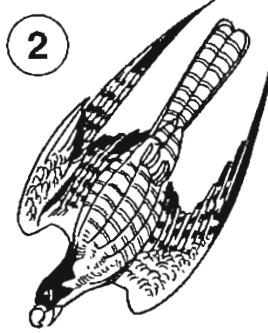

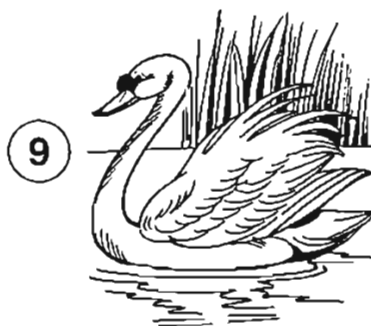
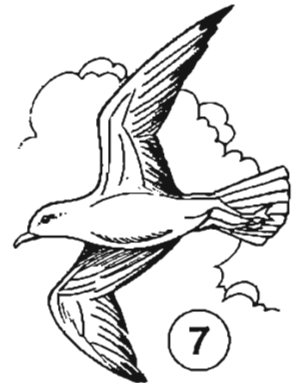
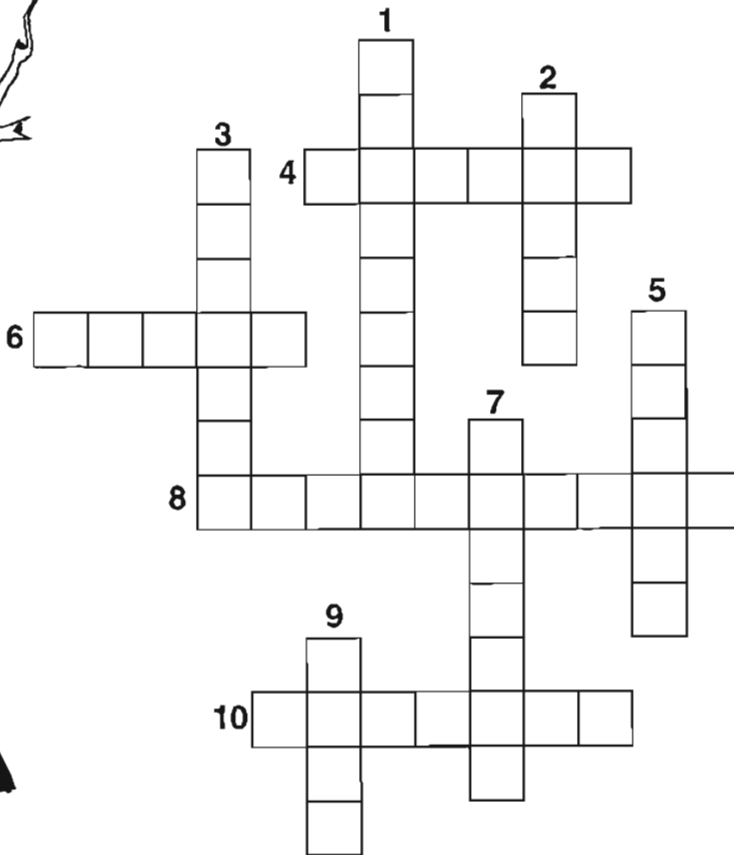
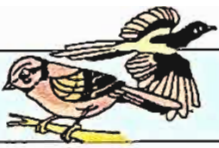

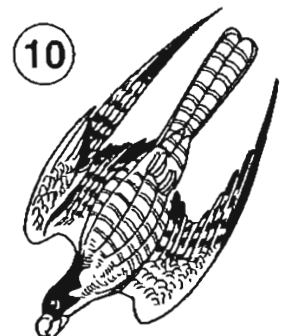
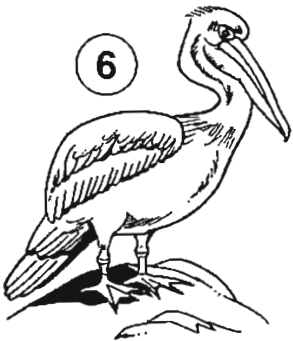
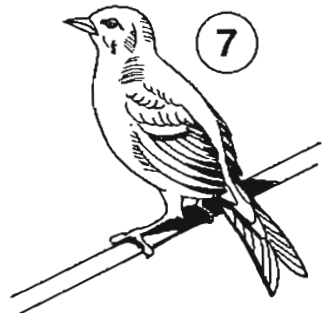
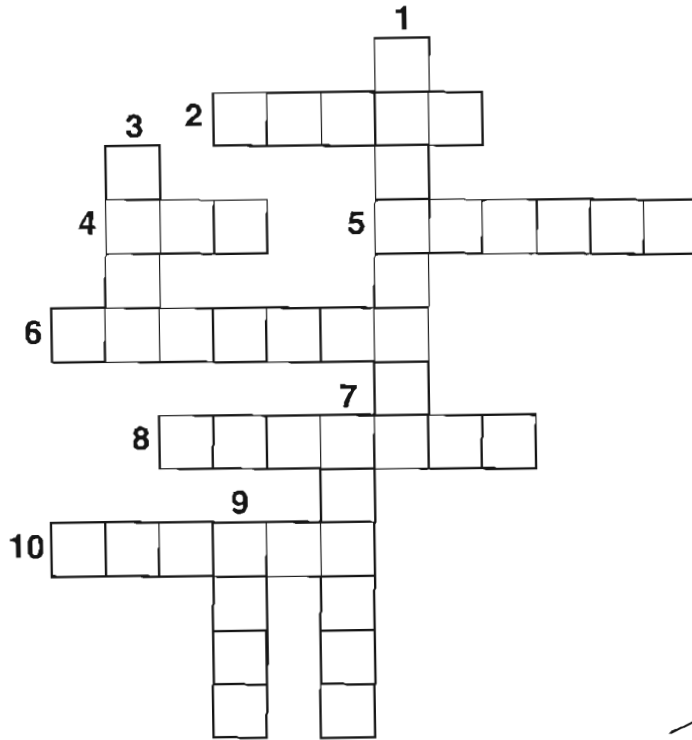
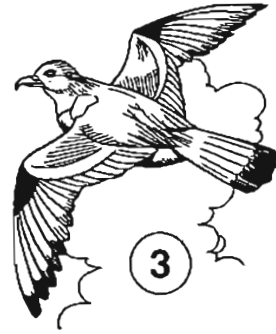
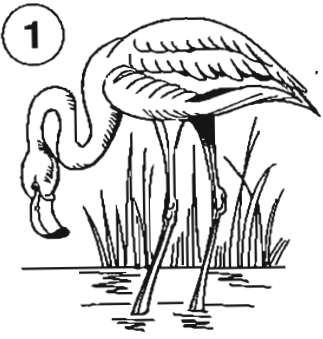
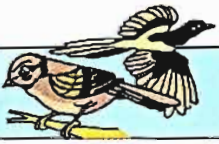

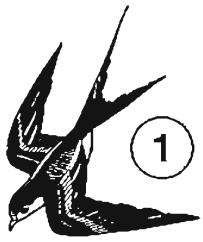
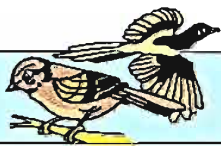

2

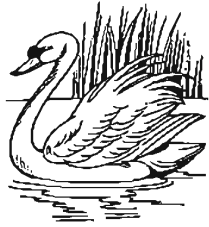

3



4



5

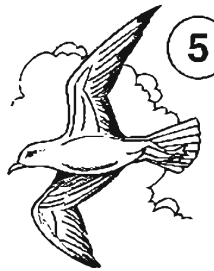

7



8



9

10



11

11



19

15



12



13

14



16



17

18



19

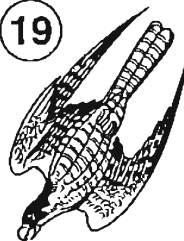

20

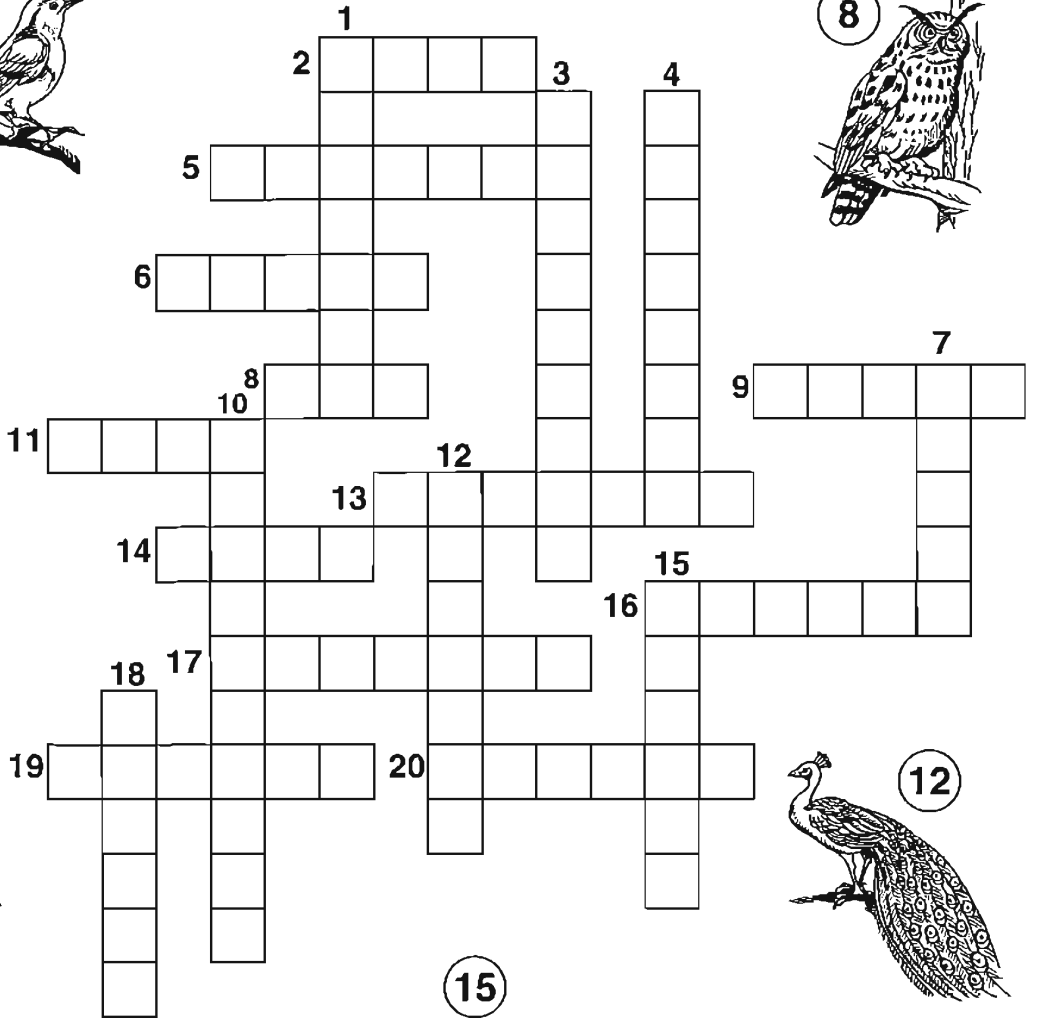



AT THE AIRPORT



airport

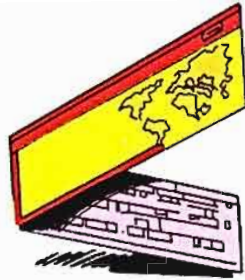

ticket



customs

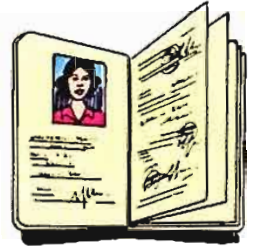

passport

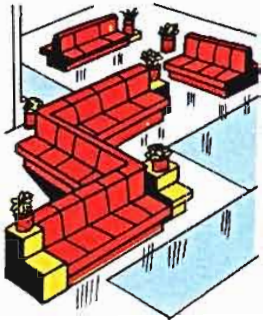

passenger lounge



passengers



control tower

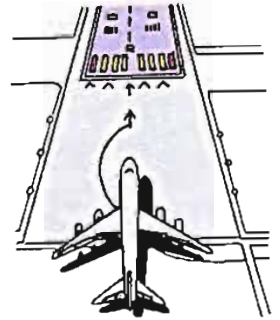

runway



plane



wings



steps

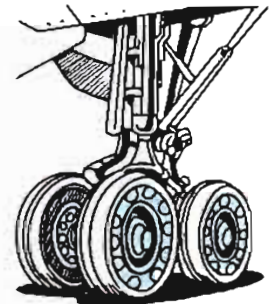

landing gear



cockpit



seat



seat belt



pilot



aisle



stewardess



steward



luggage



1

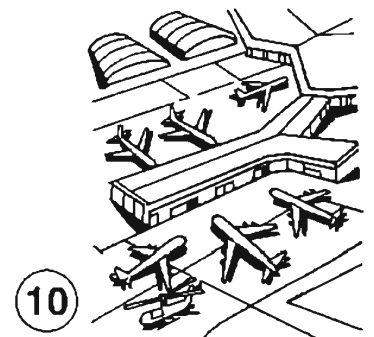
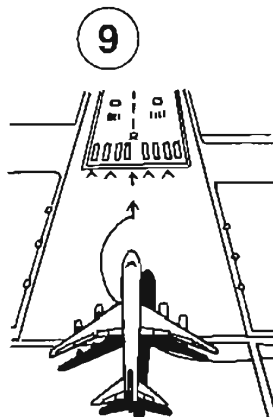
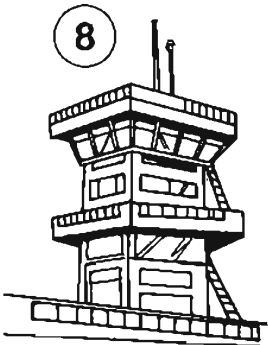
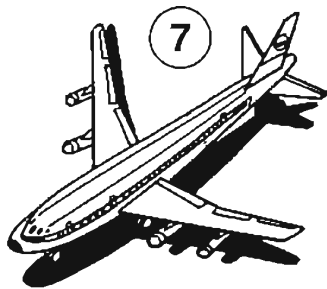
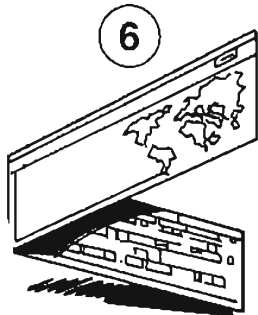
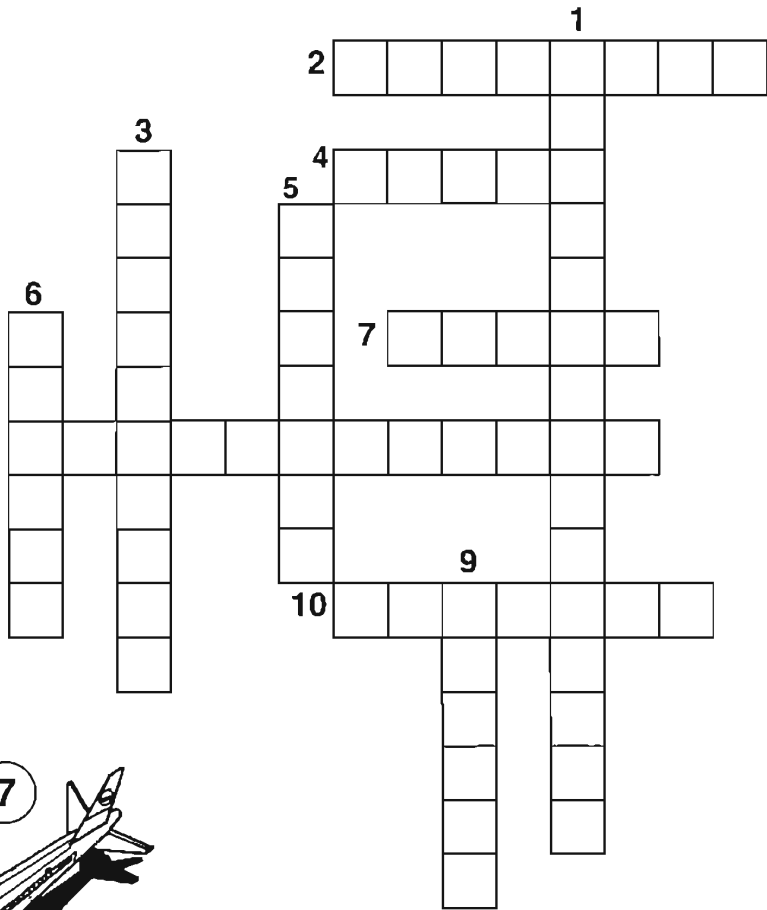
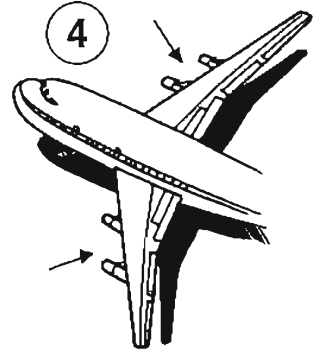
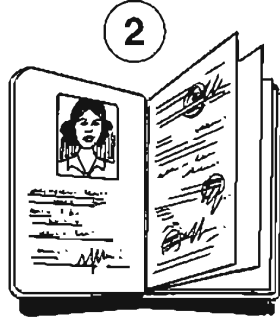
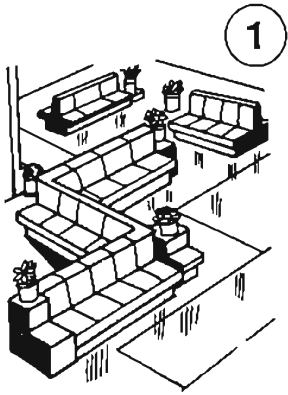

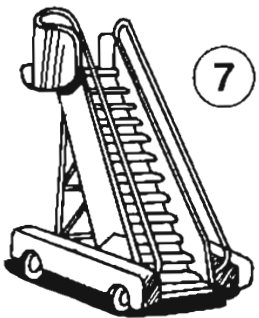
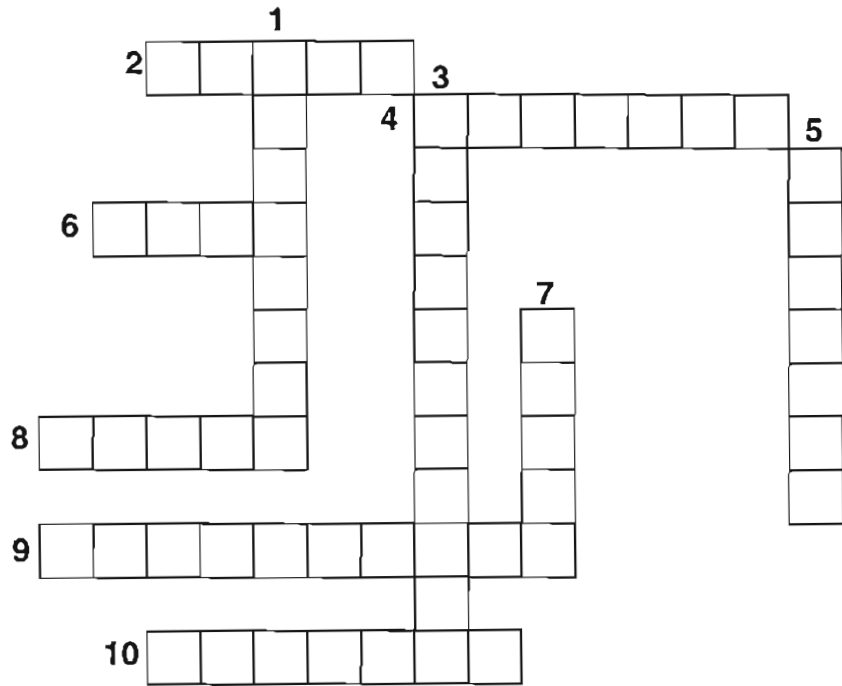
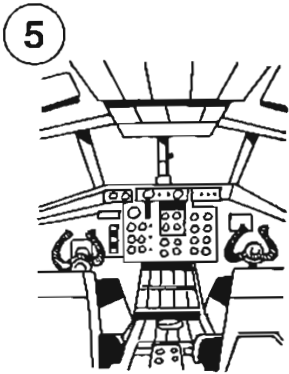
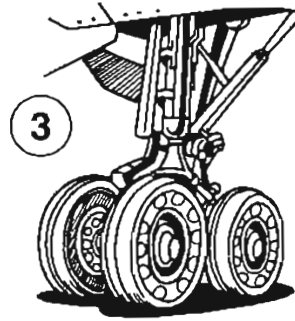

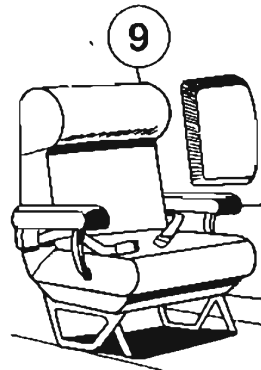
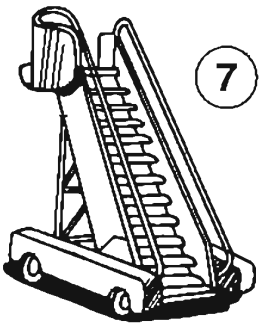
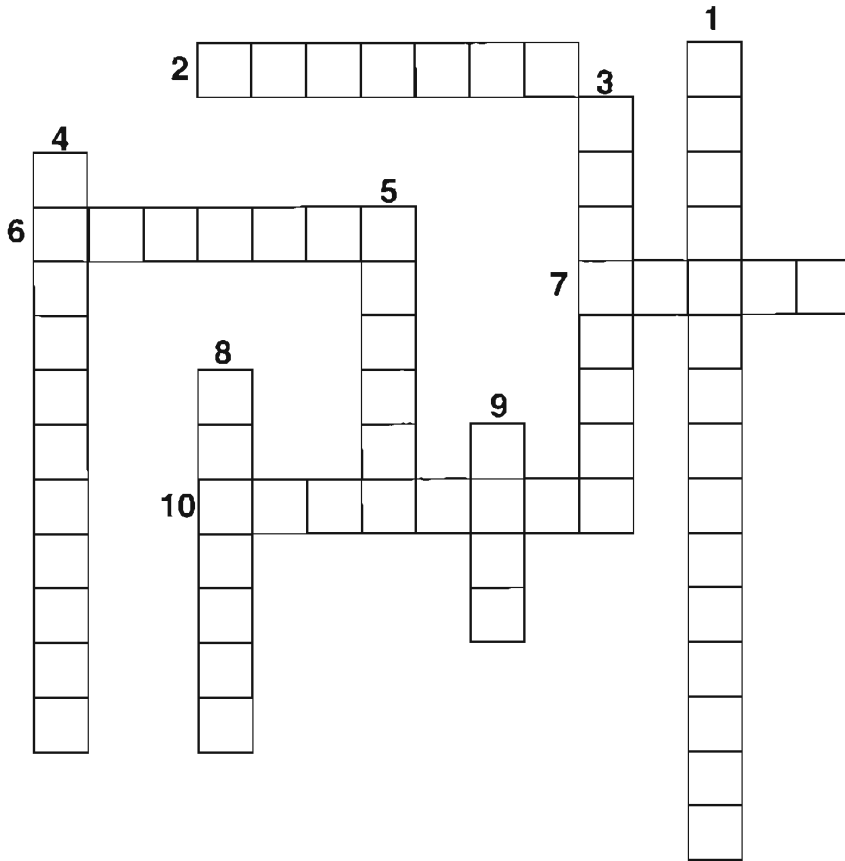
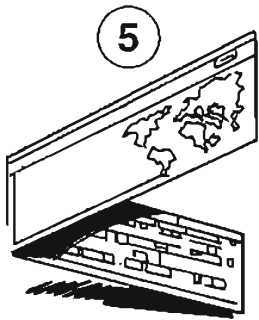
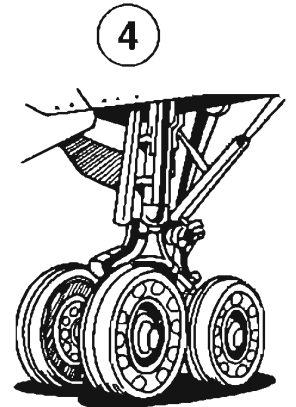
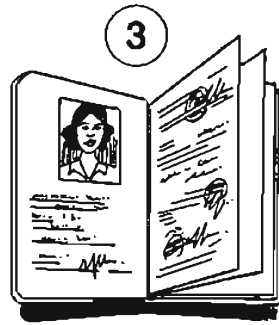
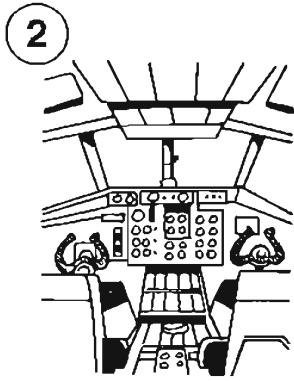
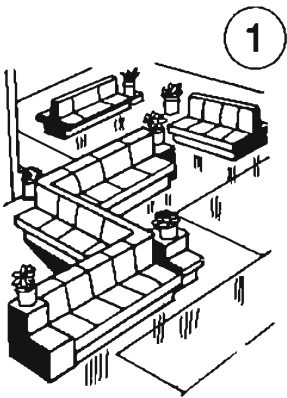



1



2



3



4

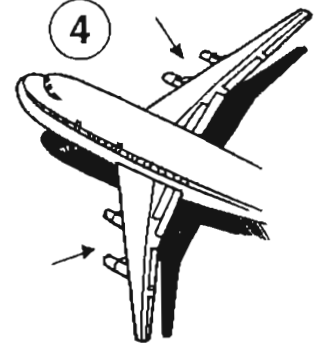

5

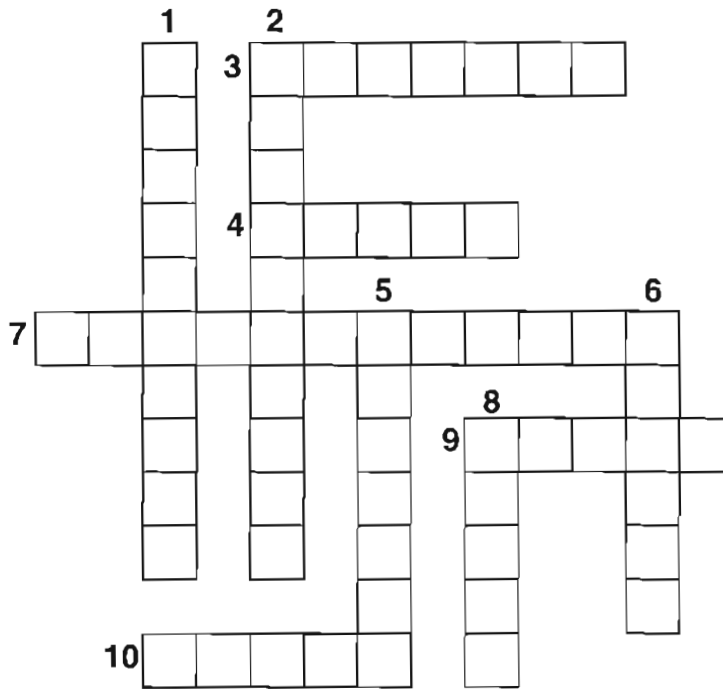

6

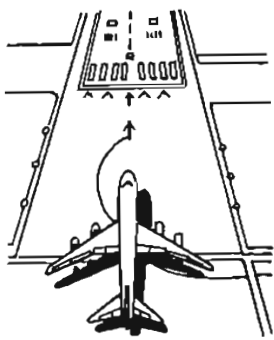

7



8



9

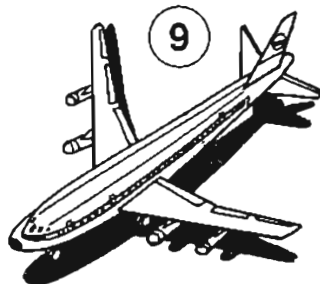

10

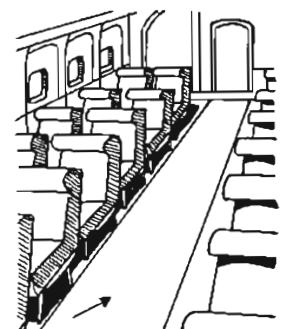

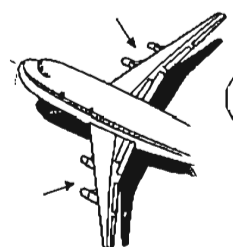
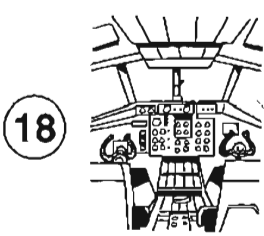
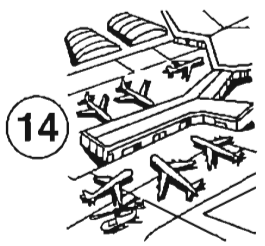
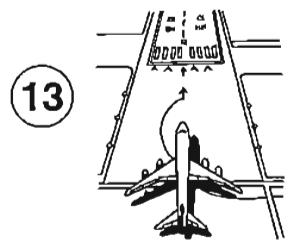
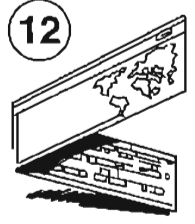
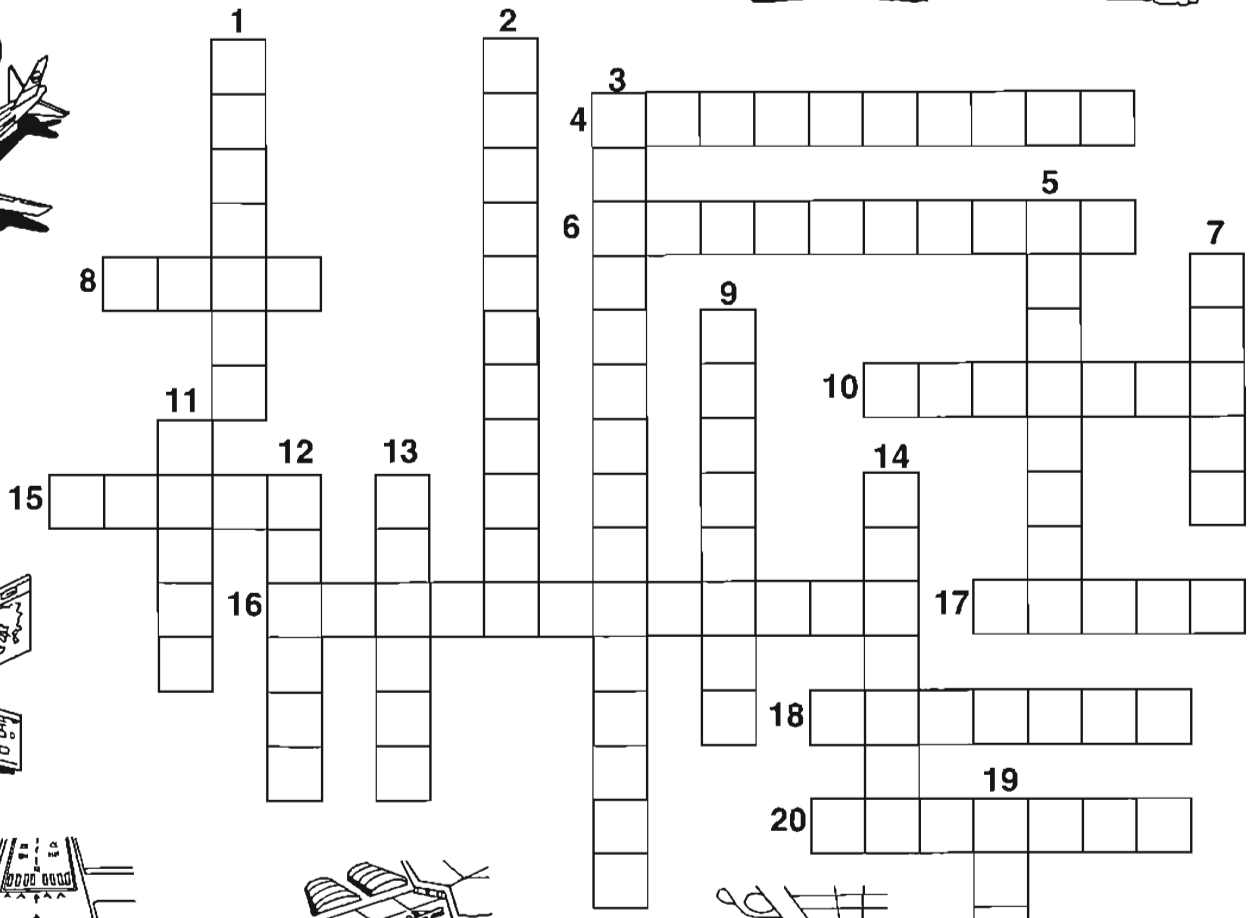
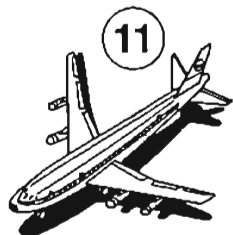
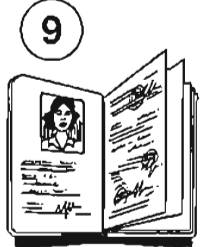
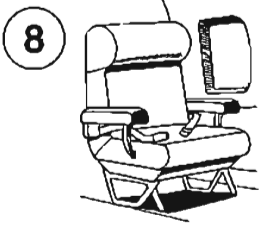
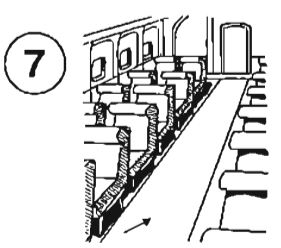
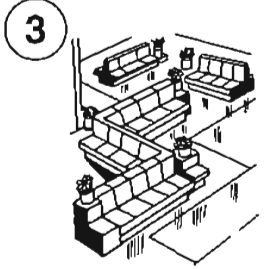
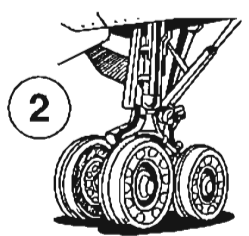
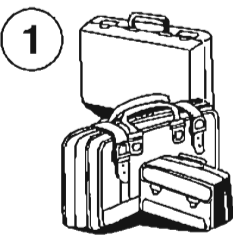



FLOWERS



daisy



rose



iris



narcissus



orchid



tulip



sunflower



cyclamen



carnation



poppy



pansy



violet



lily of the valley



mimosa



daffodil



lily



hyacinth



anemone



gladiolus



forget-me-not

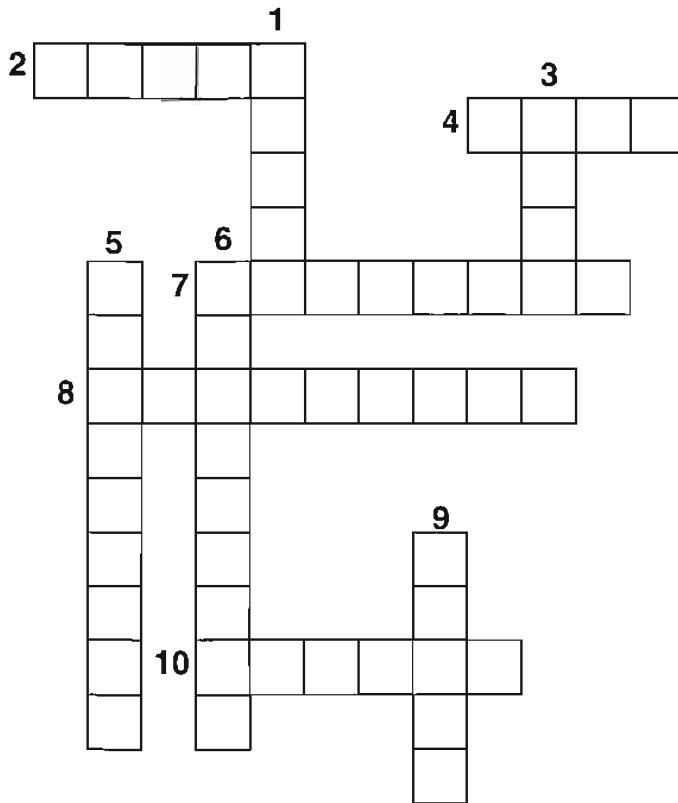

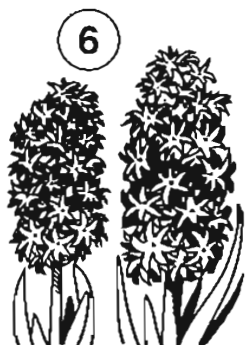
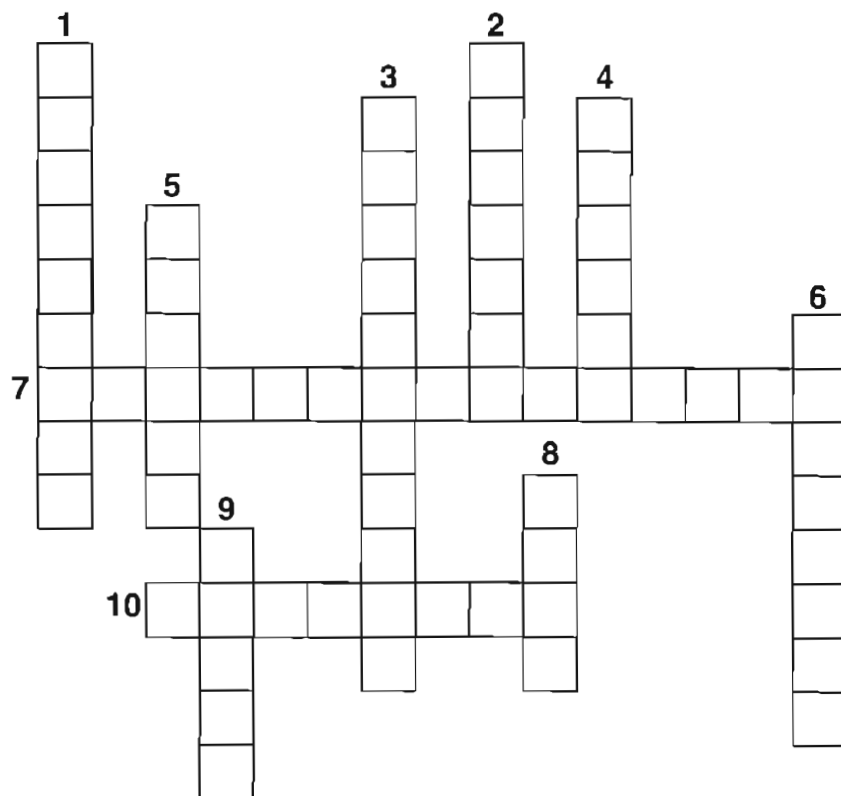

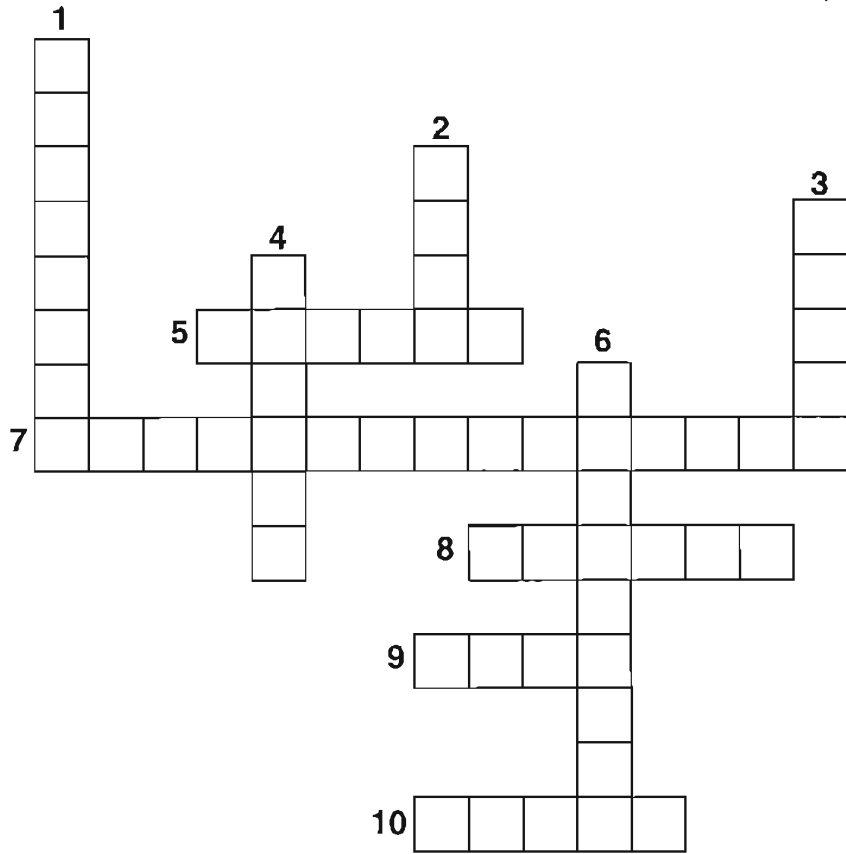
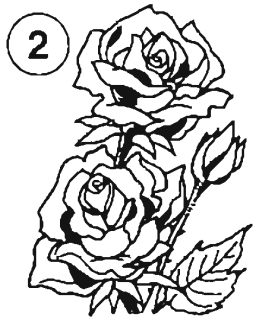

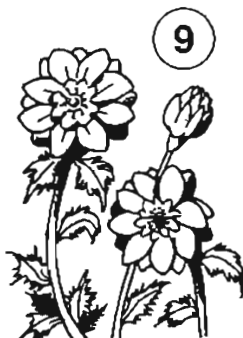
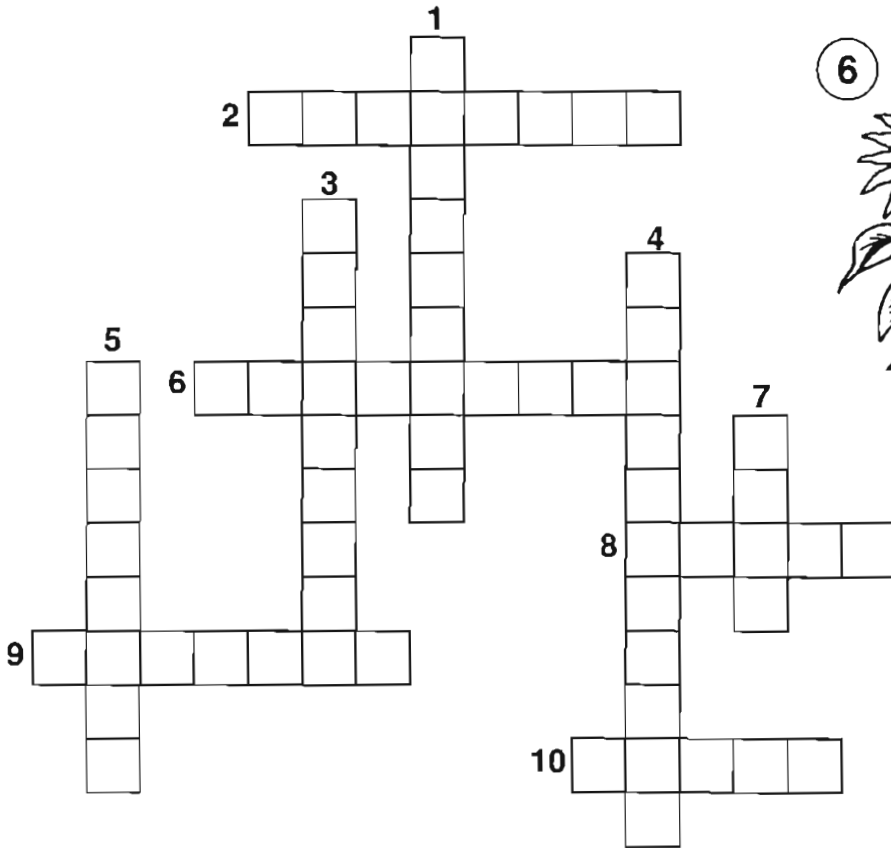



1



2



3



4



5



6



7



8

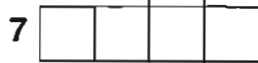
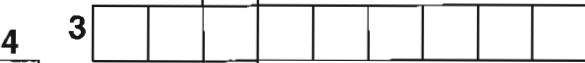
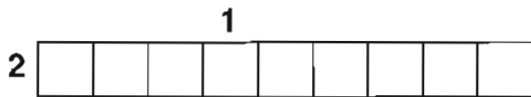

9



10

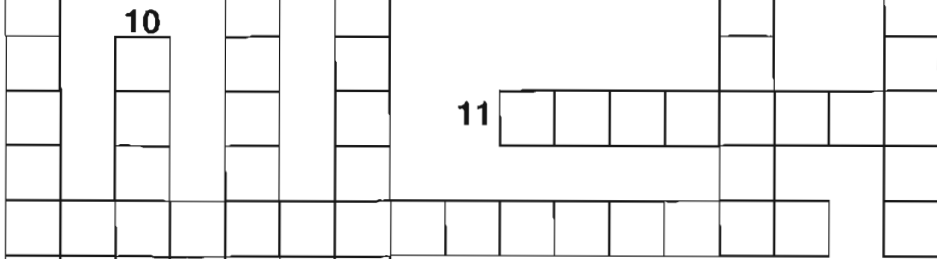

11



12



13

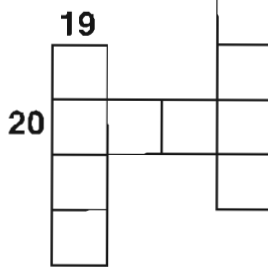
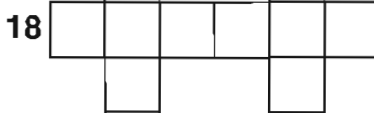
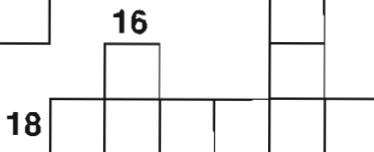

14



15



16



17



18



19



20





MUSICAL INSTRUMENTS



flute



clarinet



violin



cello



double bass



French horn



piano



trumpet



trombone



saxophone



drums



drum



guitar

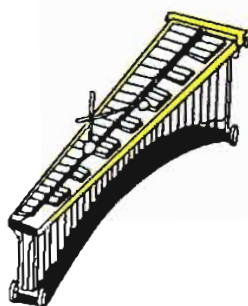

xylophone



accordion

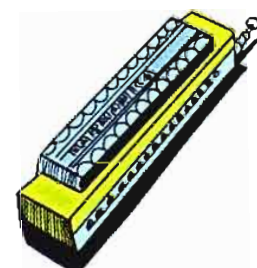

harmonica



cymbals



banjo



harp



electric piano

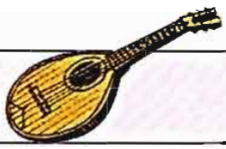

1

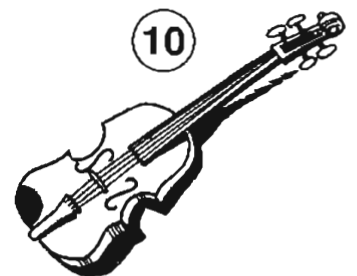
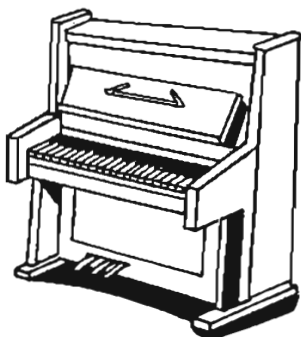
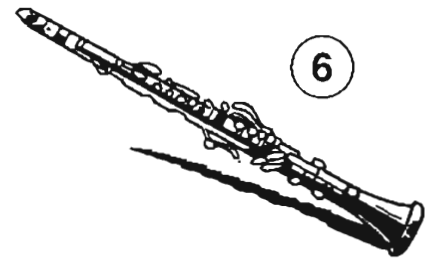
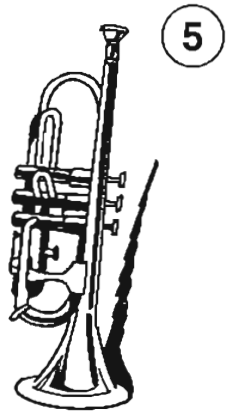
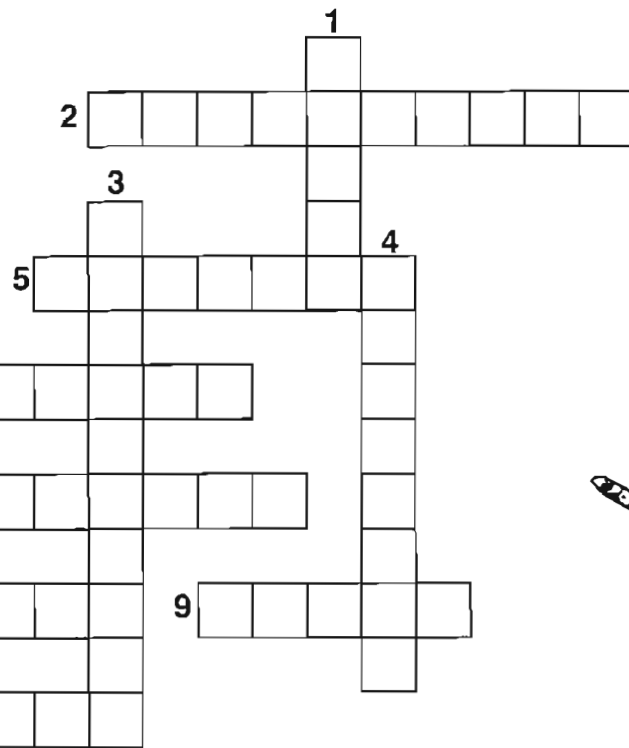
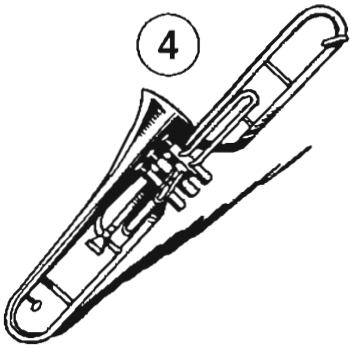
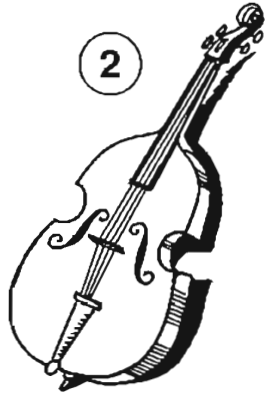
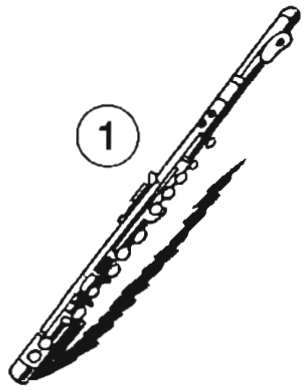

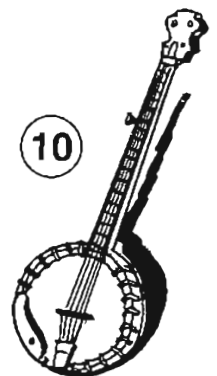
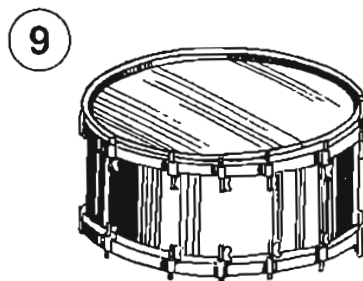
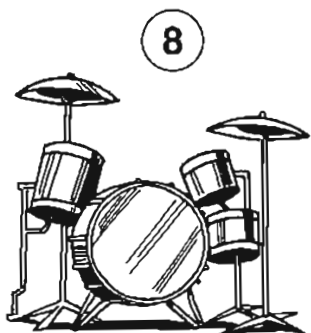
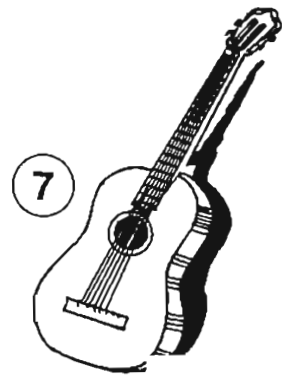
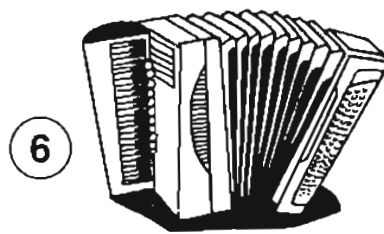
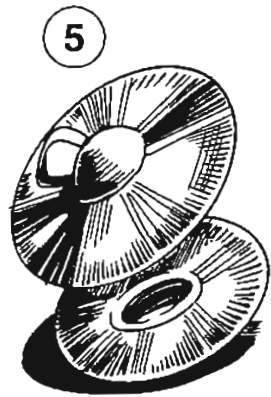
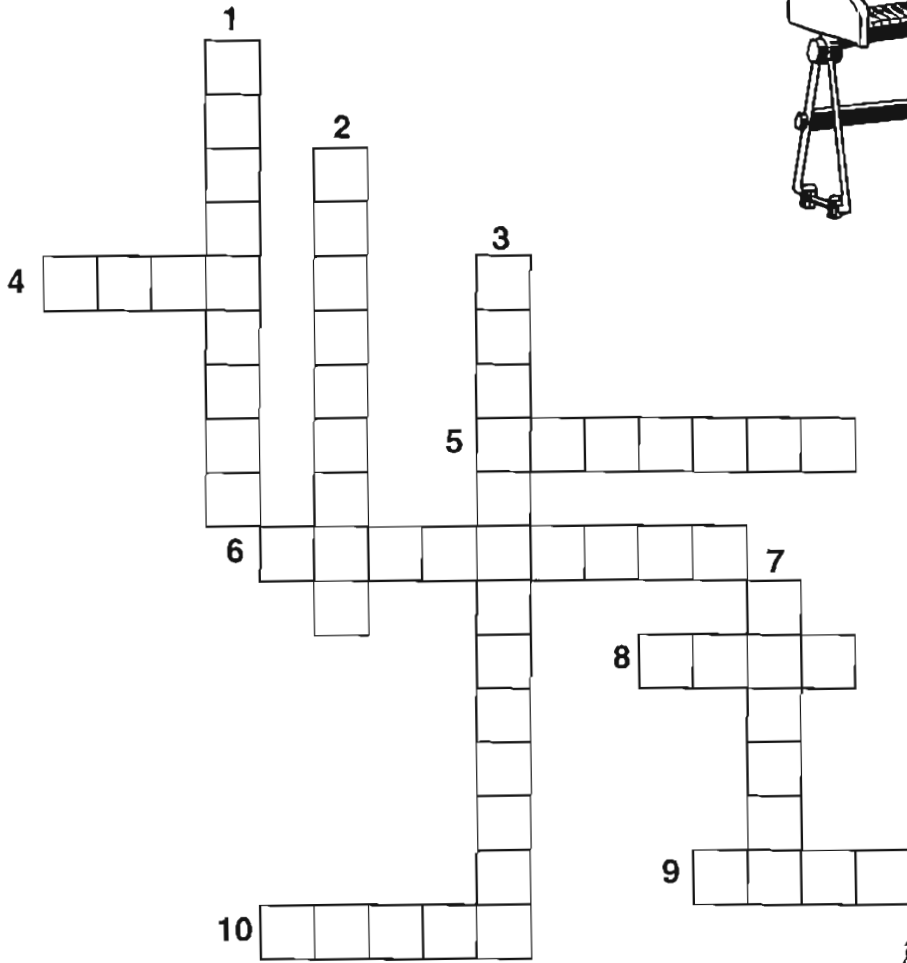
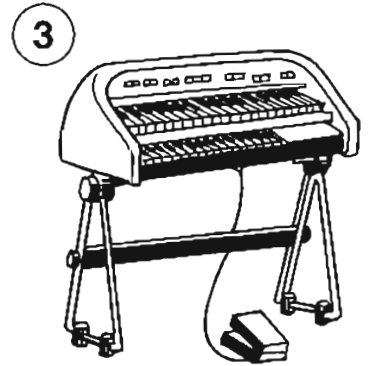
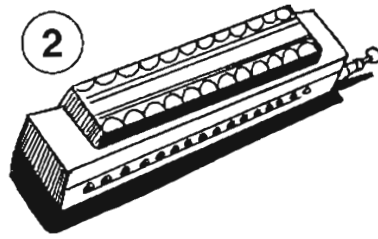
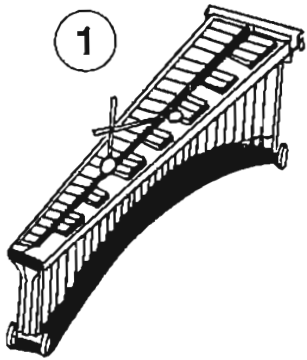
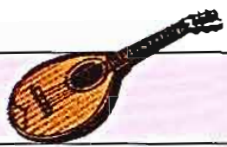

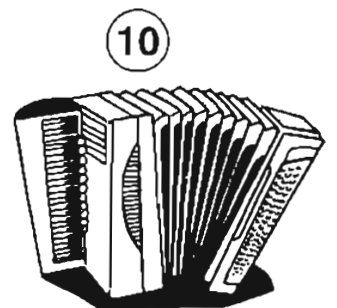
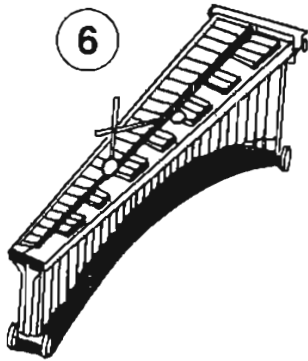
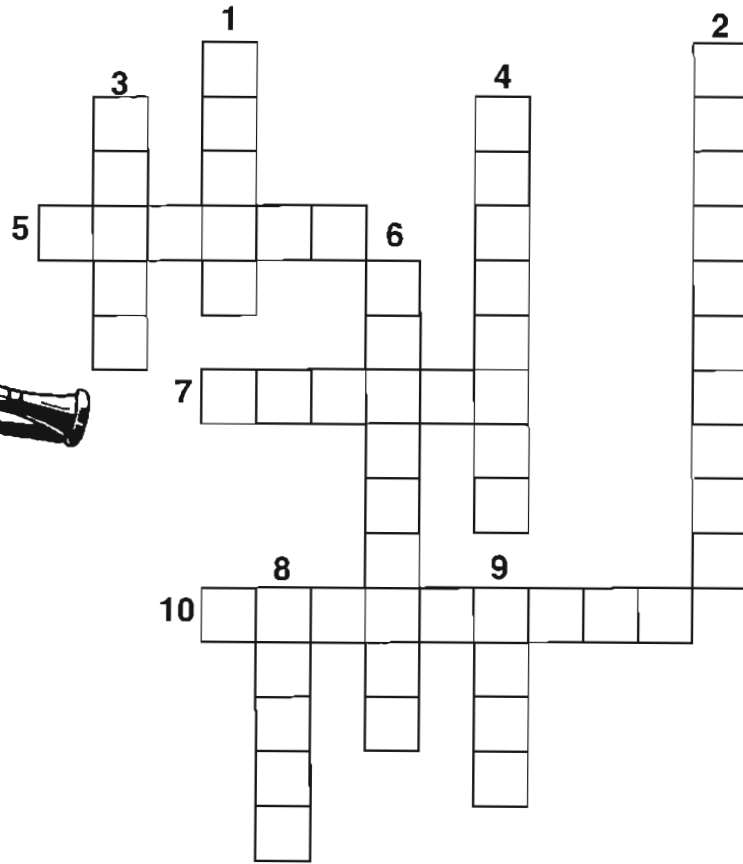
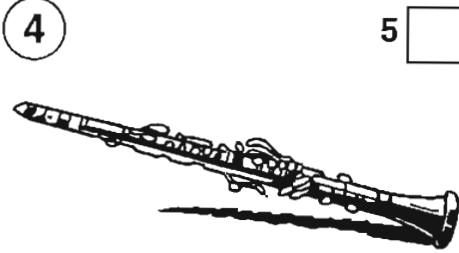
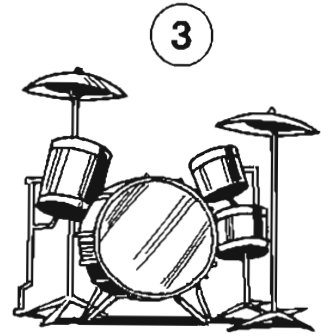
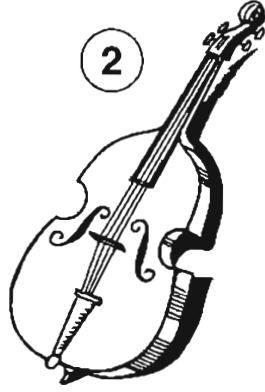
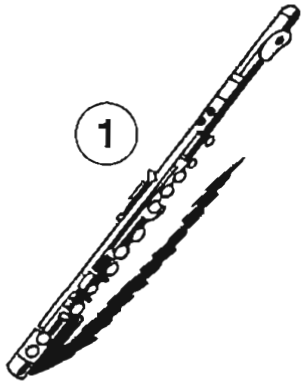
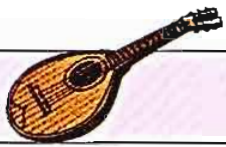

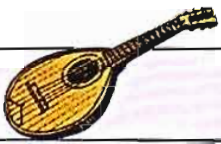

1

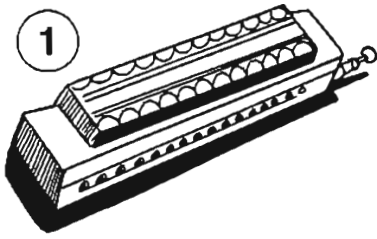

2

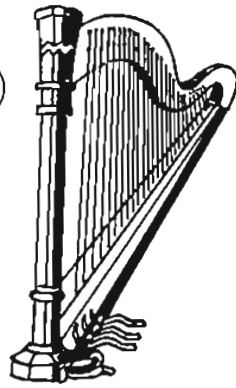

3

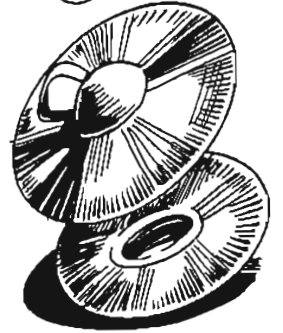

4

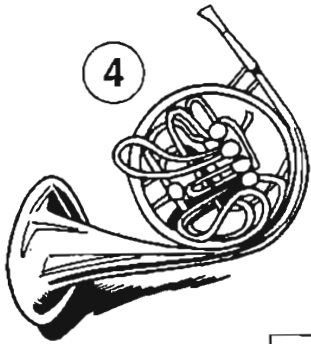

5

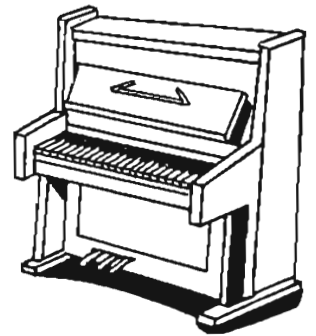

1

2

4

3

5

7

6

8

9

6

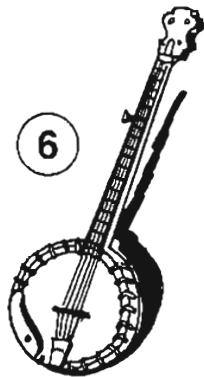

10

7



8



9

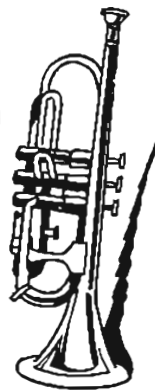

10

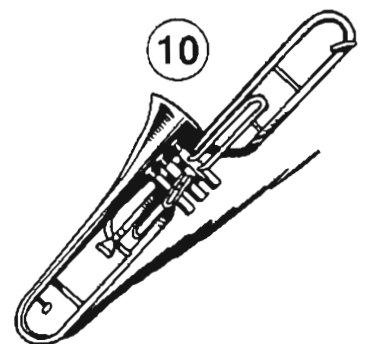

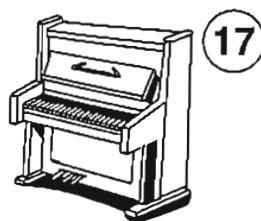
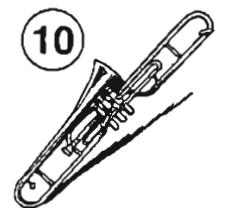
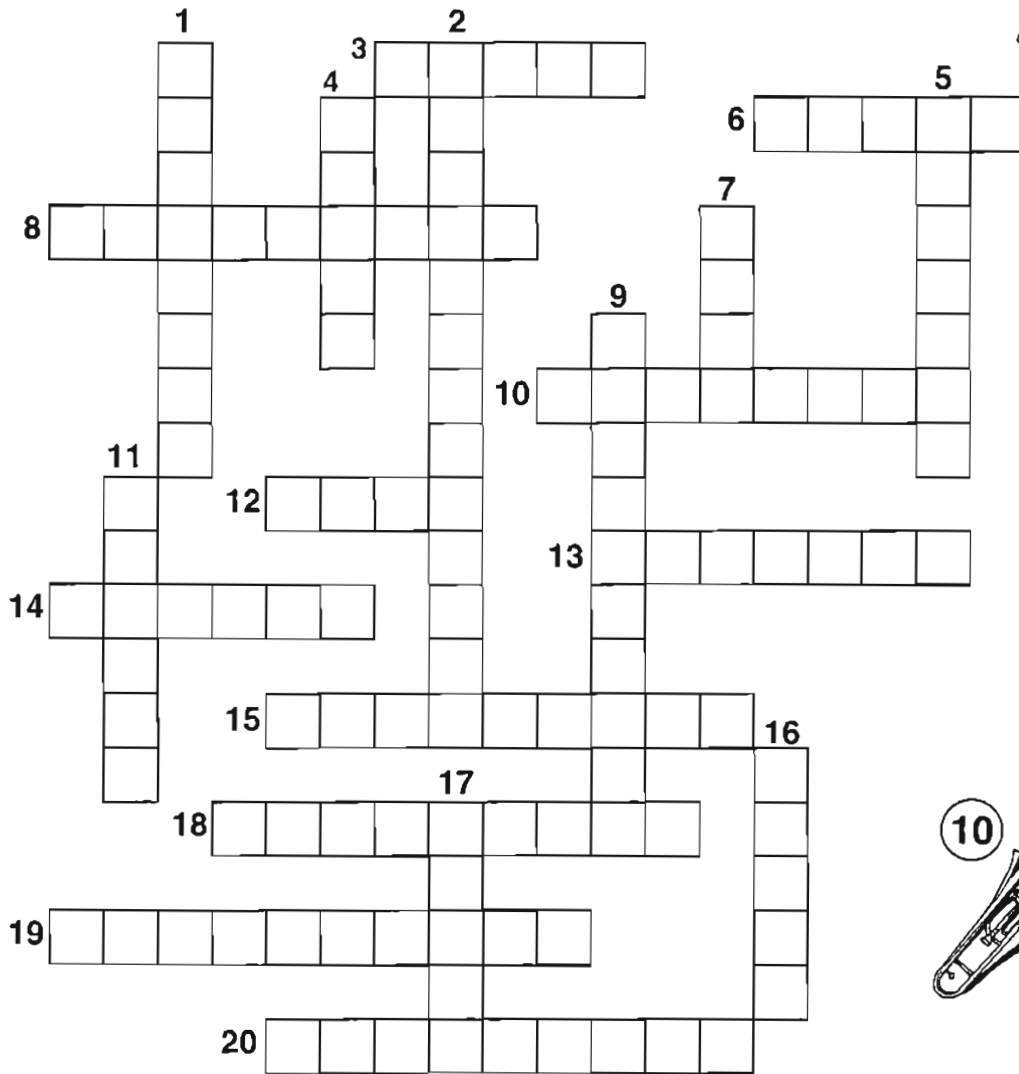
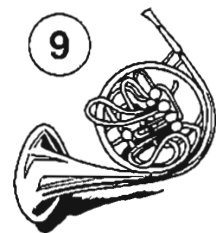
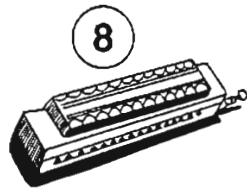
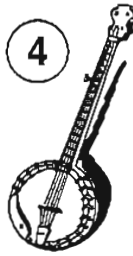
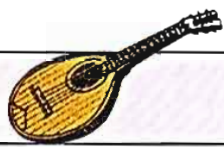



ADJECTIVES



thick



thin



high



low



old



young



strong



weak



wide



narrow



light



dark



alive



dead

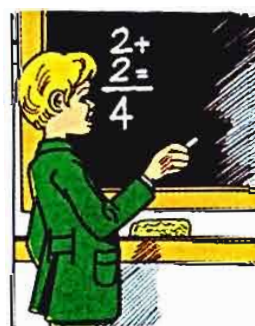

easy

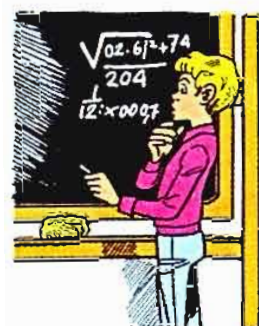

difficult



interested



bored



expensive



cheap

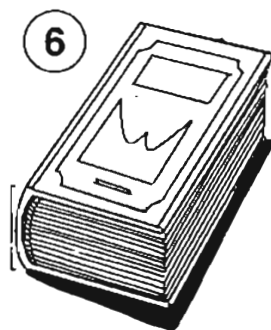
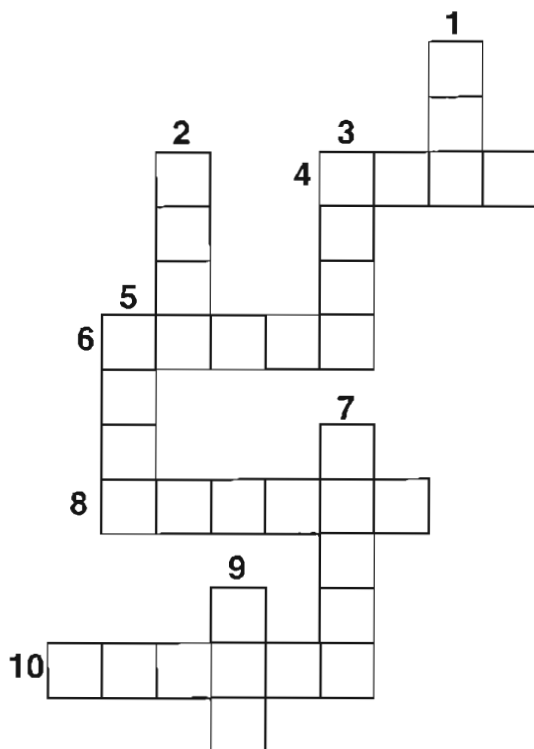
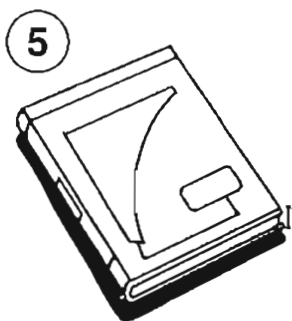

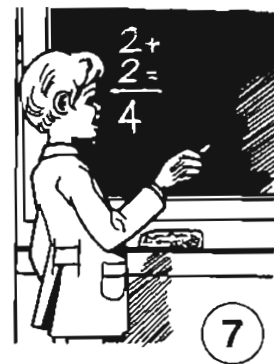
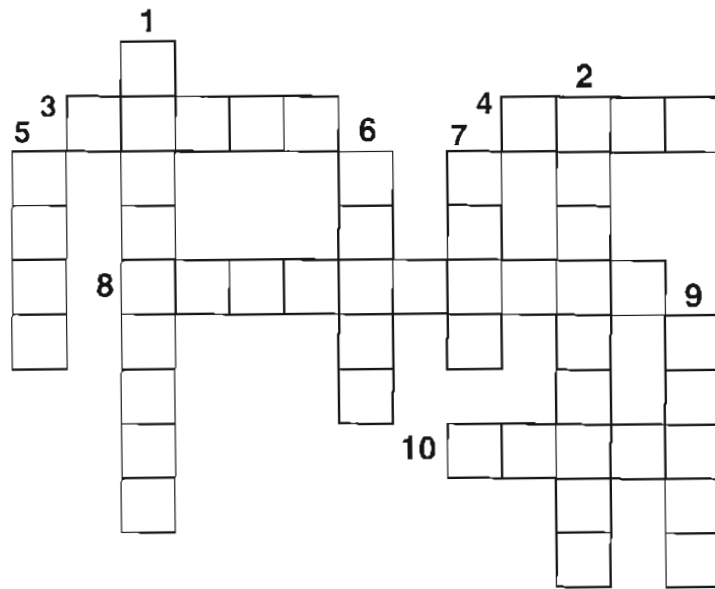
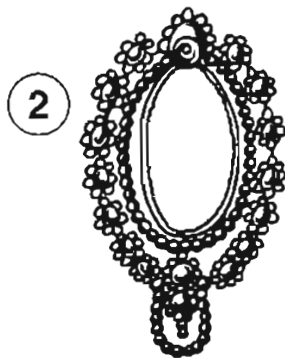
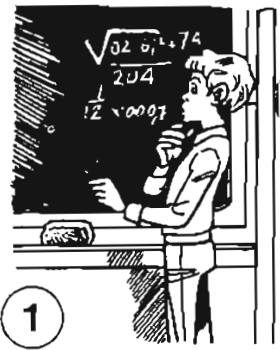

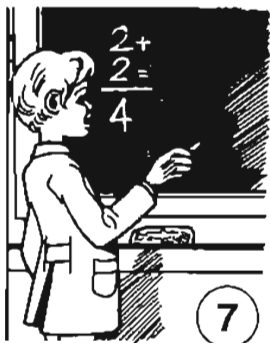
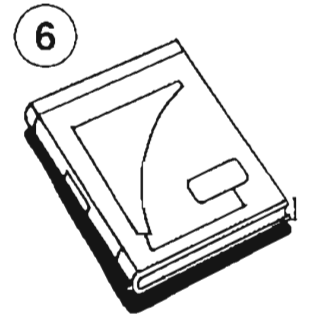
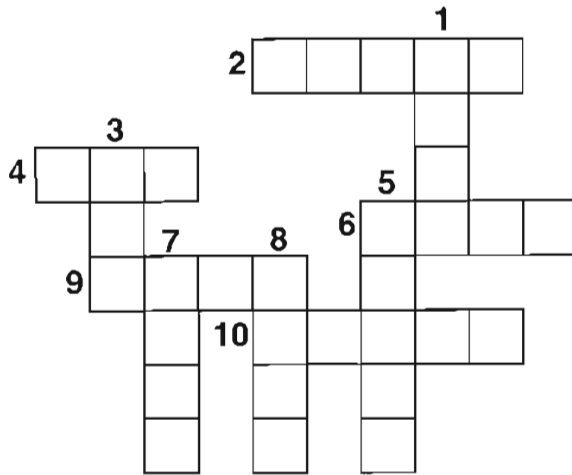
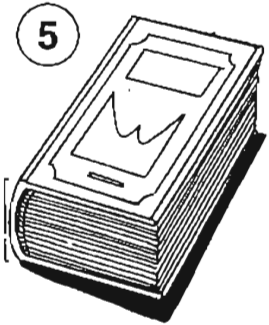

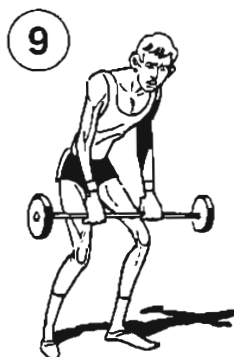
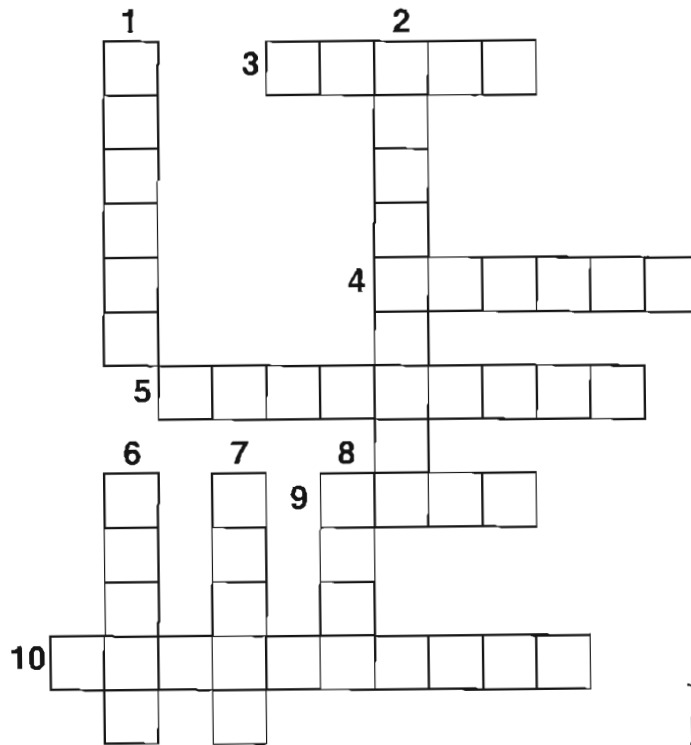
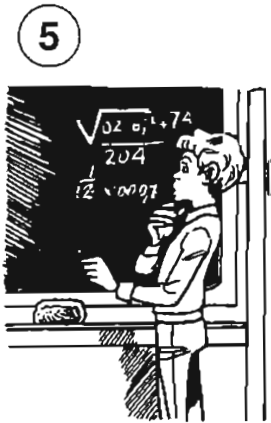
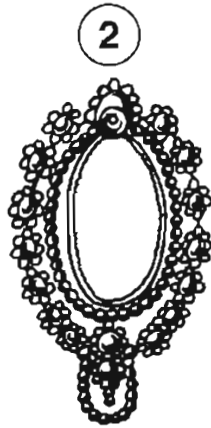



1



2



3

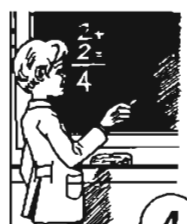

4

5



6



7



8

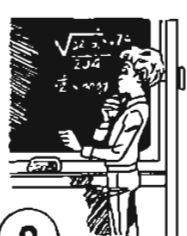

9



10

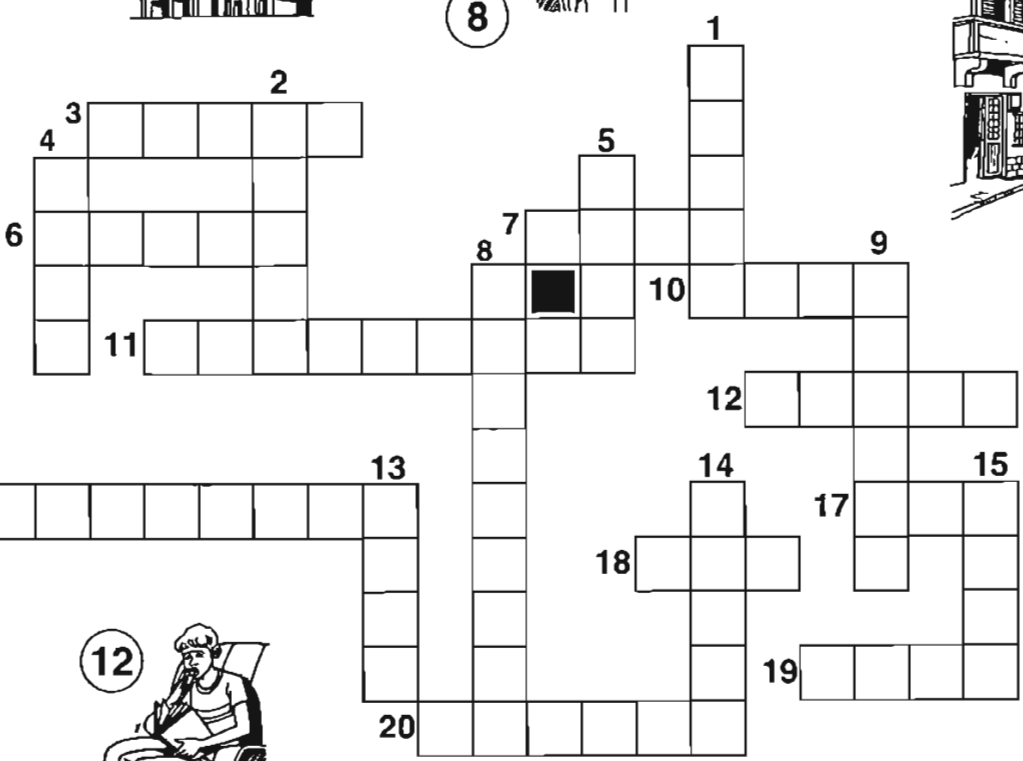
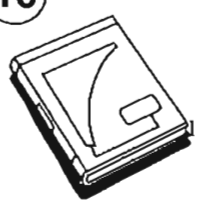

11



12



13



14



15



16



17



18



19



20





VERBS



shop



sell



study



find



dance



sing



think



take



build



give



get changed



help



run



jump



love



hate



leave



arrive



wait



carry

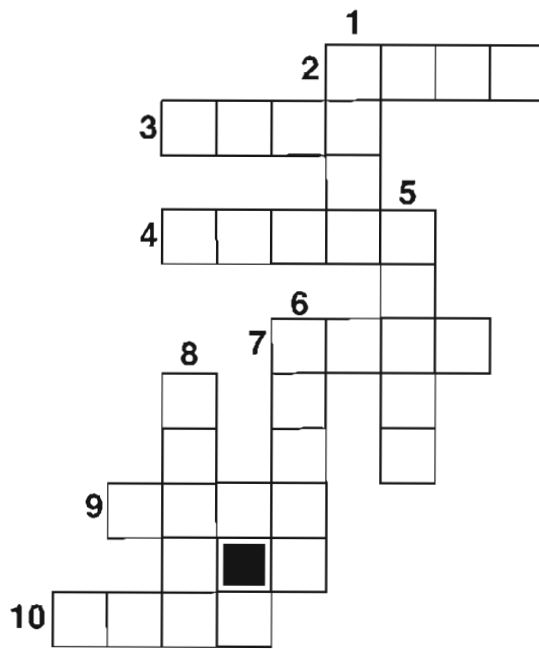
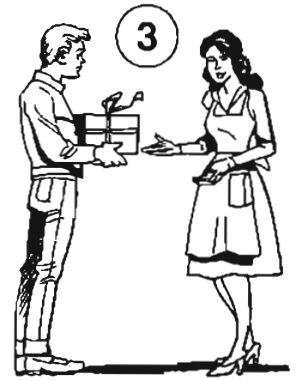

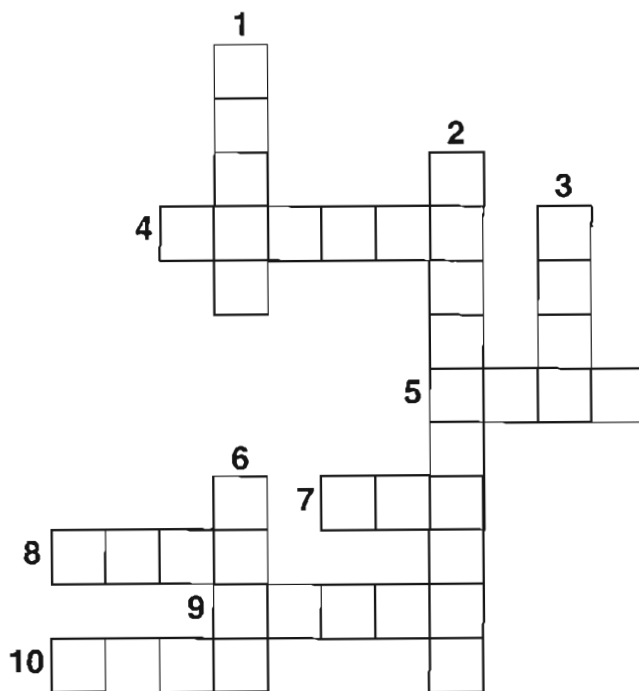
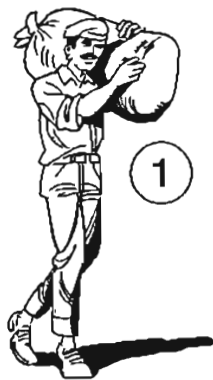

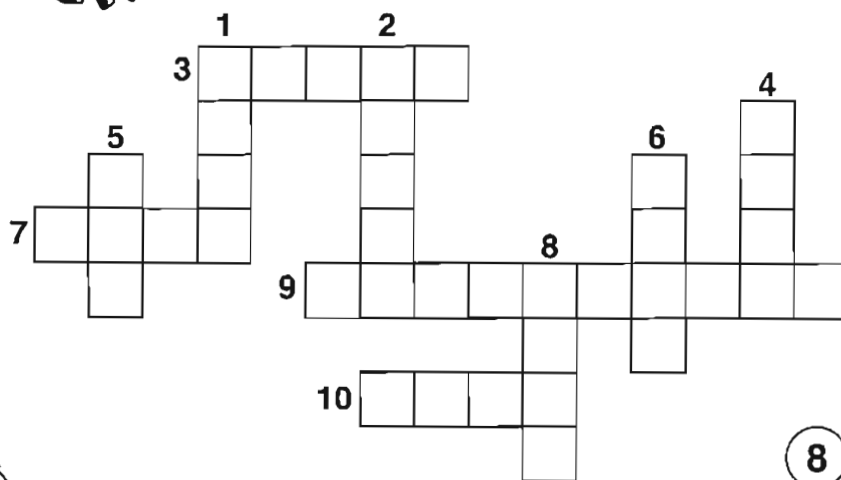

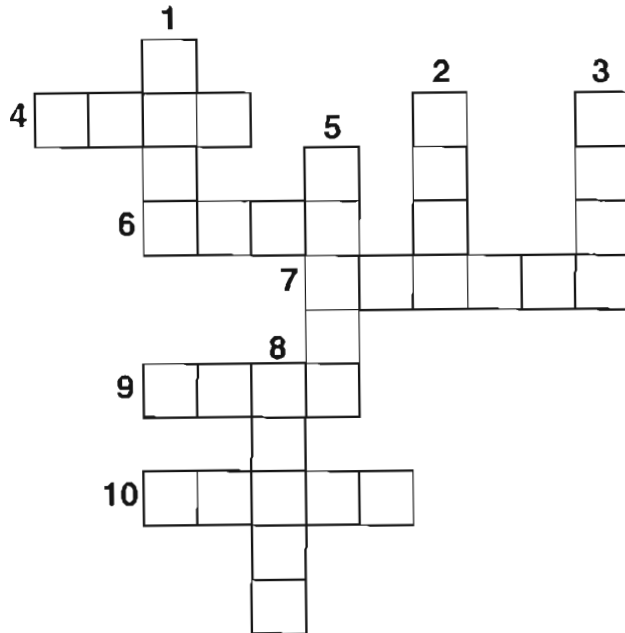

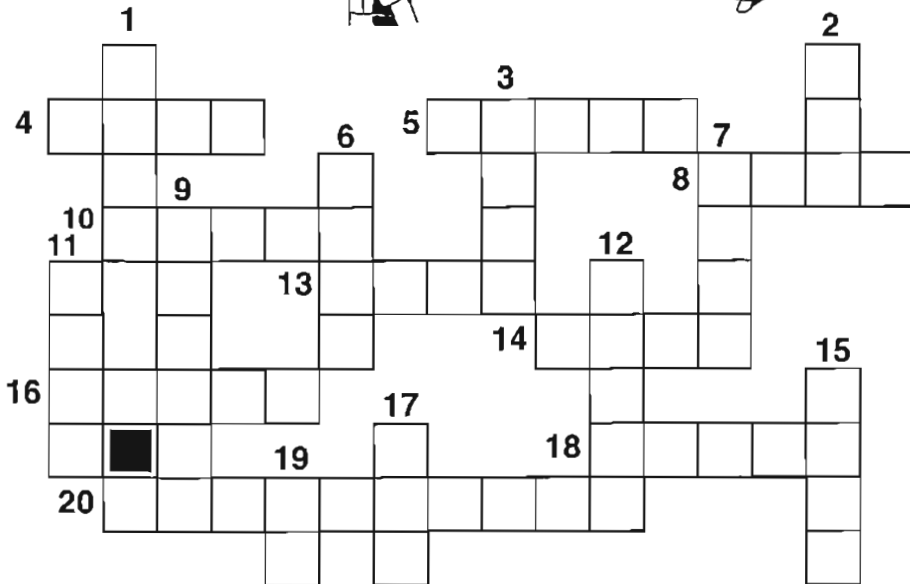



AT THE SEASIDE

page 4

beach	fish	lighthouse	shells
beach towel	fisherman	mask	sunglasses
beach umbrella	fishing rod	pier	sun hat
boat	flippers	sand-castle	swimming costumes
deck chair	island	sea	waves



SEA FRIENDS

page 10

cod	jellyfish	sea horse	starfish
crab	killer whale	sea urchin	sword fish
dolphin	lobster	shark	tuna
hammerhead shark	octopus	skate	turtle
herring	prawn	sole	whale

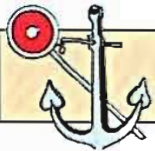

AT THE PORT AND THE RAILWAY STATION

page 16

anchor	deck	lifeboat	stationmaster
bow	engine	platform	stern
cabin	engine-driver	rails	ticket collector
captain	gangway	sailor	train
carriage	goods train	ship	window



FEATURES

page 24

beard	eye	hair	mouth
cheeks	eyebrow	head	neck
chin	eyelashes	jaw	nose
ear lobe	face	lip	teeth
ears	forehead	moustache	tongue



THE BODY

page 28

ankles	elbow	heels	thighs
arms	feet	knees	thumbs
back	fingers	legs	toes
calves	forearm	shoulders	waist
chest	hands	stomach	wrist



JOB

page 34

bricklayer	electrician	housewife	singer
carpenter	factory worker	mechanic	shop assistant
clerk	farmer	plumber	teacher
cook	fireman	postman	vet
doctor	hairdresser	secretary	waiter

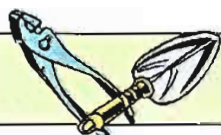

TOOLS

page 40

drawing pins	hoe	rasp	shovel
drill	nails	sandpaper	spade
garden fork	pincers	saw	spanner
hammer	pliers	screwdriver	stepladder
hatchet	rake	screws	tape measure



IN THE KITCHEN

page 46

blender	dishes	knife	spoon
bottle	fork	lid	teapot
bottle opener	frying pan	matches	teaspoon
bowl	glass	saucepans	tin
cup	kettle	saucer	tin opener

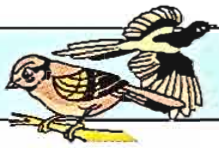

BIRDS

page 52

blackbird	falcon	peacock	sparrow
canary	flamingo	pelican	stork
crow	magpie	pigeon	swallow
dove	owl	robin	swan
eagle	parrot	seagull	woodpecker



AT THE AIRPORT

page 58

airport	landing gear	pilot	steps
aisle	luggage	plane	steward
cockpit	passenger lounge	runway	stewardess
control tower	passengers	seat	ticket
customs	passport	seat belt	wings



FLOWERS

page 64

anemone	forget-me-not	lily of the valley	poppy
carnation	gladiolus	mimosa	rose
cyclamen	hyacinth	narcissus	sunflower
daffodil	iris	orchid	tulip
daisy	lily	pansy	violet

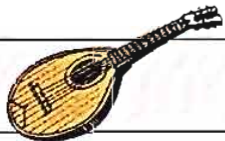

MUSICAL INSTRUMENTS

page 70

accordion	cymbals	French horn	saxophone
banjo	drum	guitar	trombone
double bass	drums	harmonica	trumpet
cello	electric piano	harp	violin
clarinet	flute	piano	xylophone



ADJECTIVES

page 76

alive	difficult	light	thick
bored	easy	low	thin
cheap	expensive	narrow	weak
dark	high	old	wide
dead	interested	strong	young



VERBS

page 82

arrive	get changed	leave	sing
build	give	love	study
carry	hate	run	take
dance	help	sell	think
find	jump	shop	wait



An entertaining and effective way to learn new vocabulary.

- Illustrated words make meaning immediate.
- New words are reinforced and recycled in a series of picture crosswords.
- Suitable for self-study or class work.
- Learning English with crosswords is easy and fun!

In this series:

ENGLISH WITH CROSSWORDS 1 Beginners

ENGLISH WITH CROSSWORDS 2 Intermediate

ENGLISH WITH CROSSWORDS 3 Advanced

The series is published in the following language versions:

French: le FRANÇAIS par les MOTS CROISÉS

German: mit KREUZWORTRÄTSELN DEUTSCH lernen

Spanish: el ESPAÑOL en CRUCIGRAMAS

Italian: l'ITALIANO con le PAROLE CROCIATE

ISBN 88-85148-18-2



9 788885 148185