

ENGLISH WITH CROSSWORDS





ENGLISH with **CROSSWORDS**



EUROPEAN LANGUAGE INSTITUTE



Language teachers all over the world agree that visual material can significantly aid the comprehension of new vocabulary. Pictures provide context and unambiguous meaning, thereby allowing students to learn and remember words more easily.

In **English with Crosswords** we develop this concept to the full introducing all new words within a chosen theme, each one alongside its visual representation. 20 words are introduced for each theme and practised in a series of 5 crosswords. Meaning is reinforced through word-picture association and words are recycled through repeated practice:

- In the first crossword students write the words corresponding to 10 illustrations in the crossword grid.
- In the second crossword the remaining 10 words are practised.
- In the third crossword a mixture of words from the first two crosswords is used and in the fourth one there is a mixture of the other 10 words.
- All 20 words are then brought together in the final crossword.

This appealing book is ideal for self-study or as a holiday refresher.

Learning English is easy and fun!



FARM ANIMALS

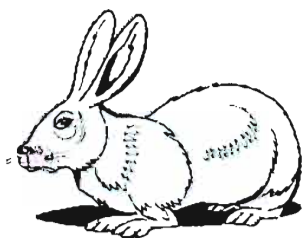

rabbit

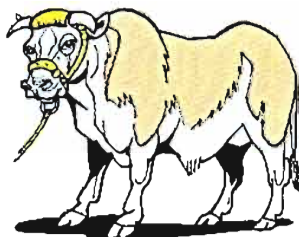

bull

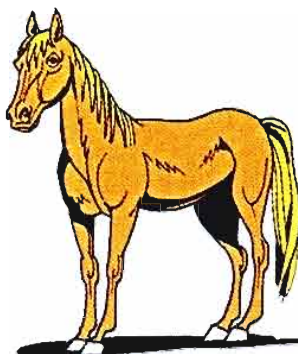

horse



cock

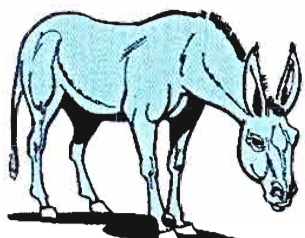

donkey

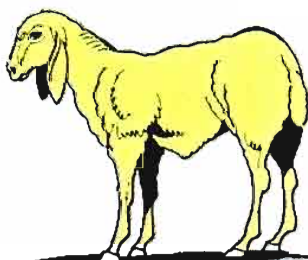

sheep

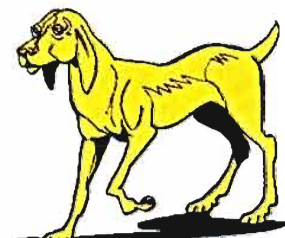

dog



cat

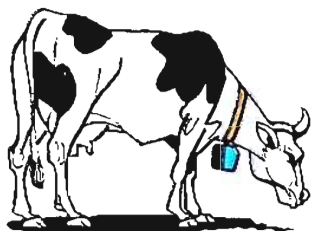

cow

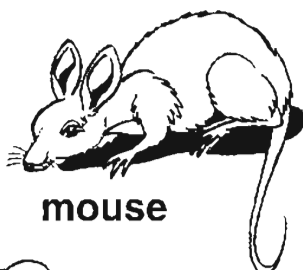

mouse

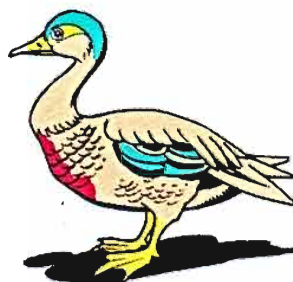

duck

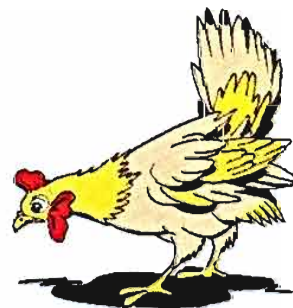

hen

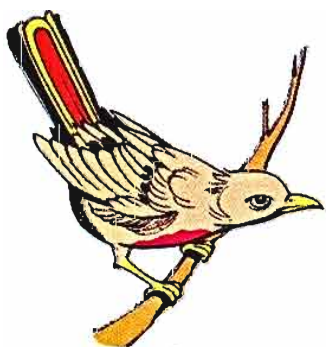

bird

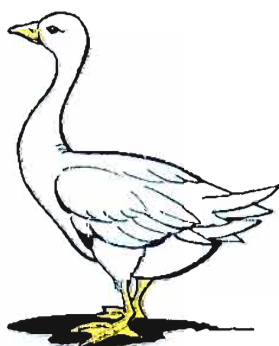

goose

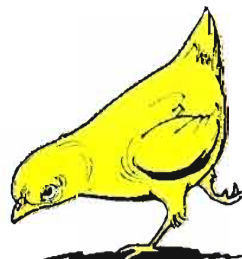

chick

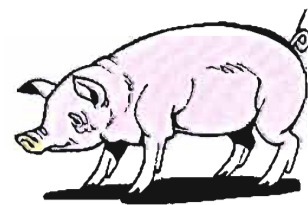

pig

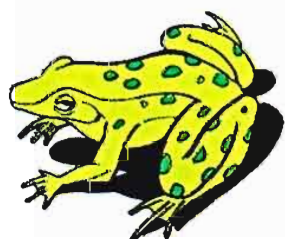

frog

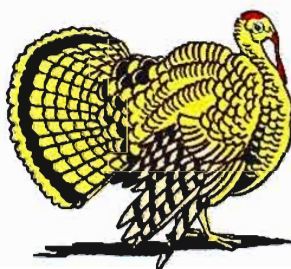

turkey



butterfly

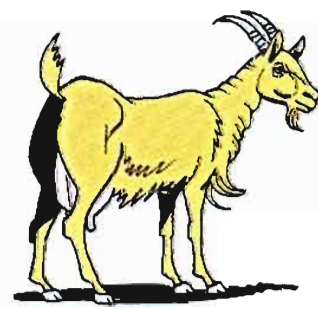

goat

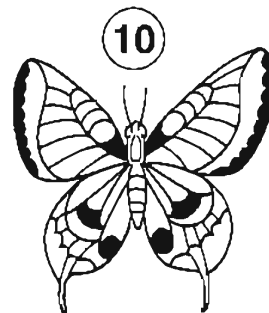
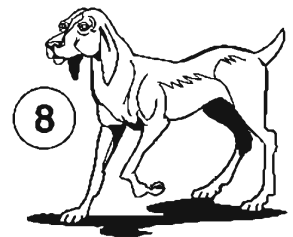
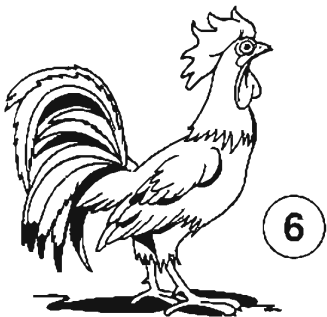
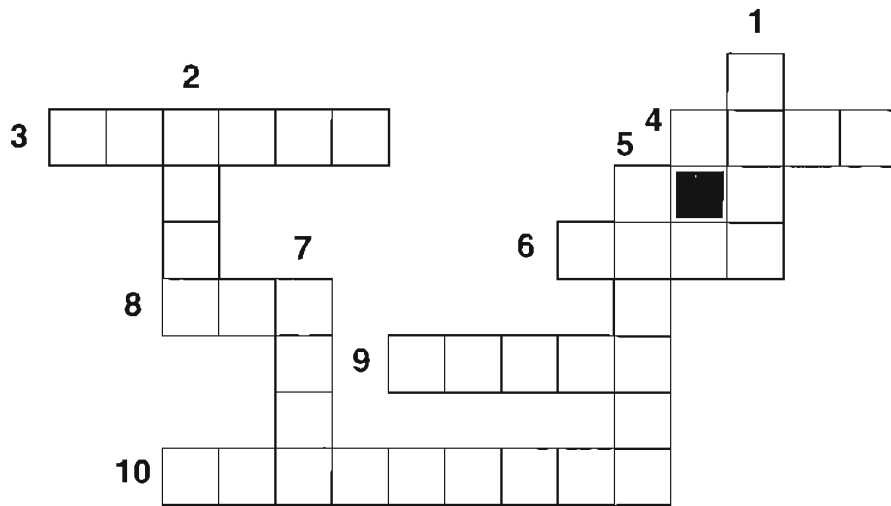
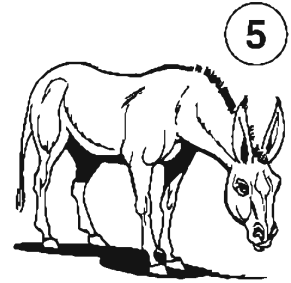
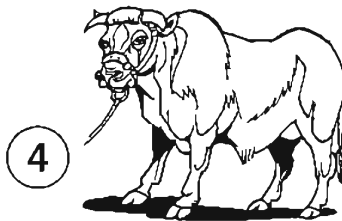
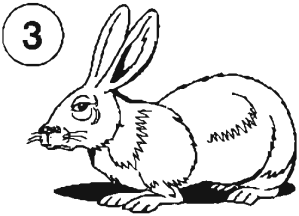
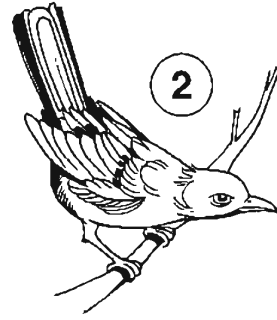
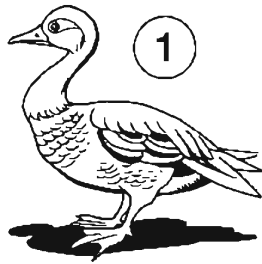

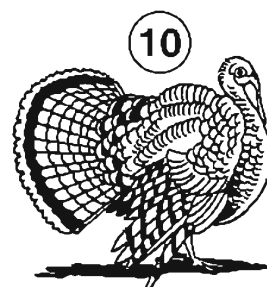
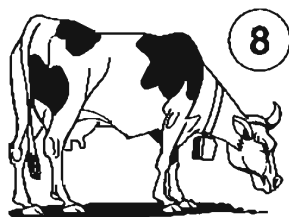
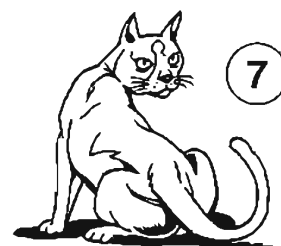
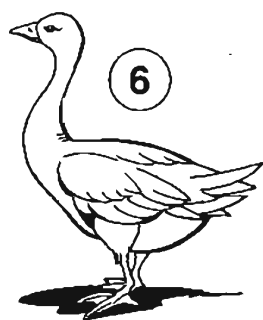
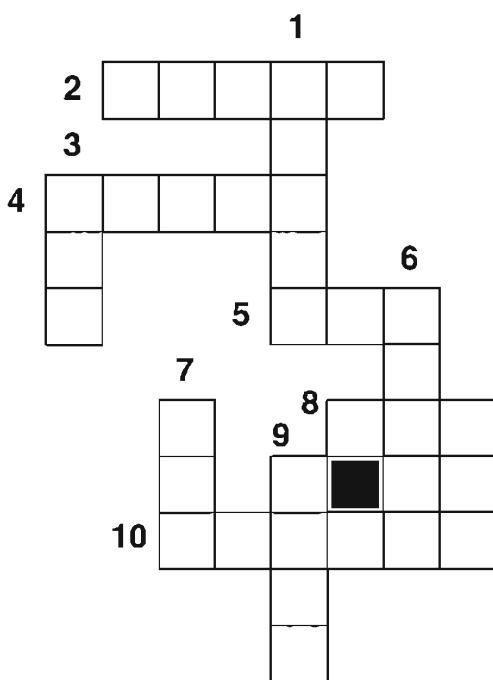
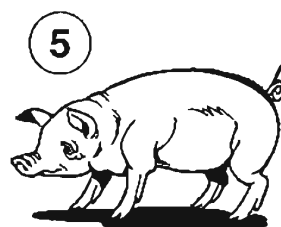
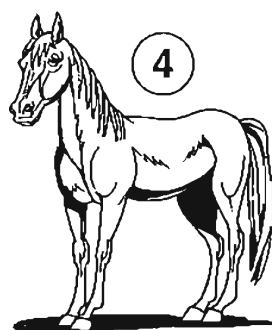
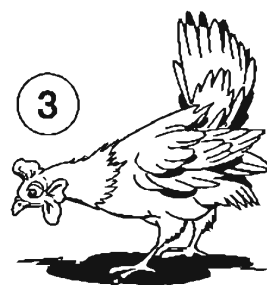
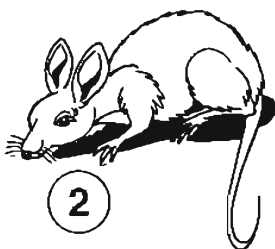
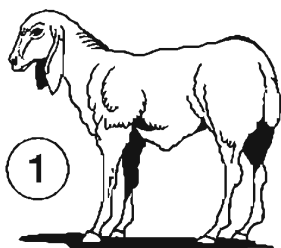

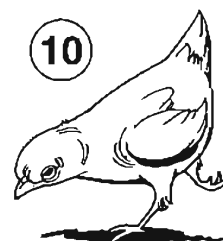
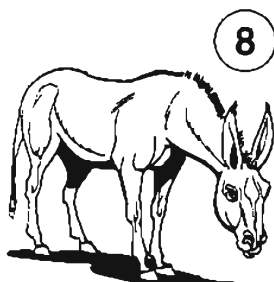
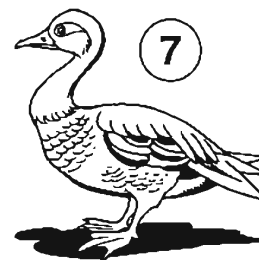
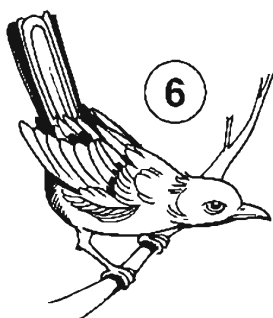
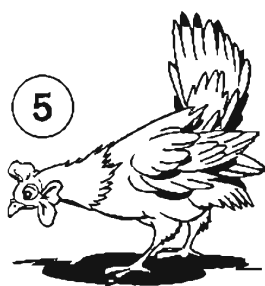
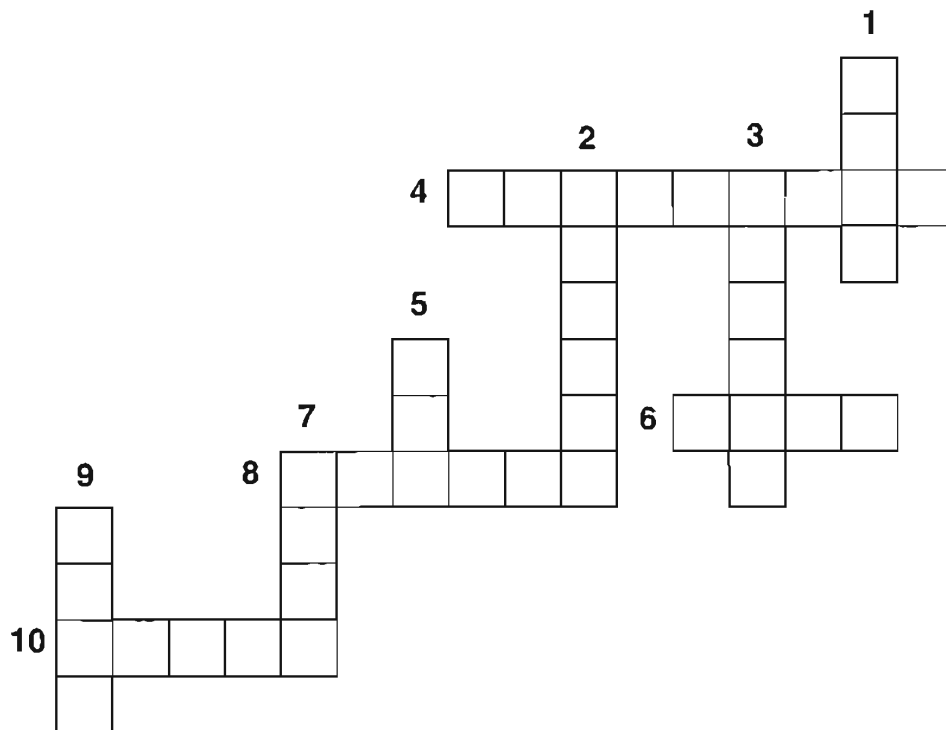
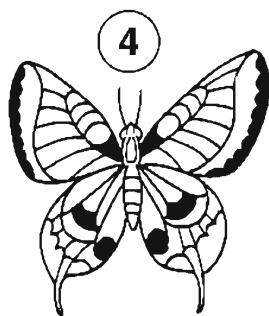
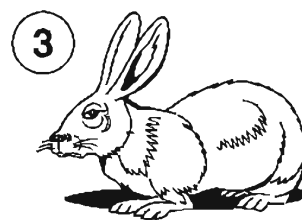
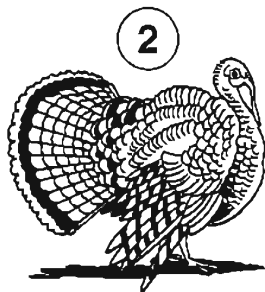
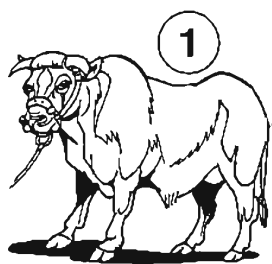

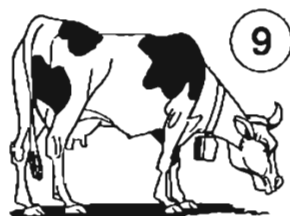
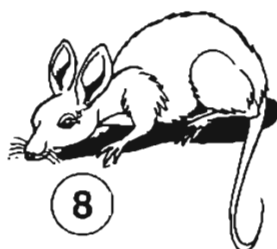
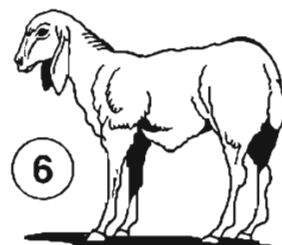
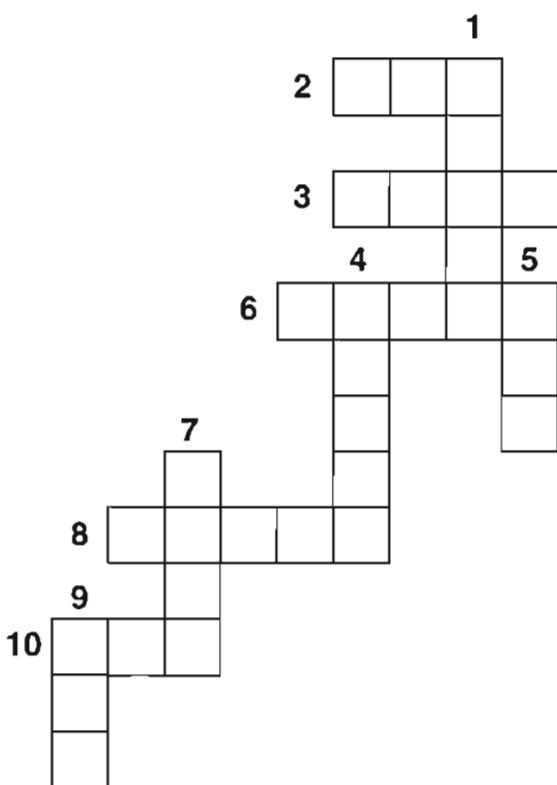
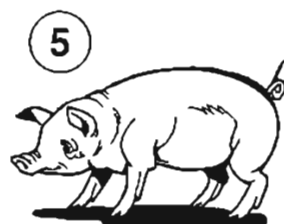
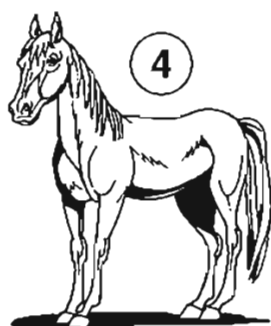
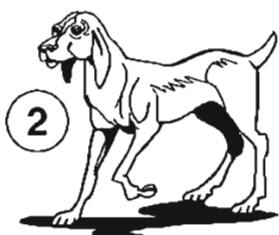
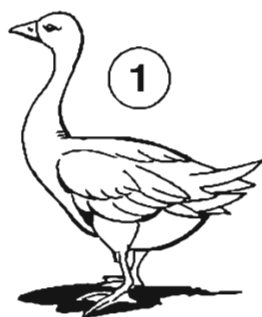

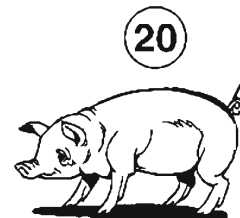
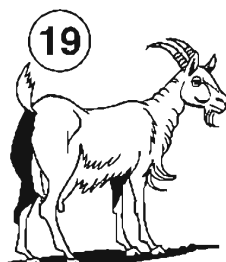
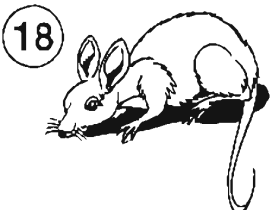
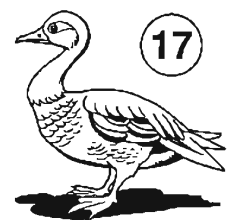
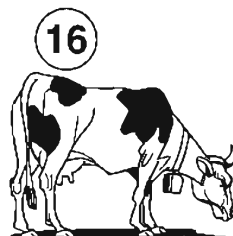
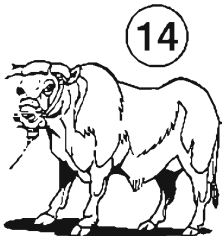
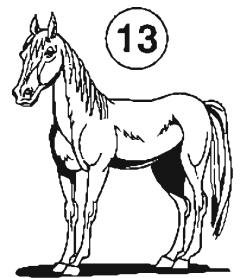
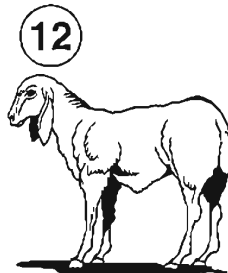
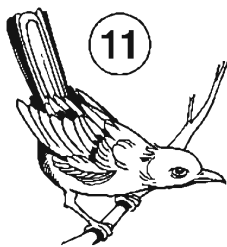
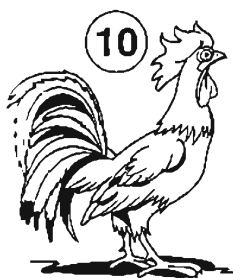
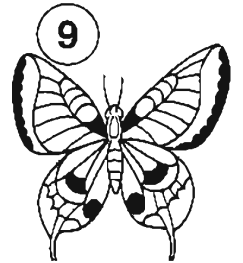
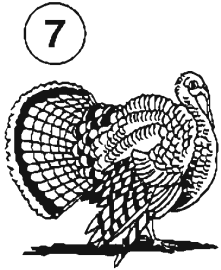
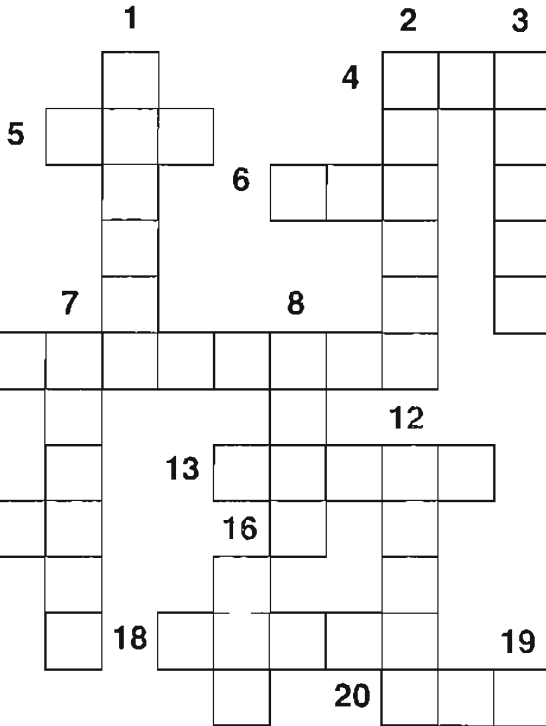
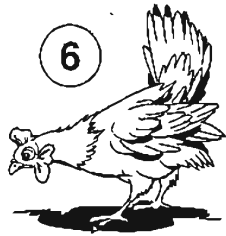
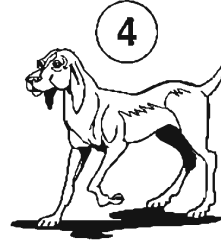
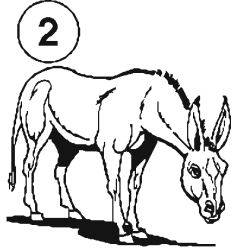
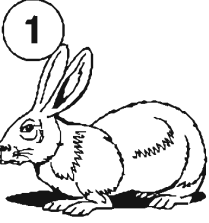



THE HOUSE



ceiling

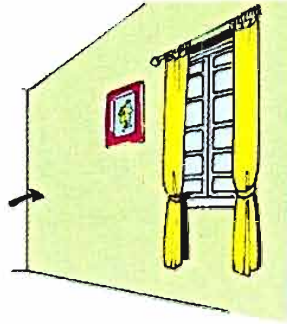

wall

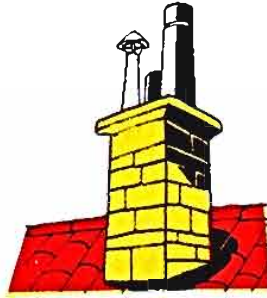

chimney

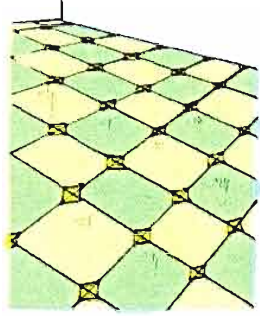

floor

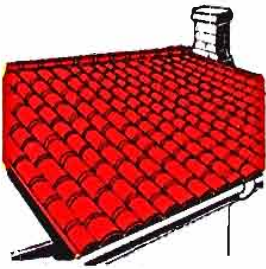

roof

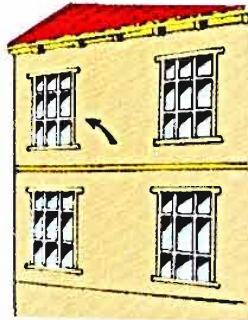

window

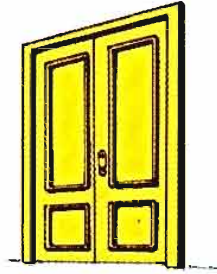

door



gate



bedroom



dining room



kitchen



bathroom



hall



steps

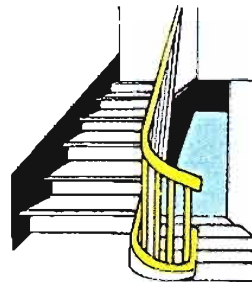

stairs

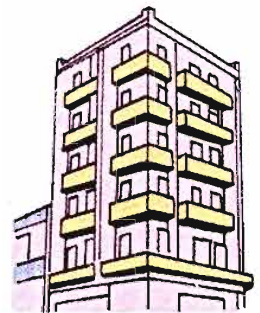

block of flats



house



flat



garage



garden



1



2

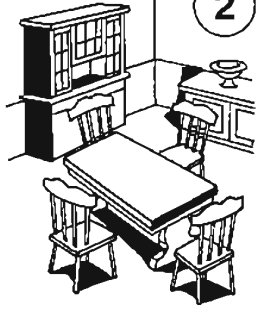

3



4

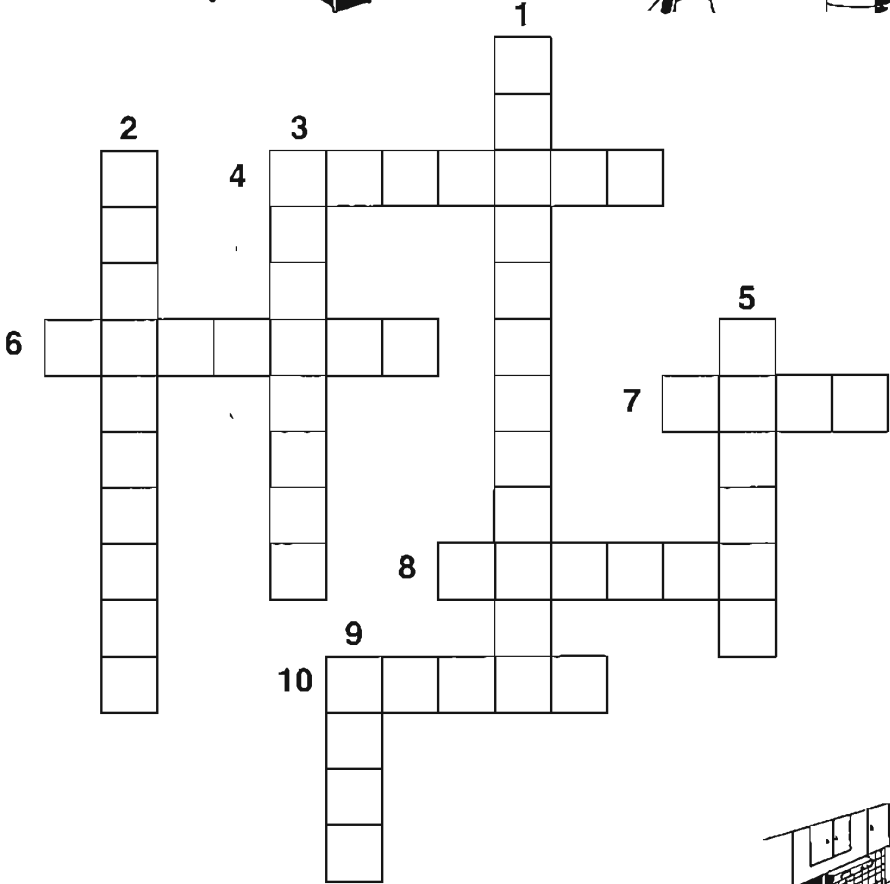

5

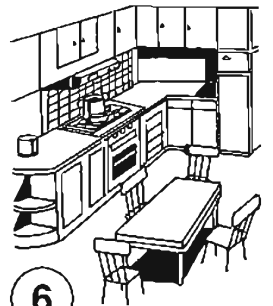

6

9



7

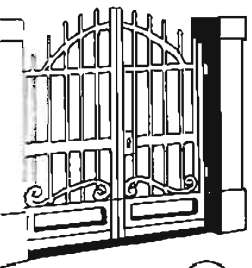

8

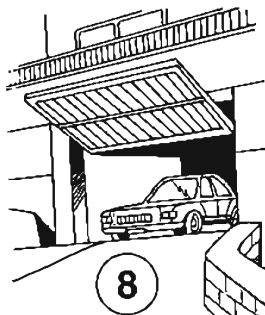

10



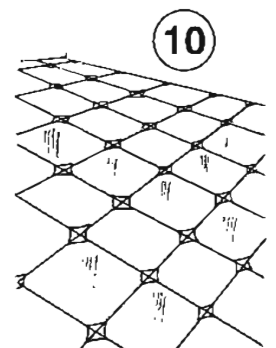
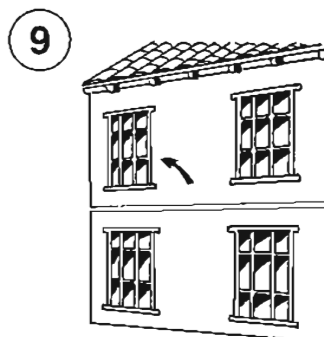
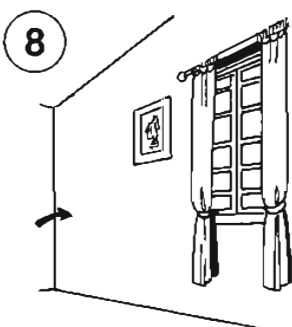
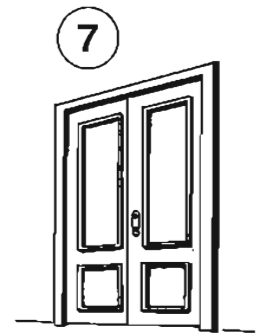
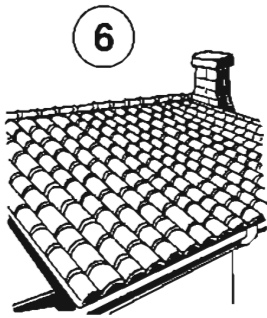
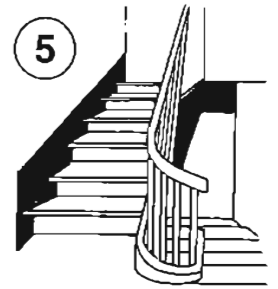
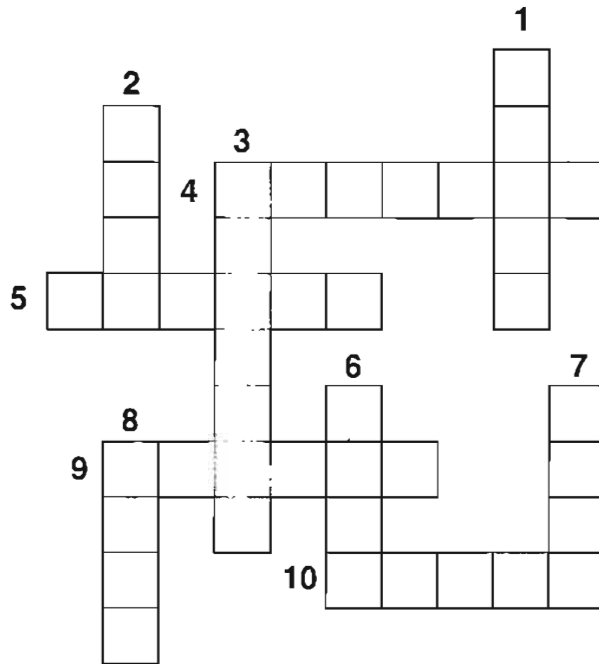
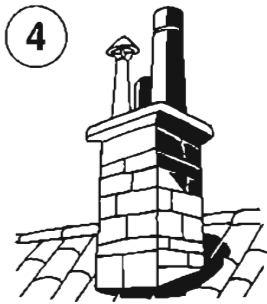
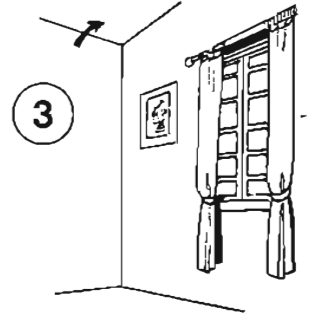
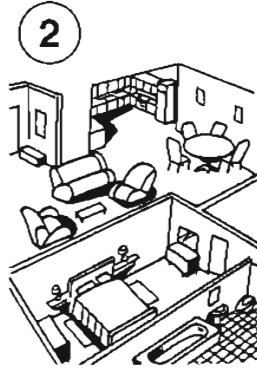
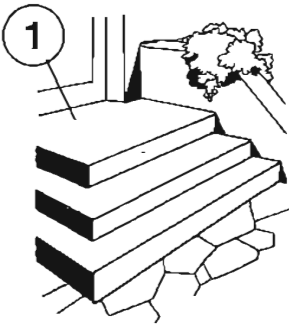



1



2

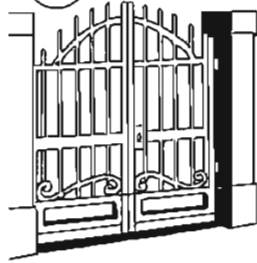

3



4

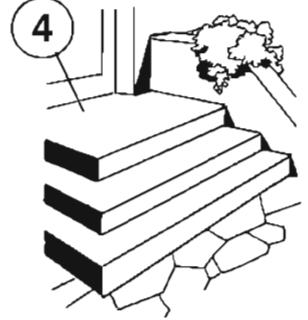

5

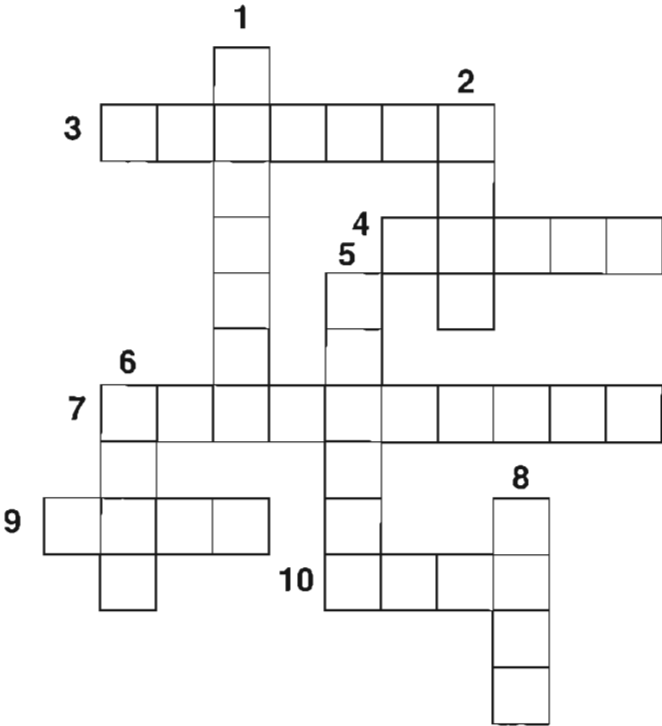
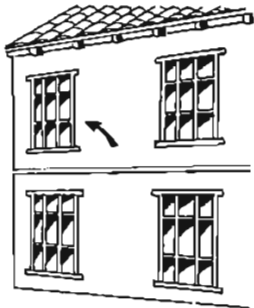

6

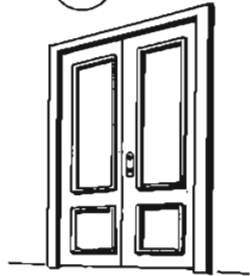

7

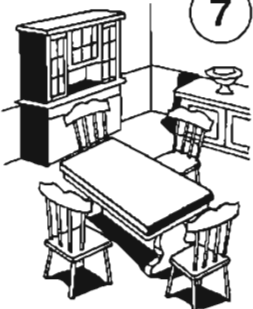

8



9

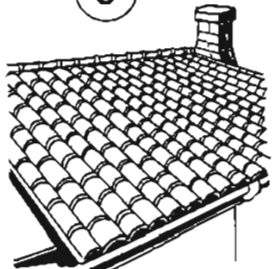

10



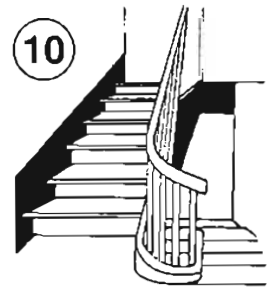
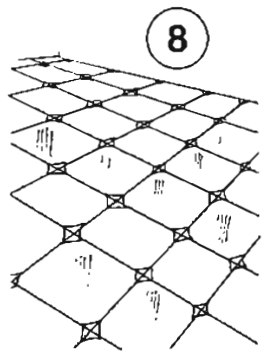
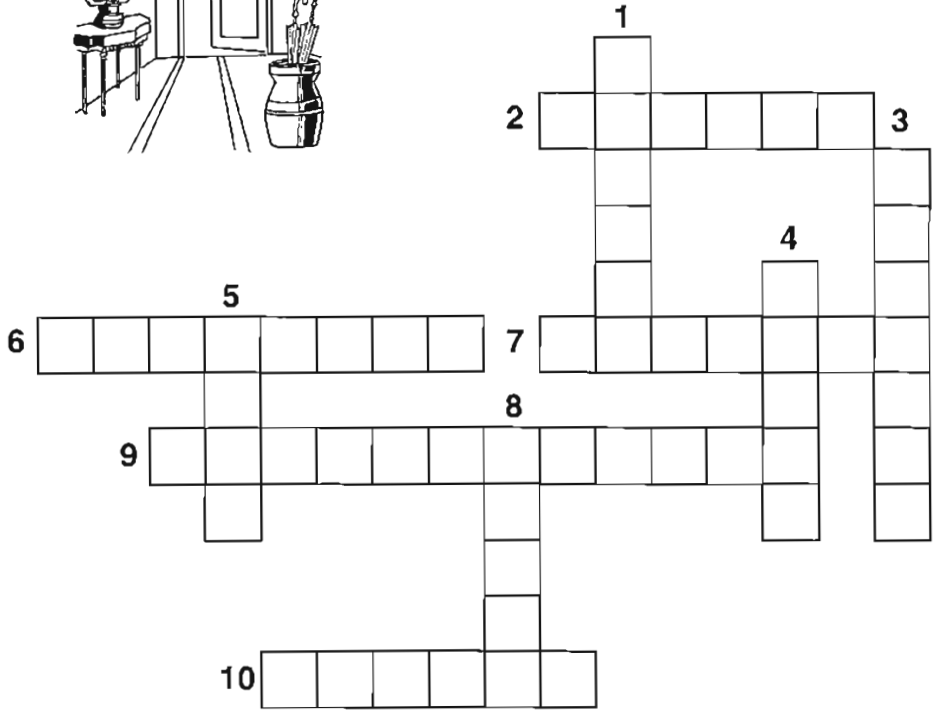
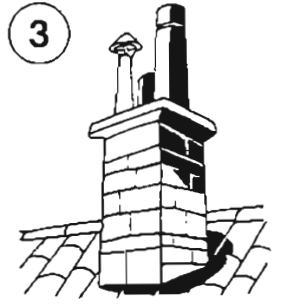
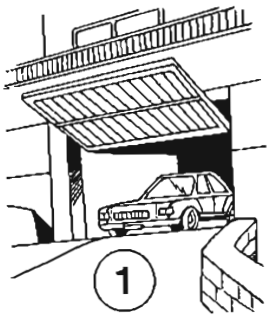

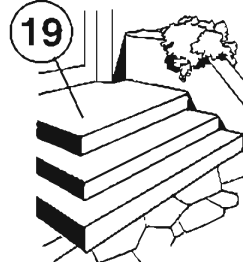
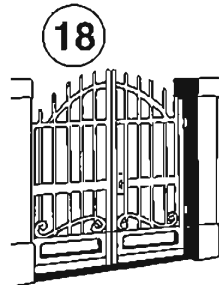
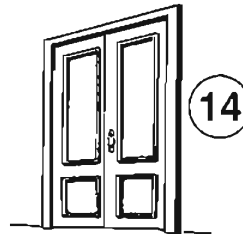
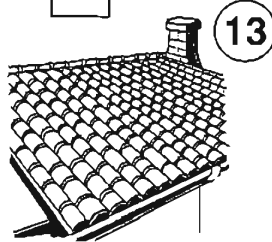
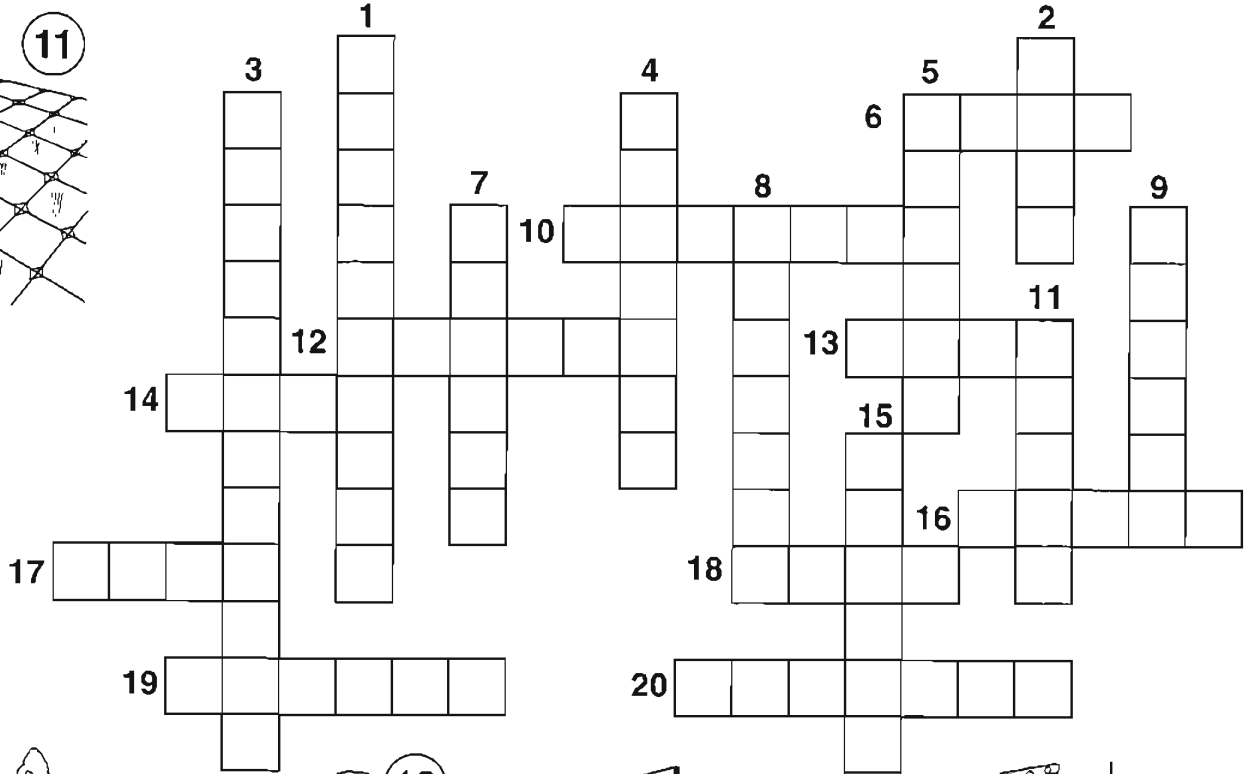
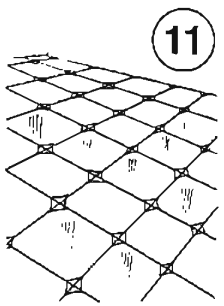
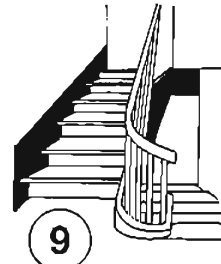
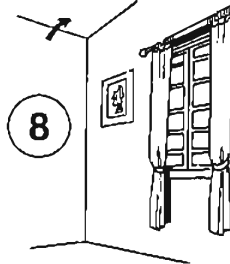
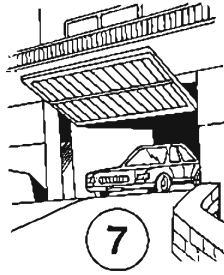
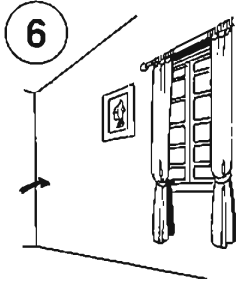
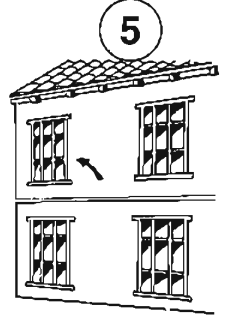
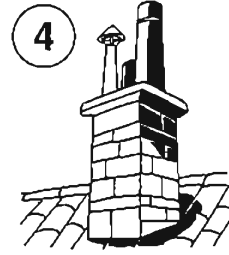
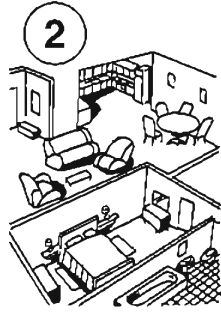
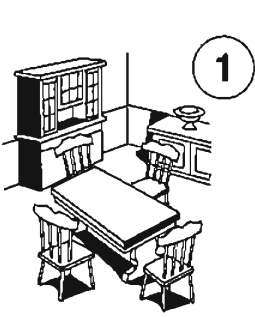



FURNITURE

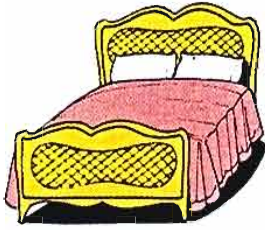

bed

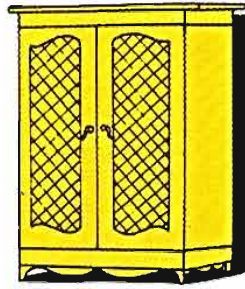

wardrobe

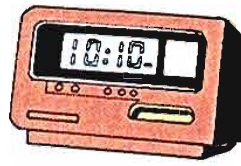

alarm clock

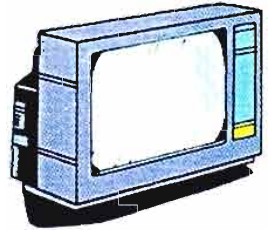

TV



armchair



sofa



table



chair



cushion



drawers

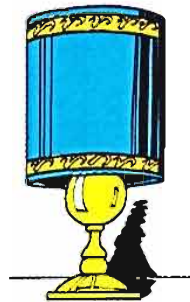

lamp

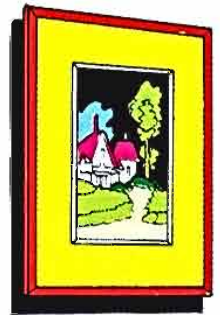

picture

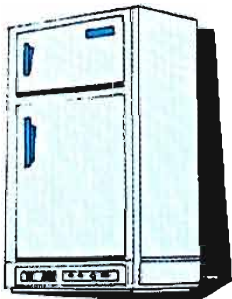

fridge



washing machine



washbasin

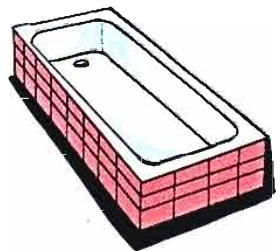

bath

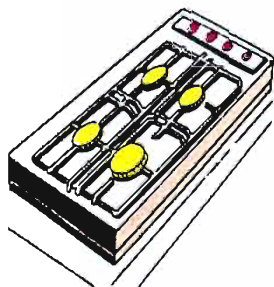

gas rings



sink



tap

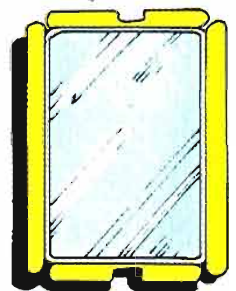

mirror

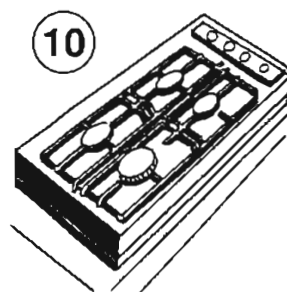
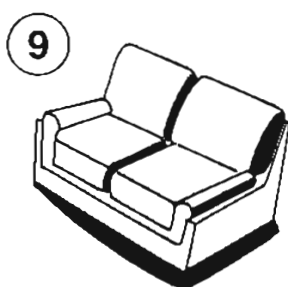
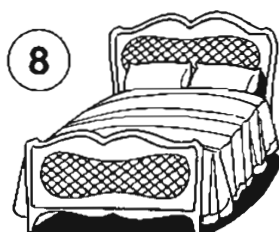
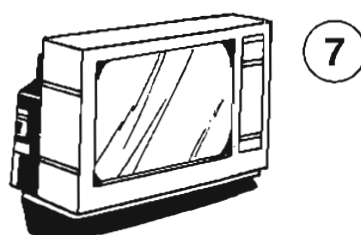
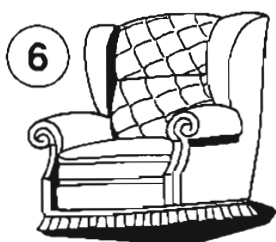
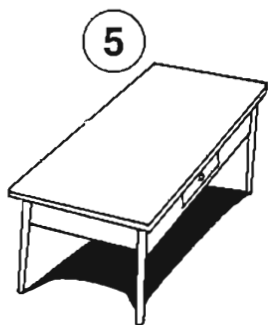
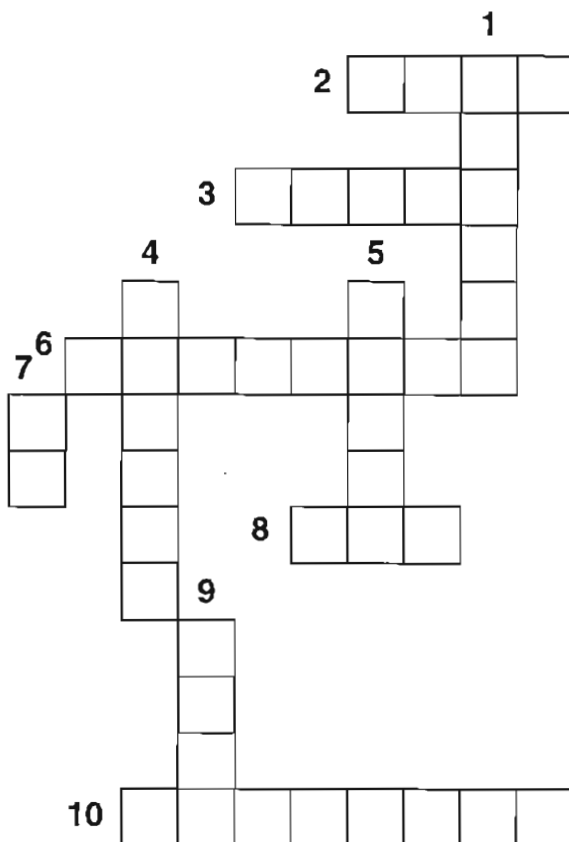
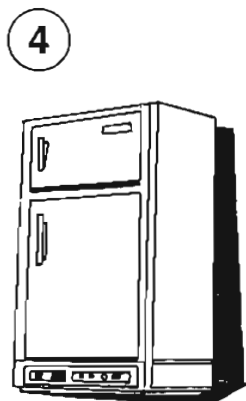
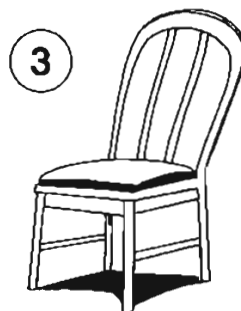
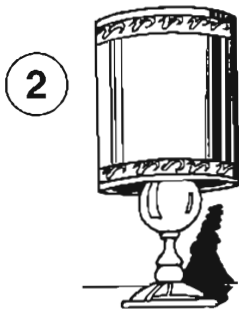
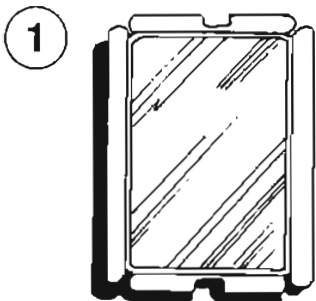

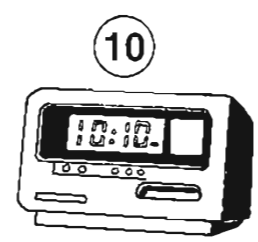
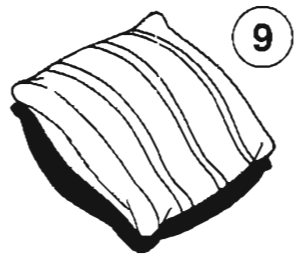
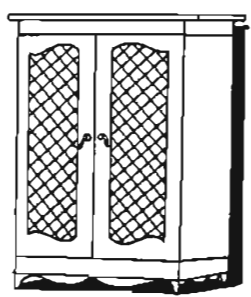
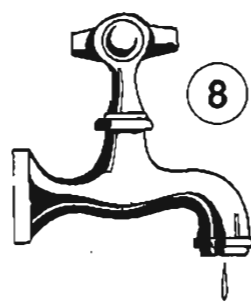
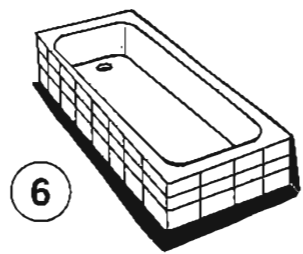
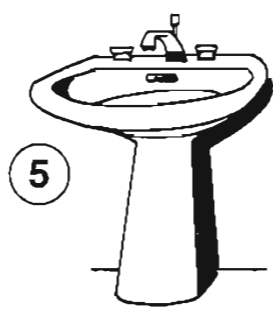
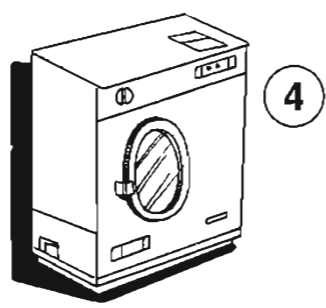
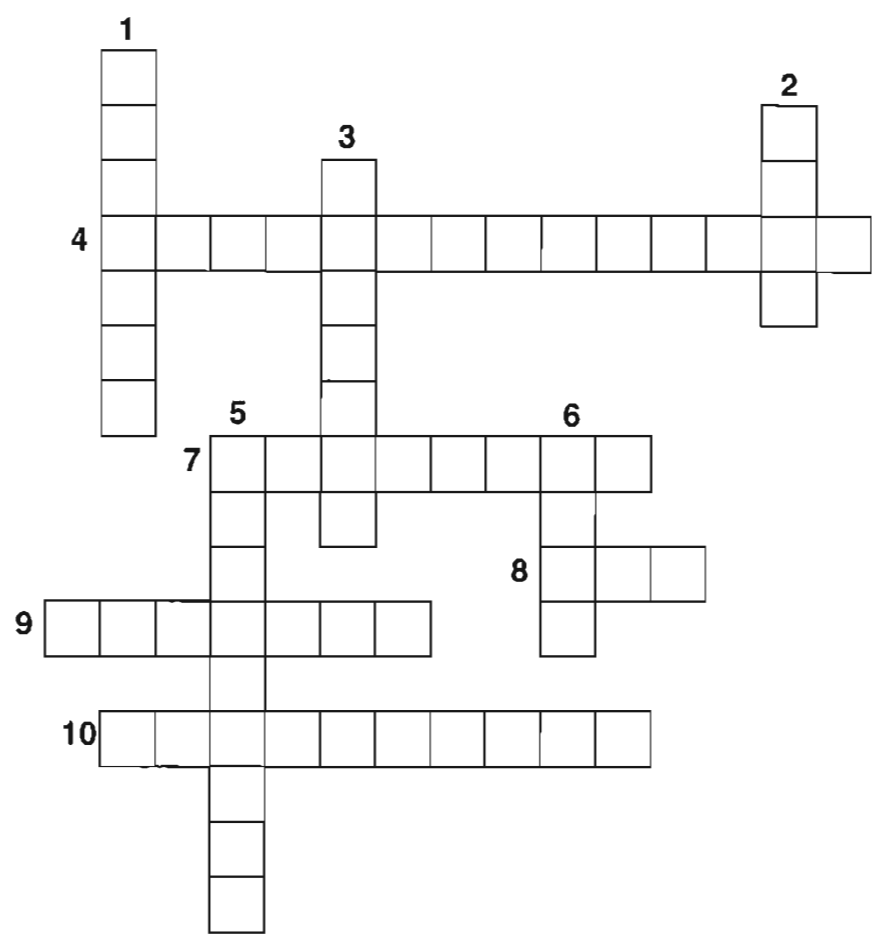
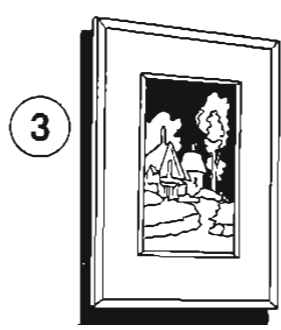
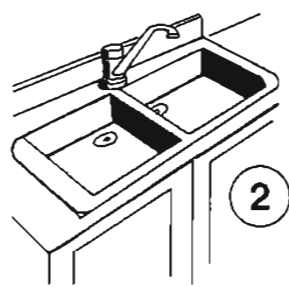
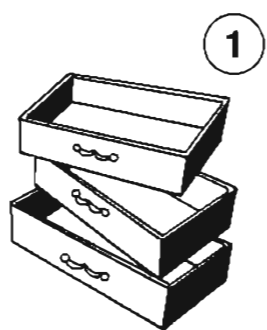

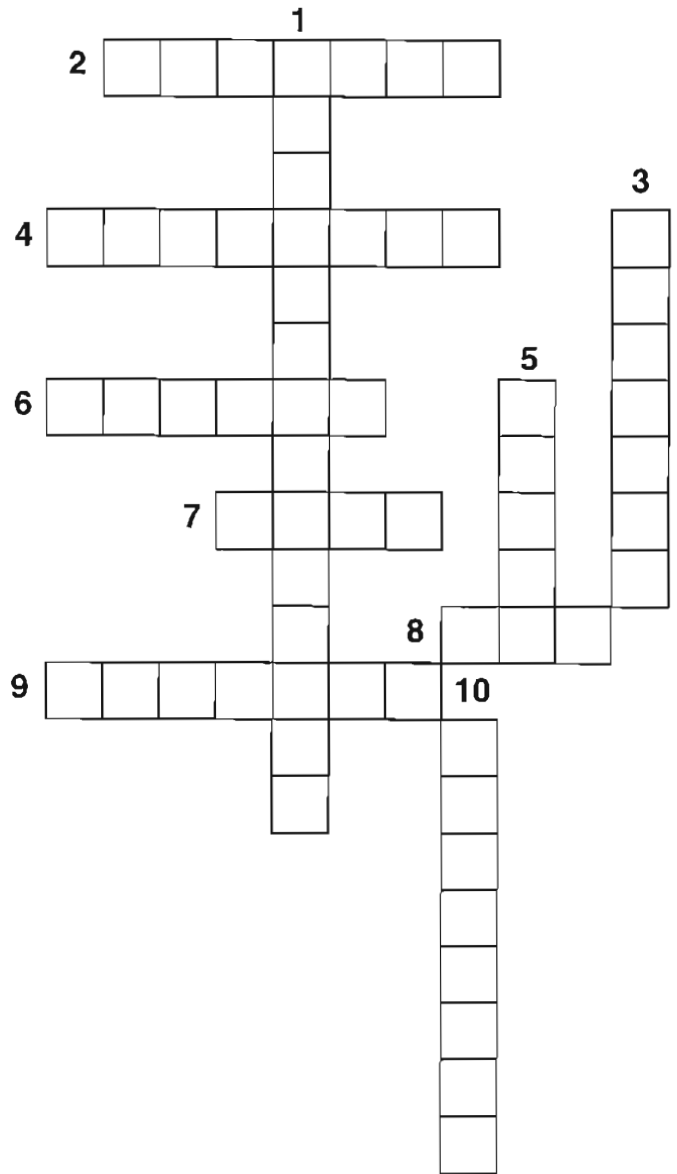
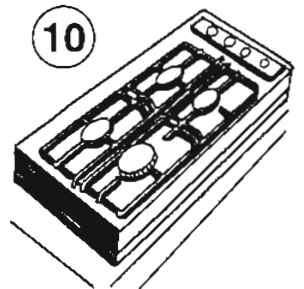
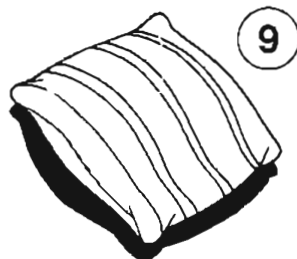
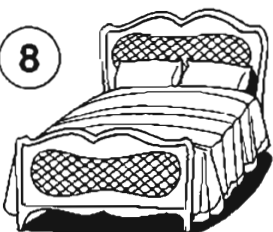
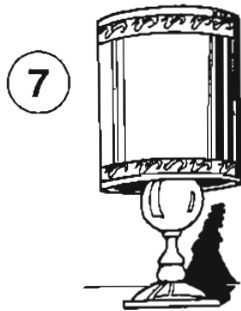
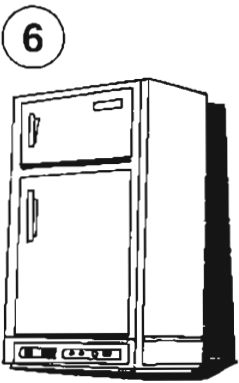
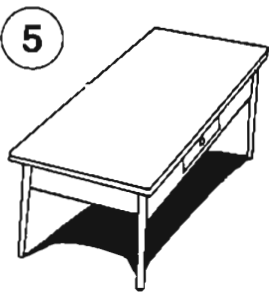
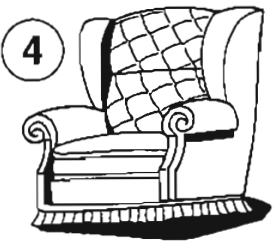
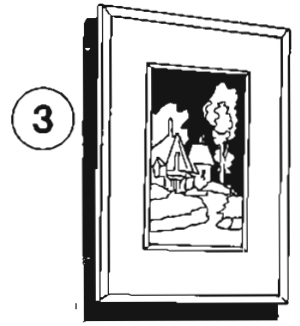
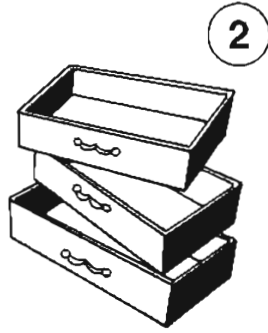
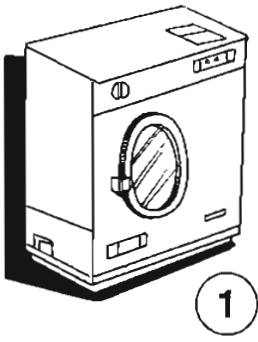

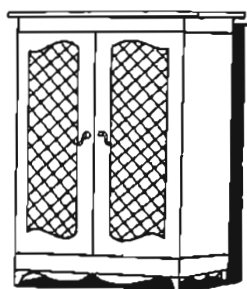

1



2

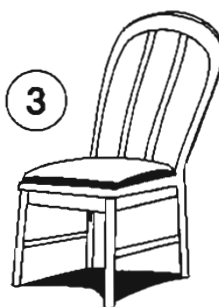

3

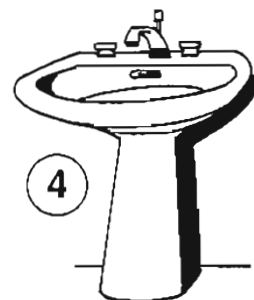

4

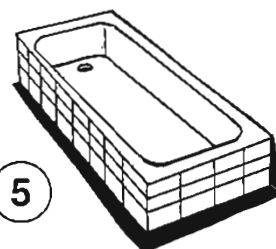
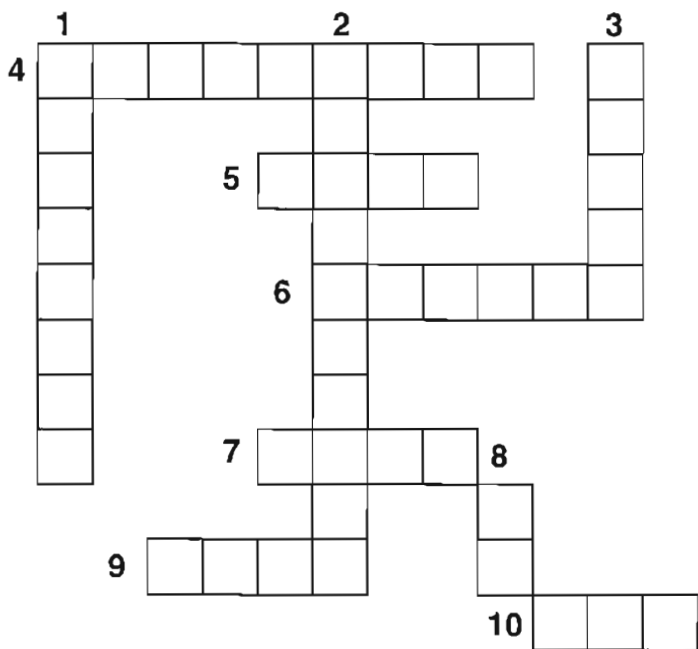

5

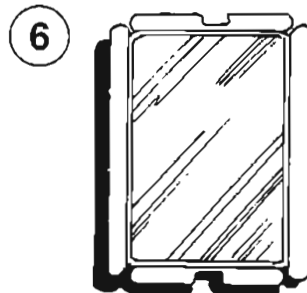

6

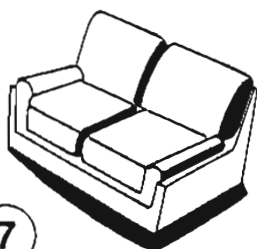

7

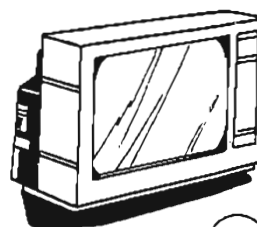

8

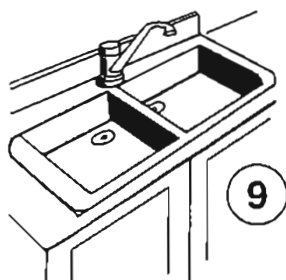

9

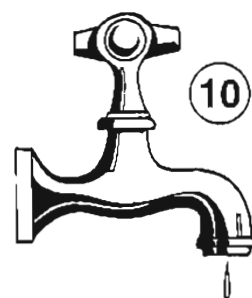

10

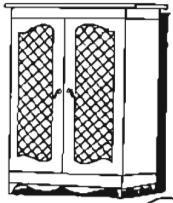

1

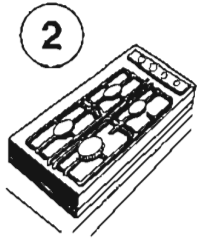

2

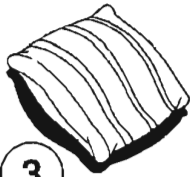

3

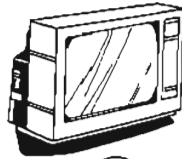

4



5



6

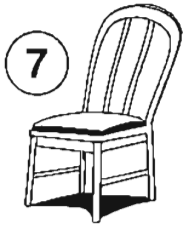

7



8

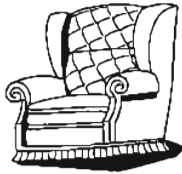

9



10

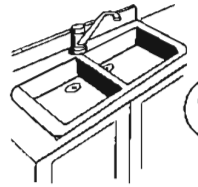

11

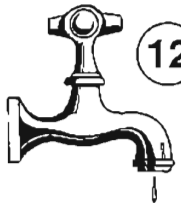

12

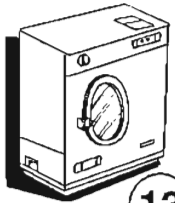

13



14



15

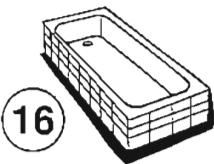

16

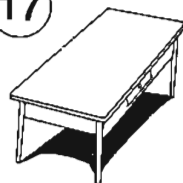

17



18



19

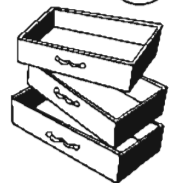

20

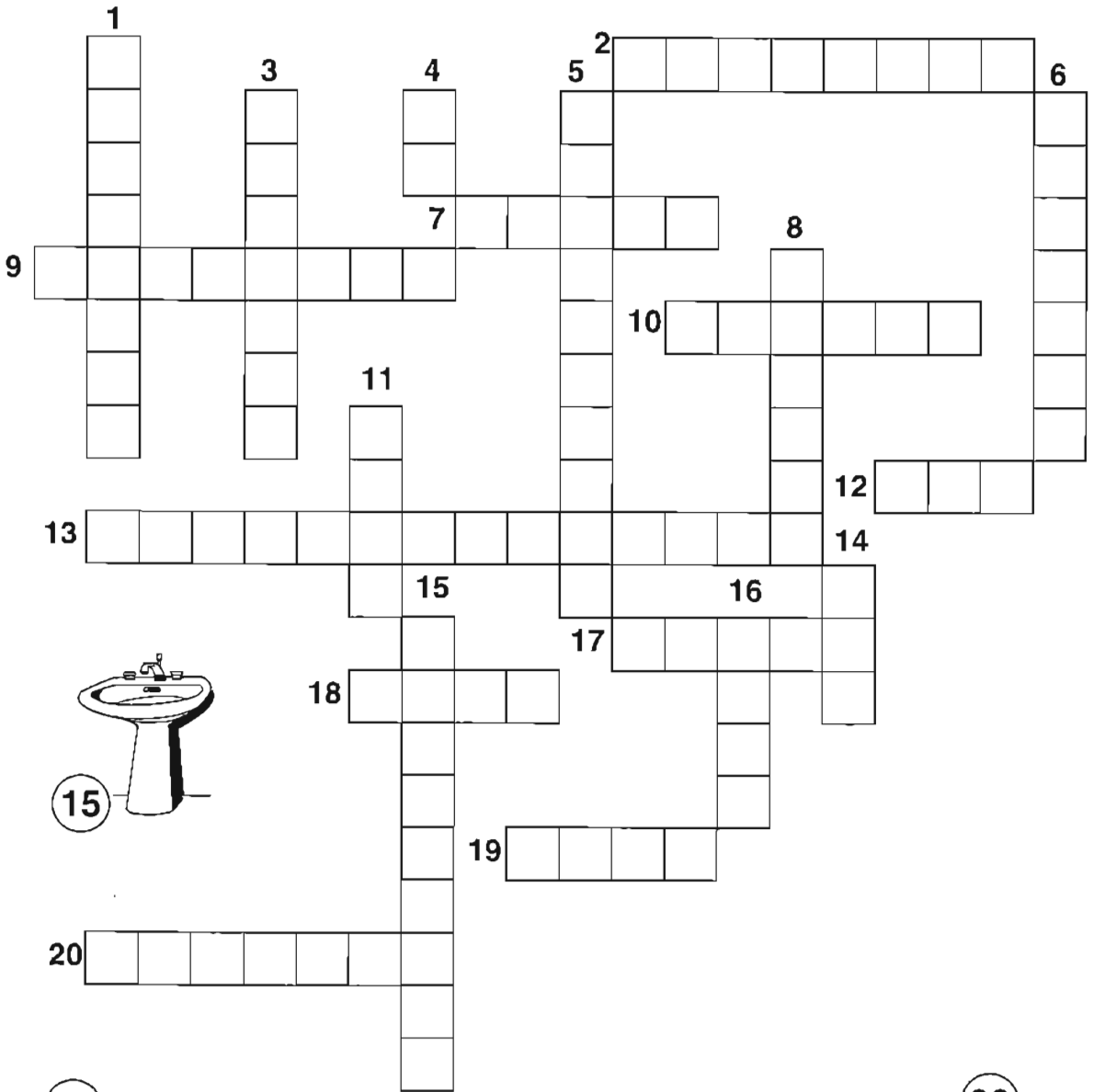



SPORTS



running



high jump



gymnastics



judo



riding



cycling



fencing



skating



swimming



canoeing



sailing



water skiing

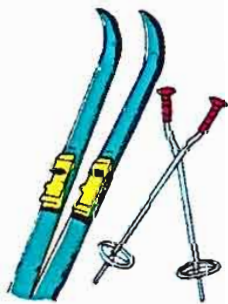

skiing



football

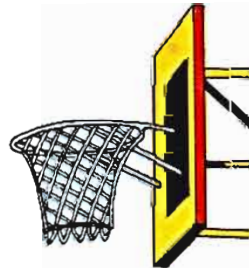

basketball

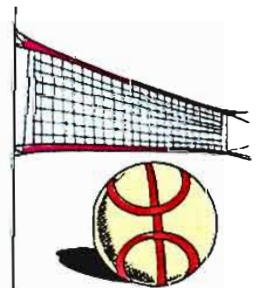

volleyball



baseball



tennis



golf



table tennis

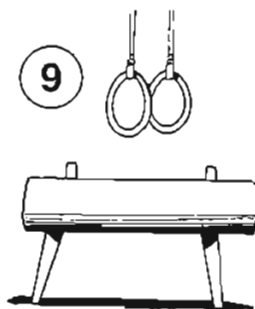
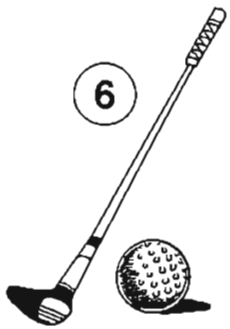
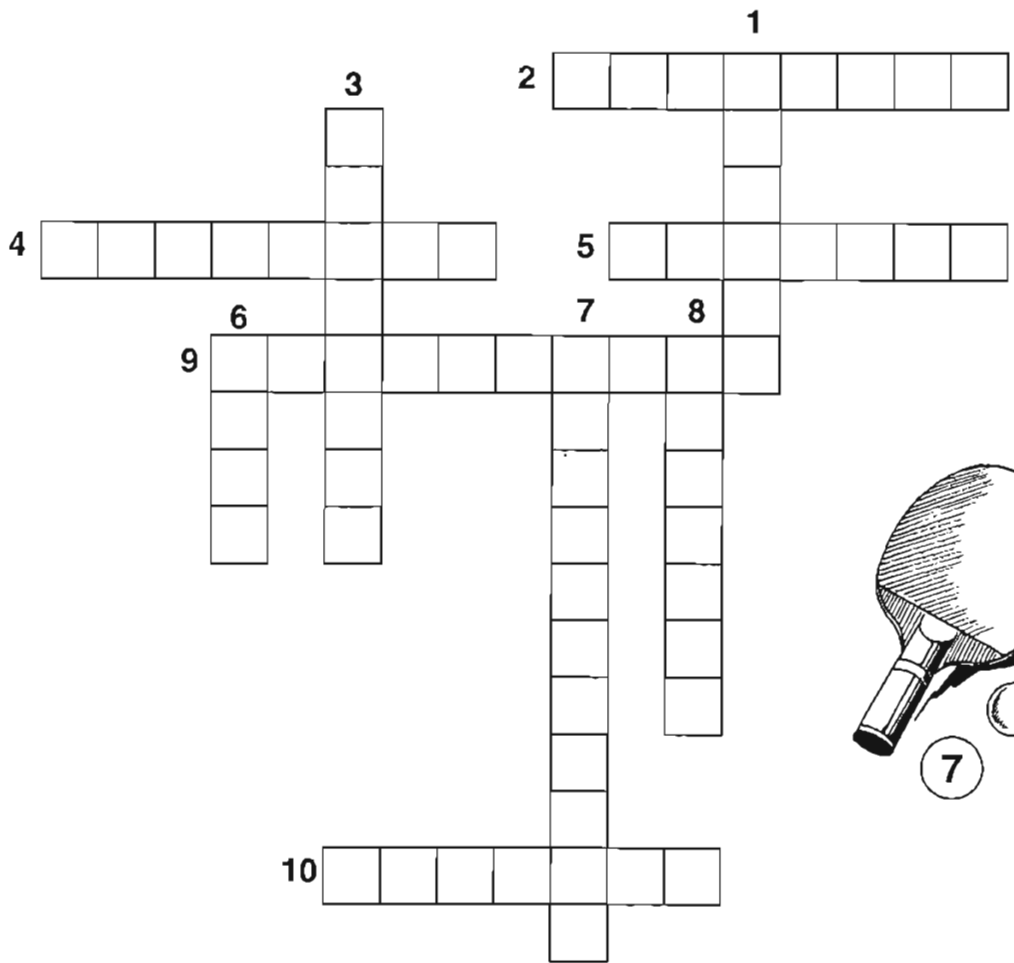
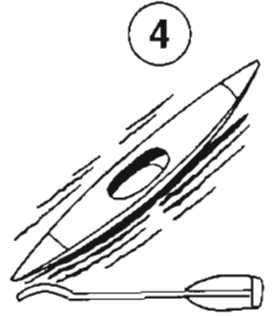
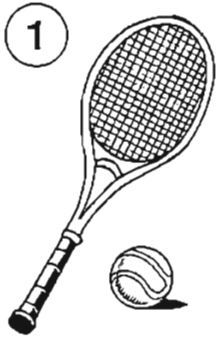

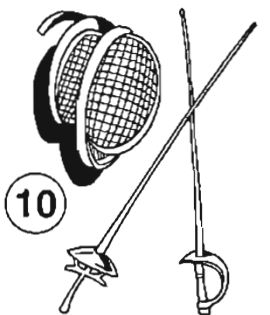
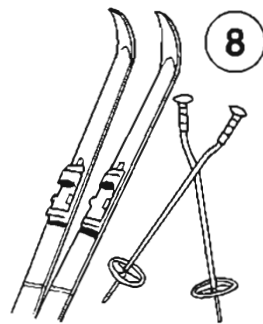
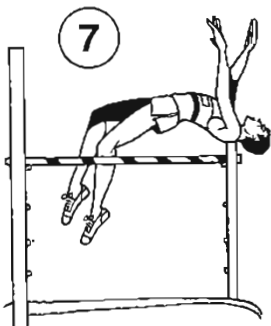
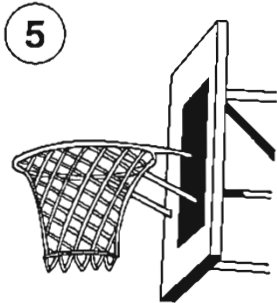
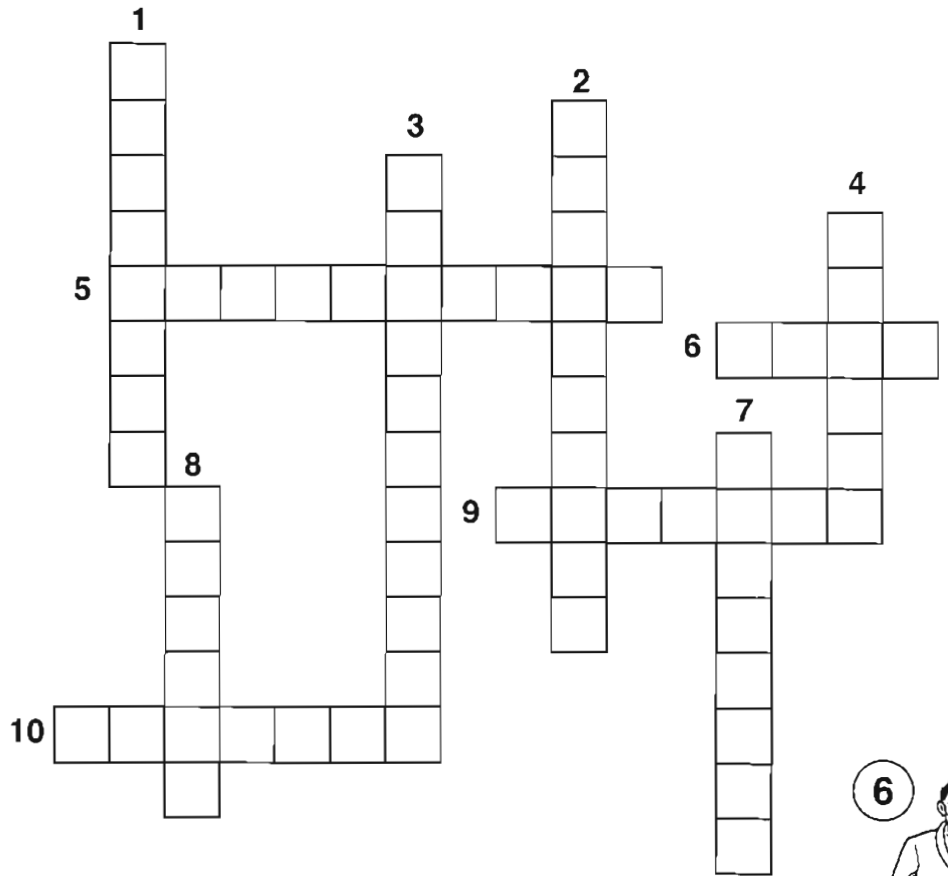
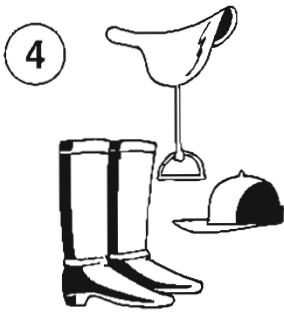
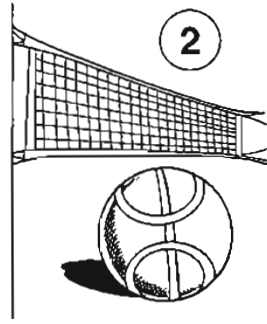
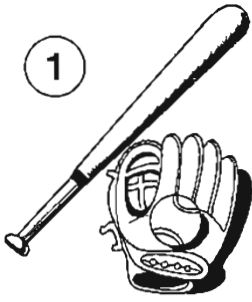

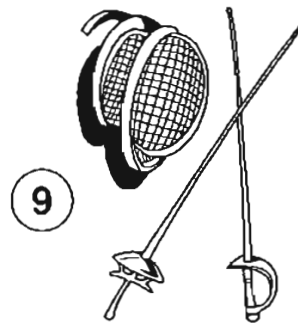
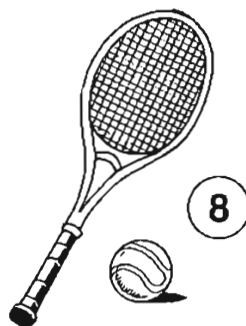
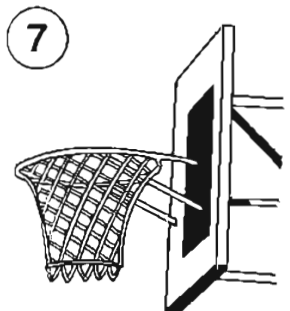
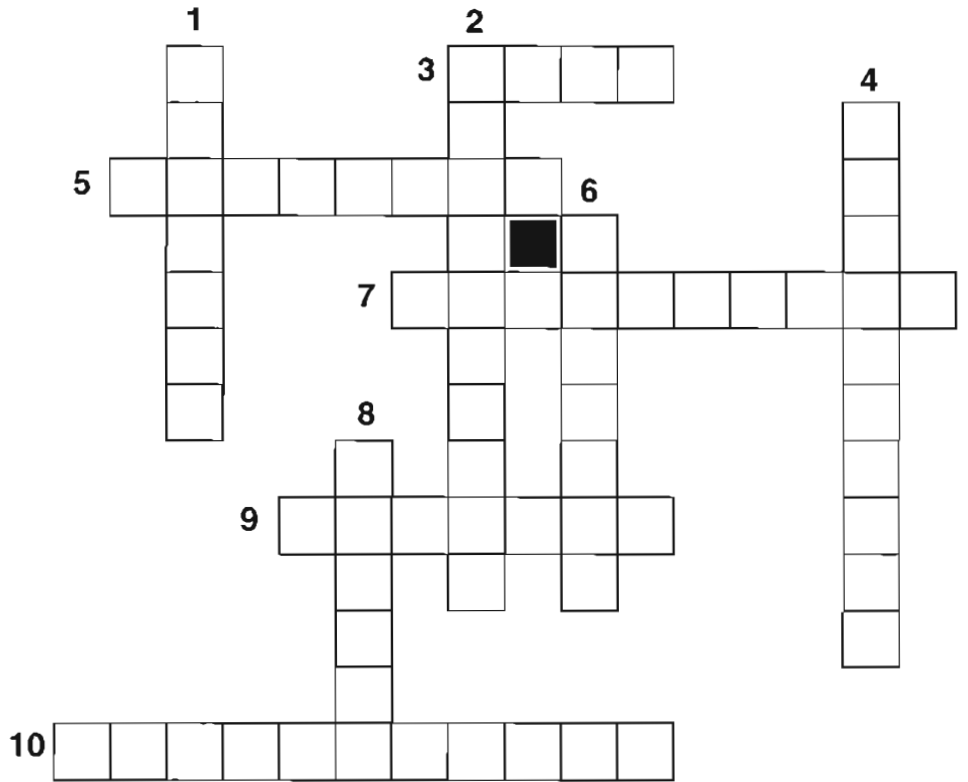
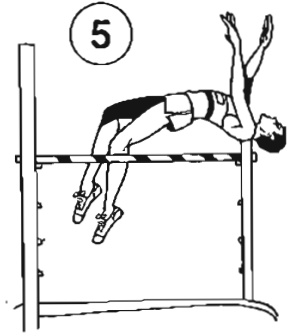
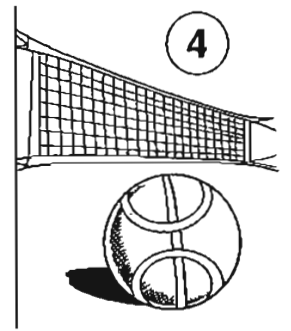
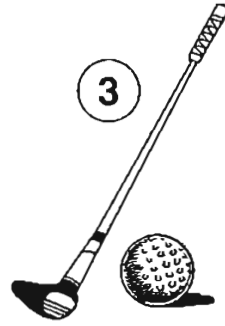
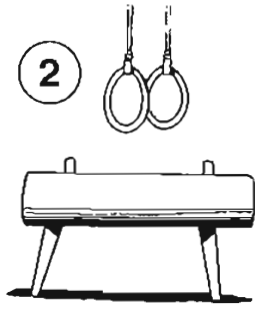



1



2



3



4

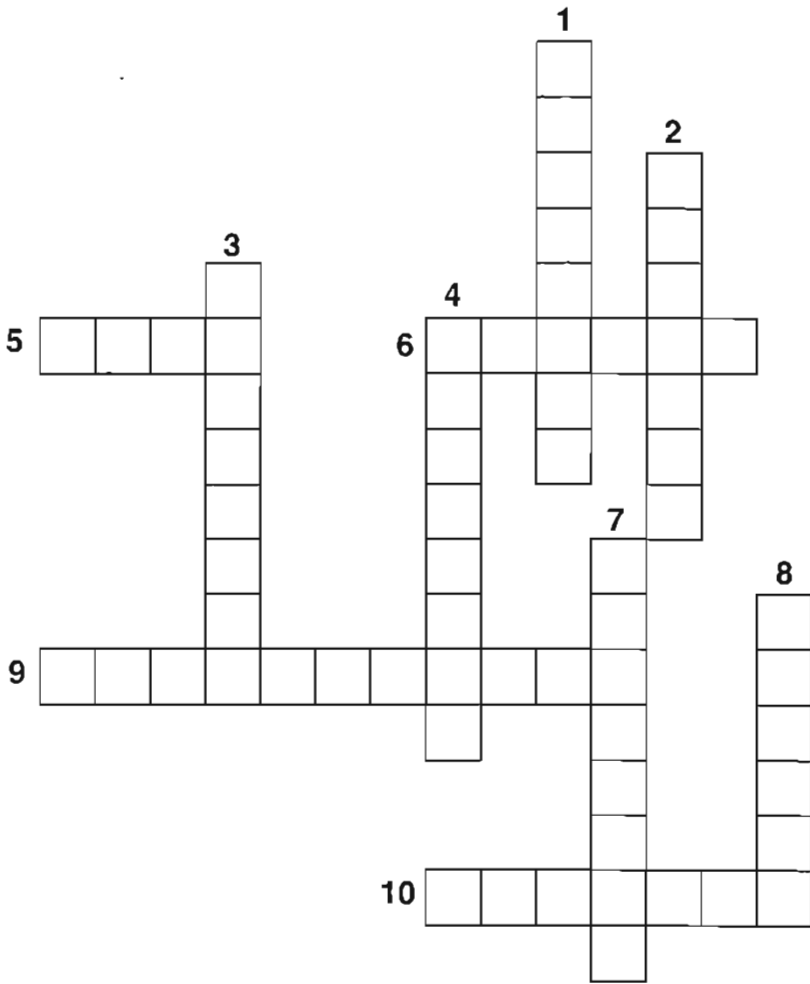

5



7



6

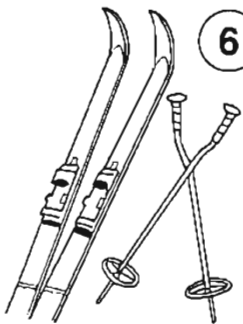

8



9

10



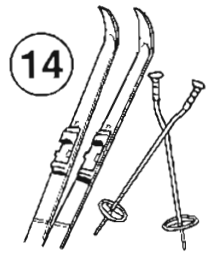
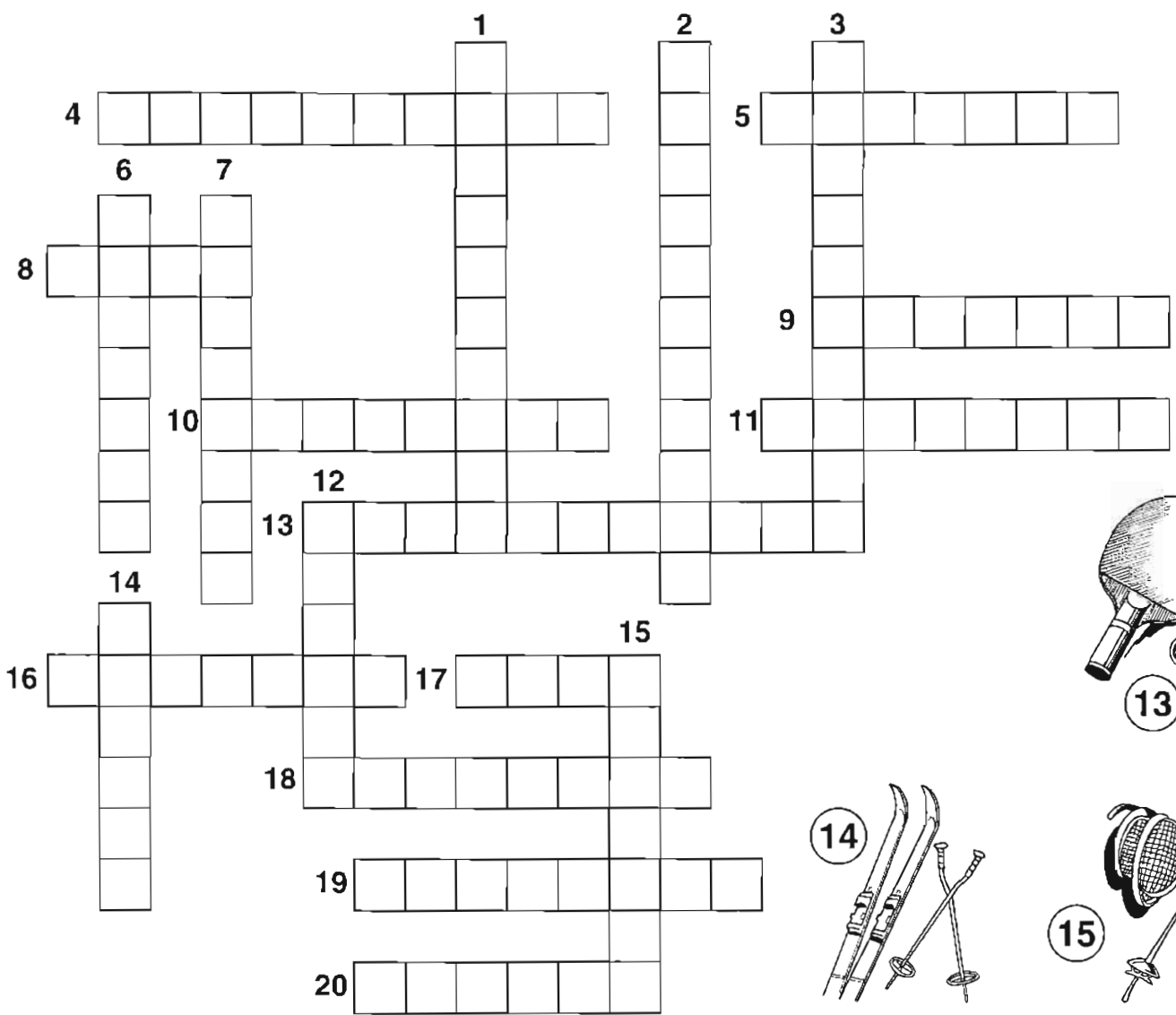
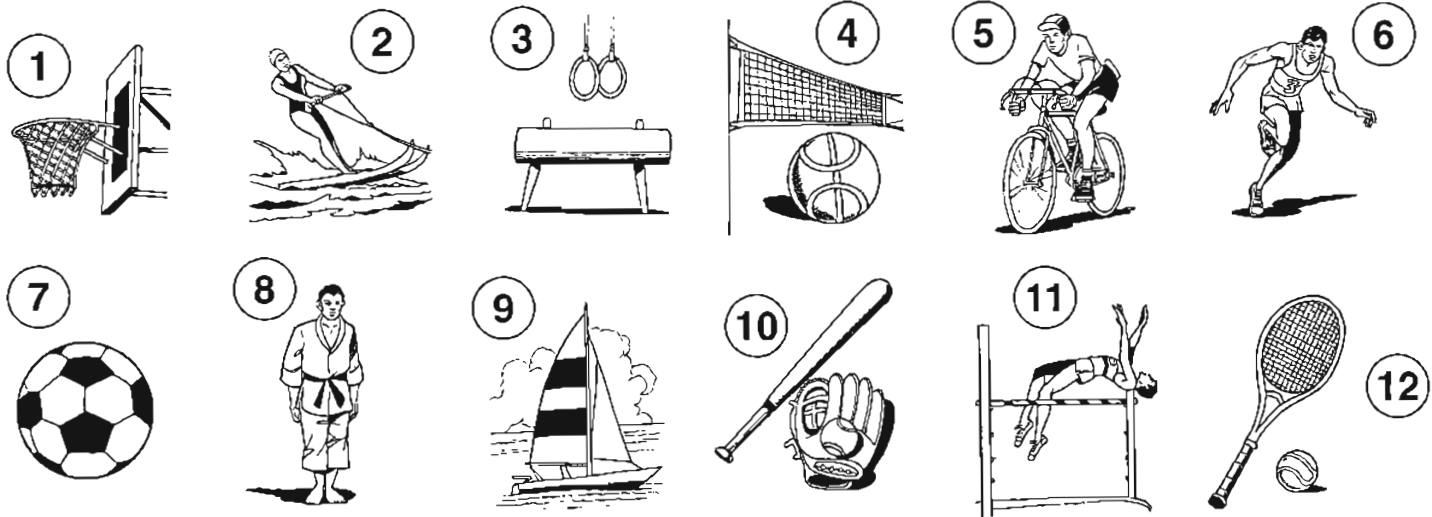



FOOD AND DRINK



coffee



tea

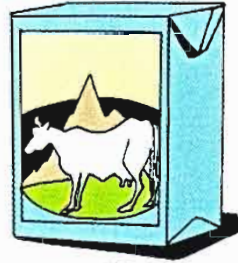

milk

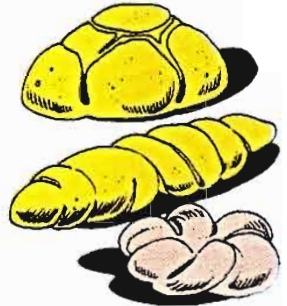

bread



biscuits



meat



fish

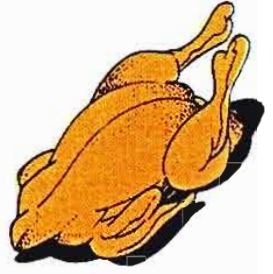

chicken

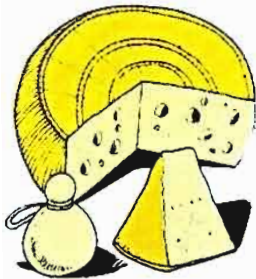

cheese

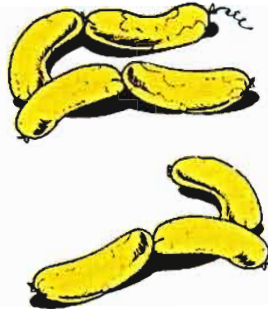

sausages

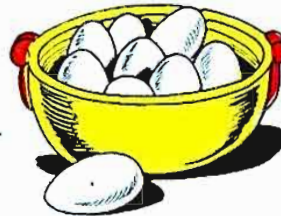

eggs



ham



ice cream



cake



water



sugar



soup



fruit juice



butter



jam

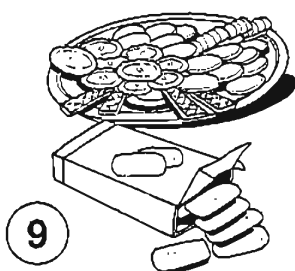
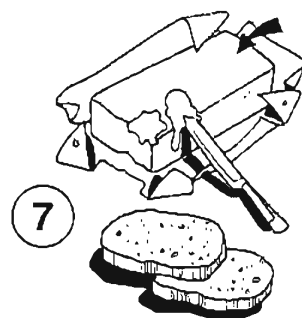
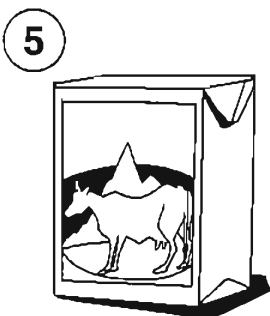
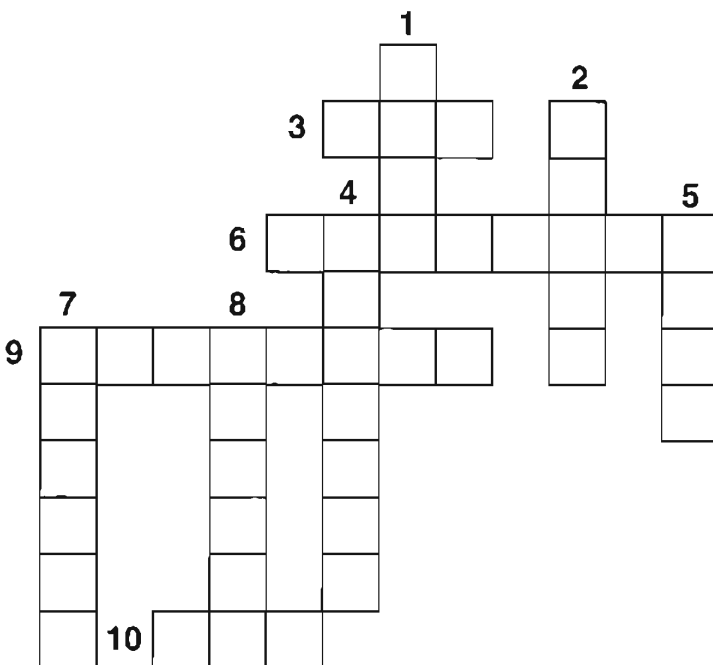
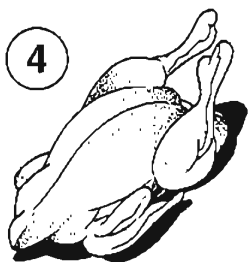
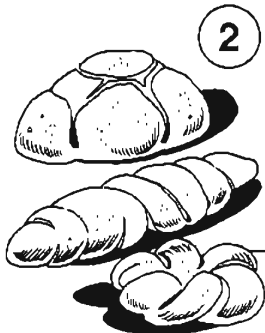
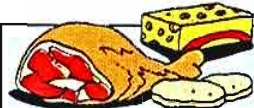

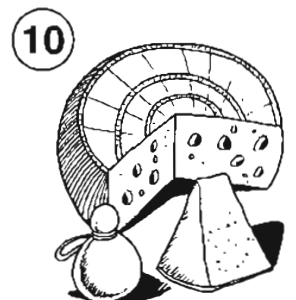
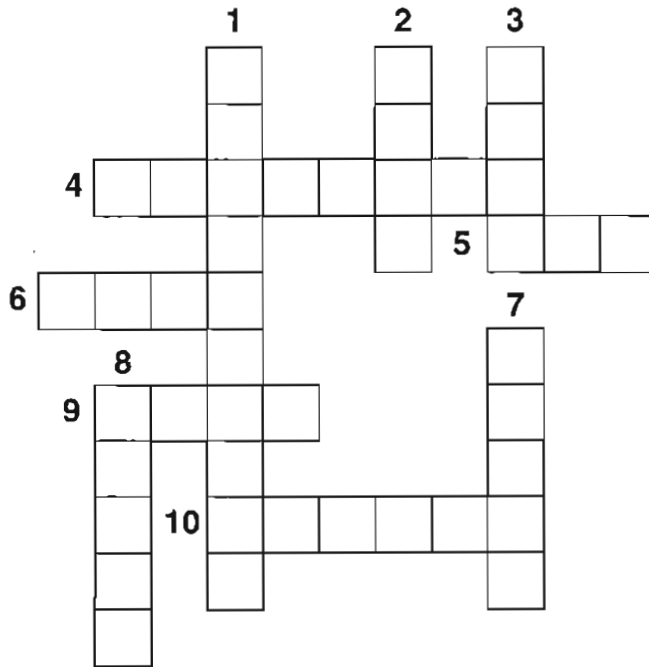
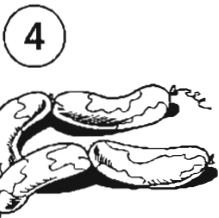
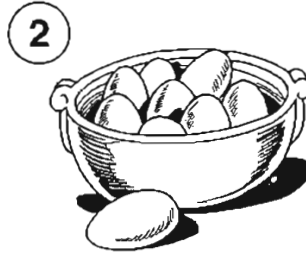
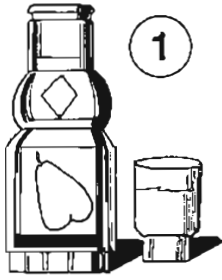

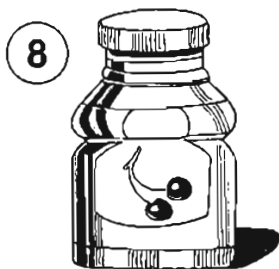
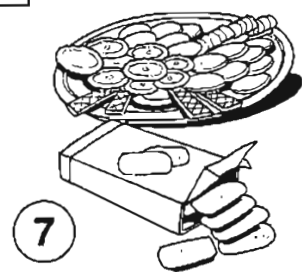
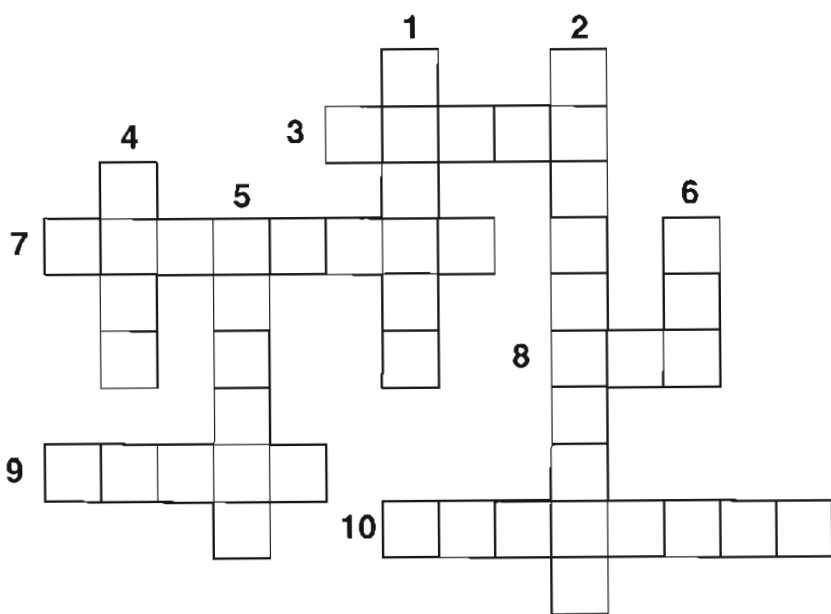
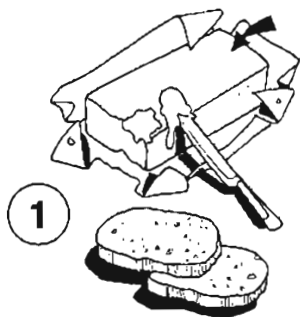

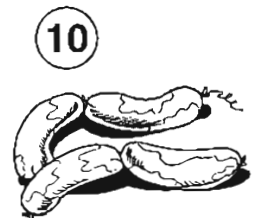
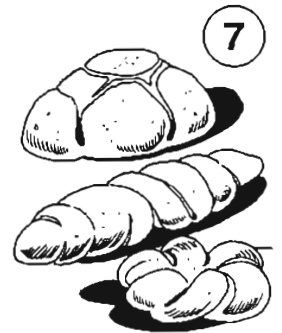
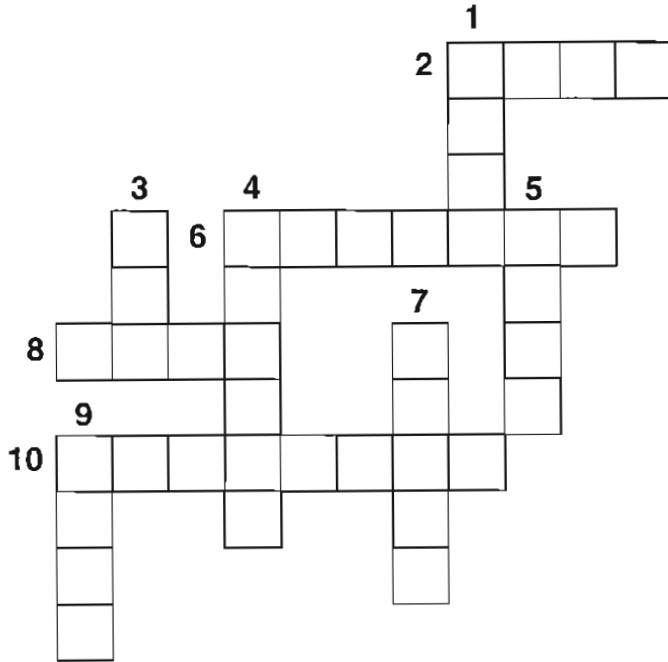
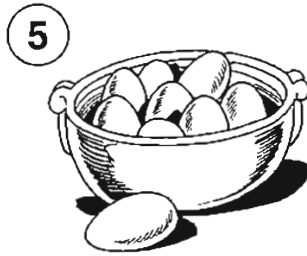
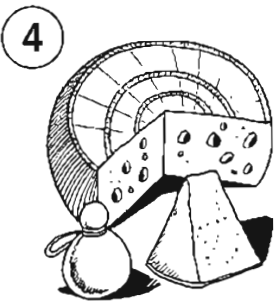
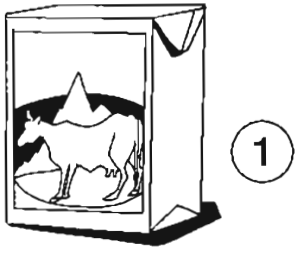

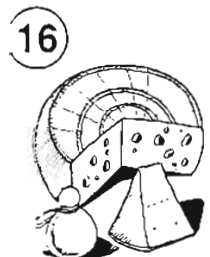
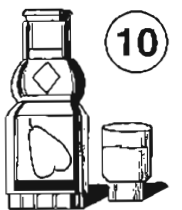
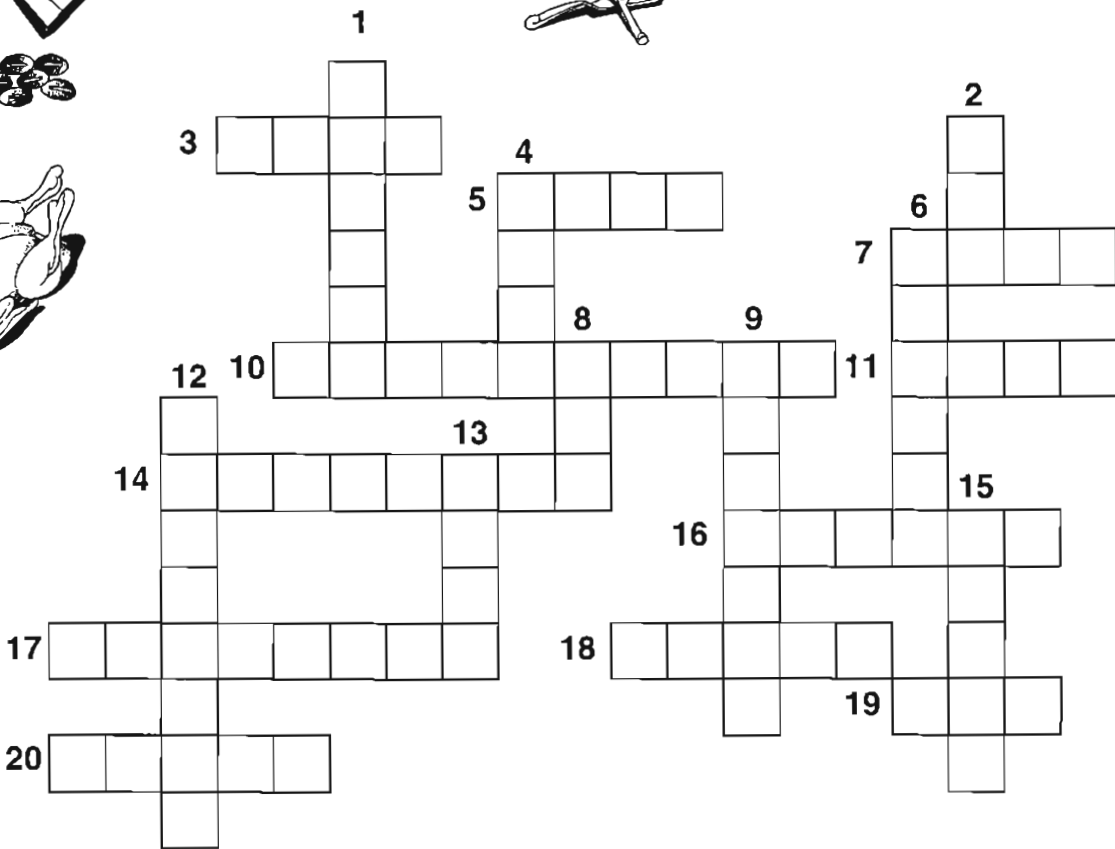
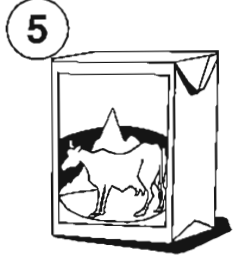



FRUIT AND VEGETABLES



apple

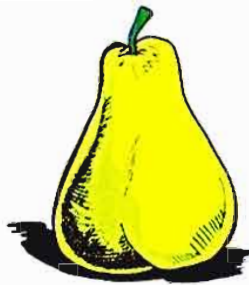

pear



grapes



strawberries

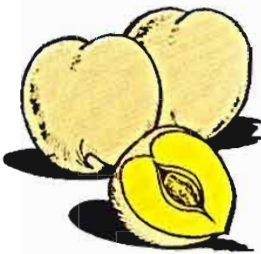

peaches

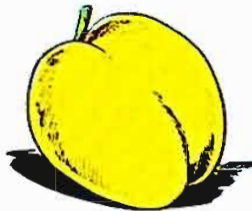

apricot

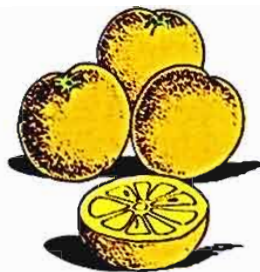

oranges

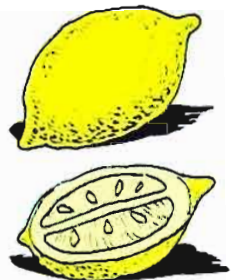

lemon

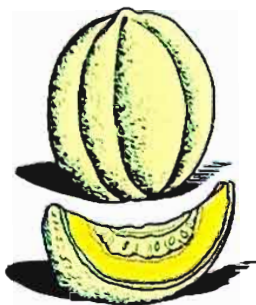

melon

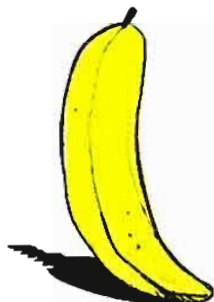

banana



pineapple

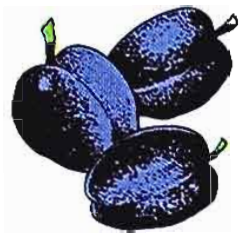

plums



cherries



cabbage

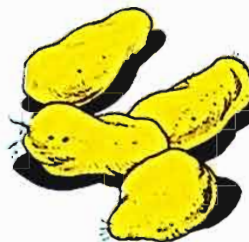

potatoes



tomatoes



lettuce



carrots



peas



mushroom

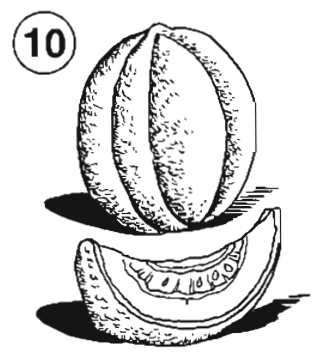
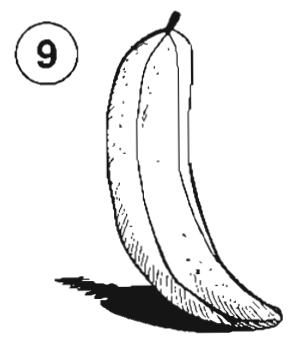
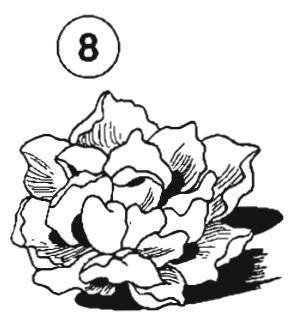
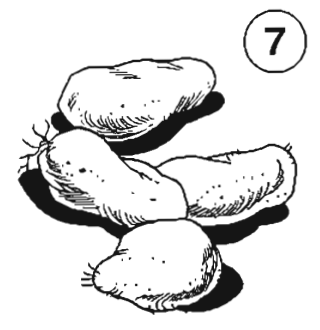
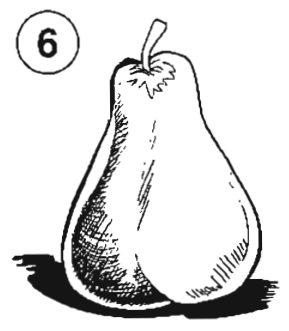
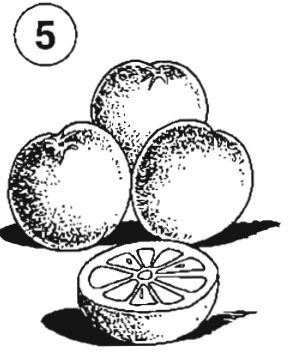
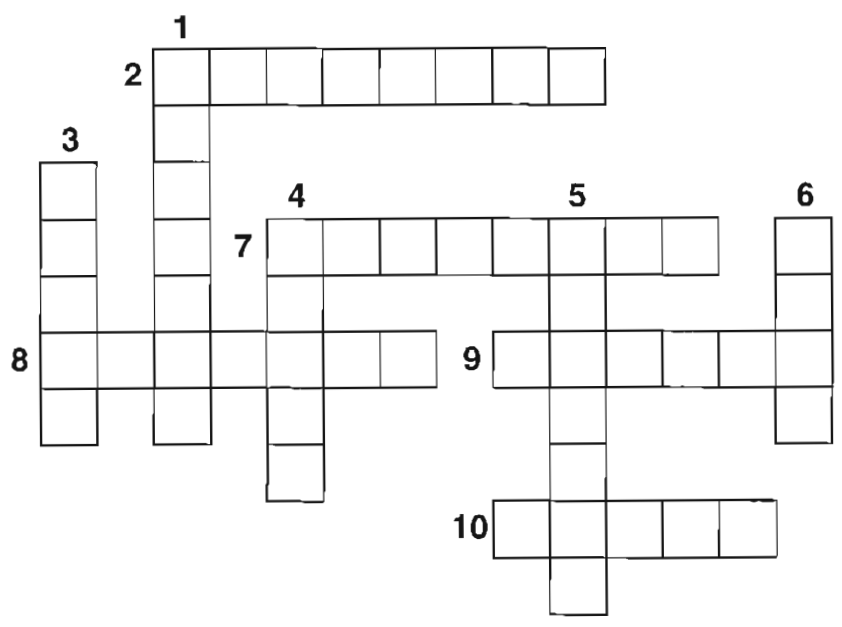
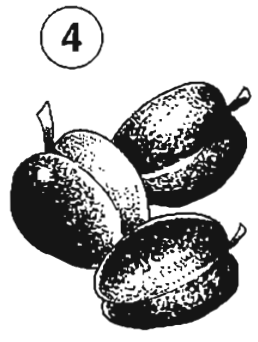
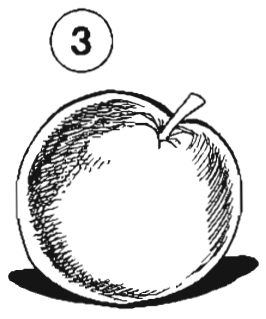
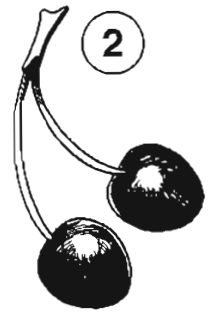
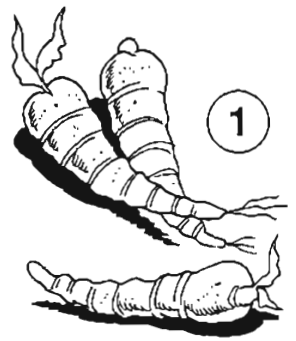
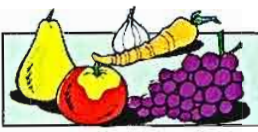

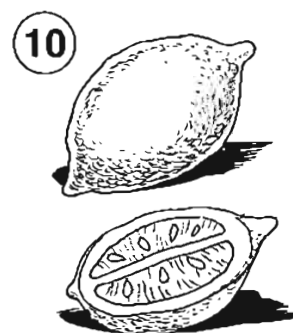
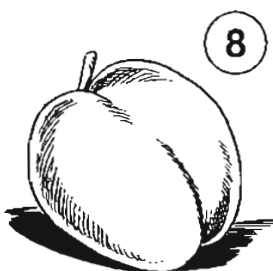
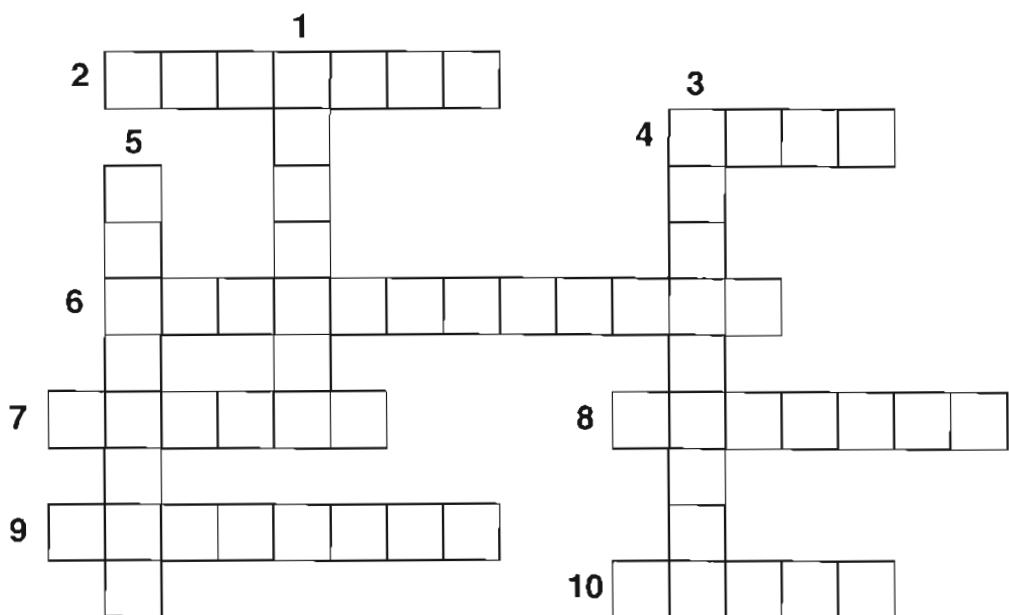
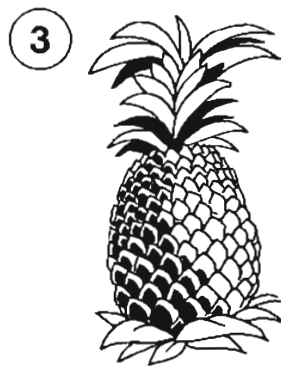
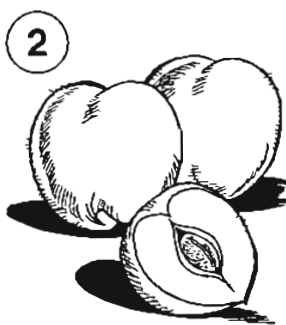
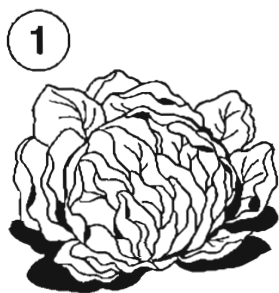

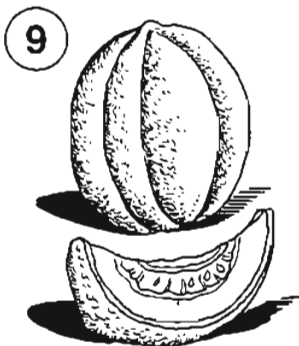
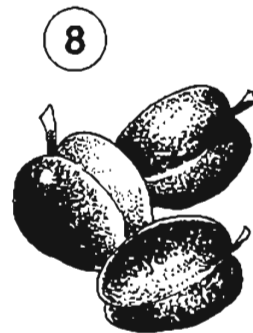
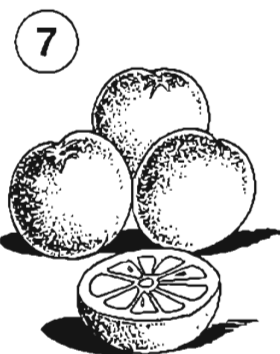
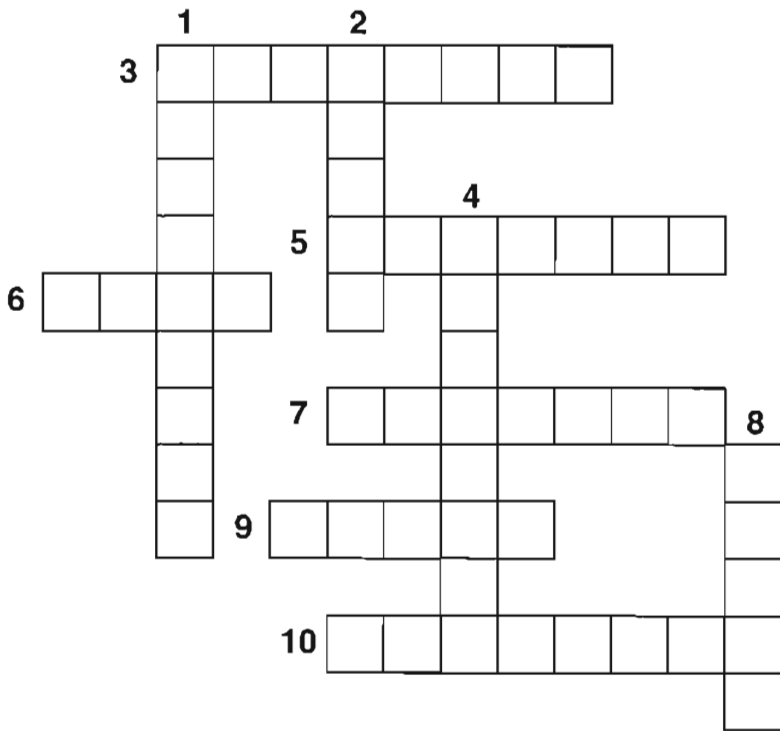
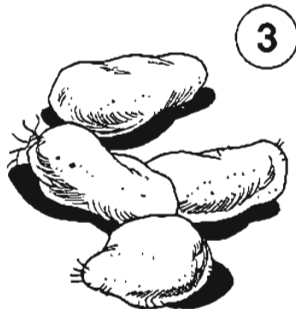
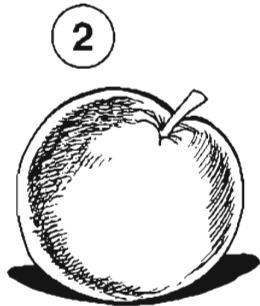
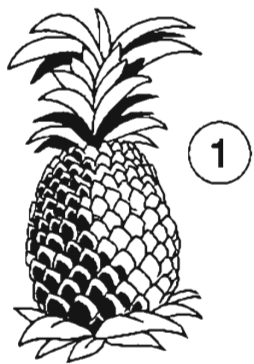

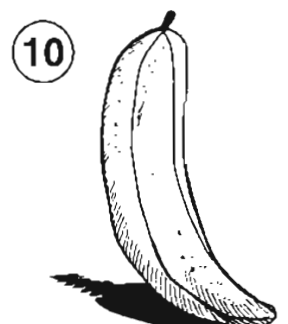
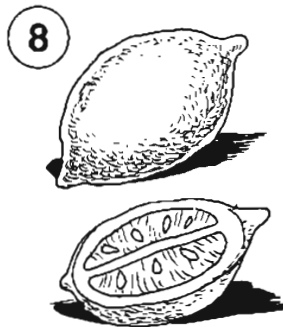
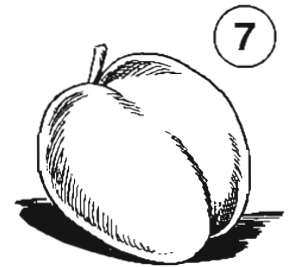
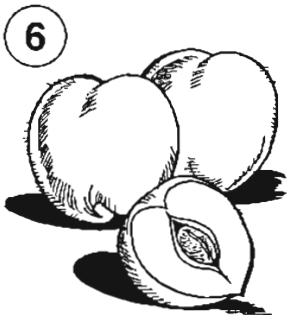
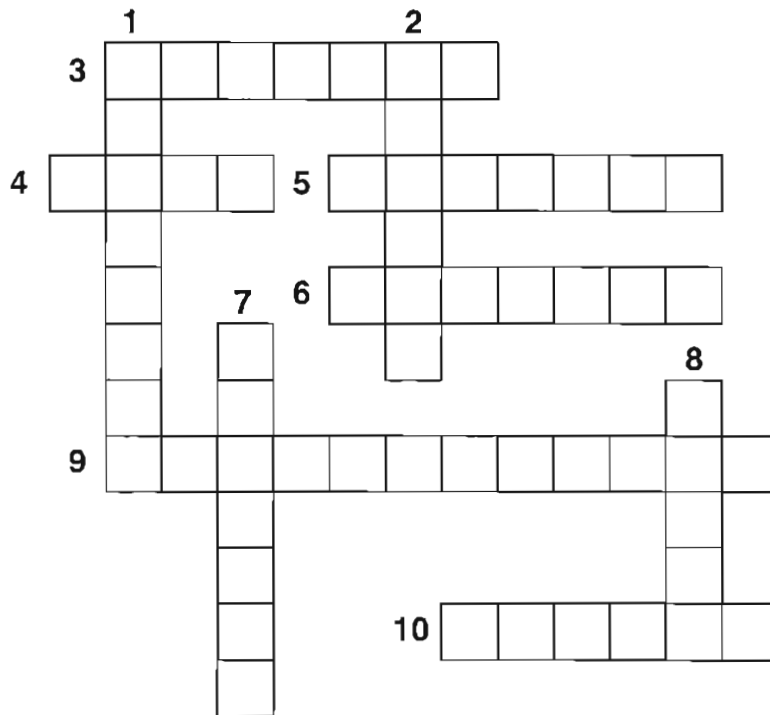
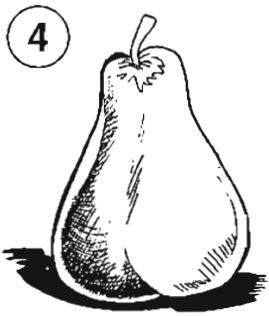
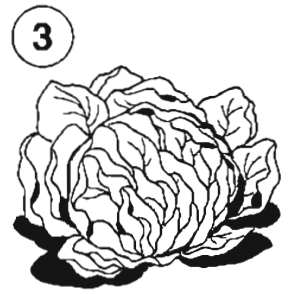
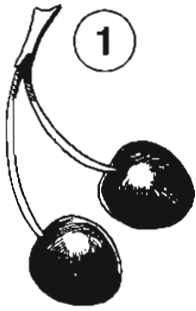

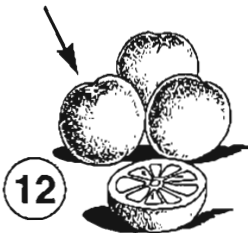
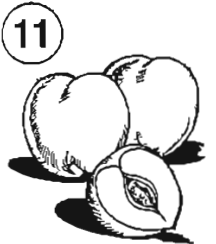
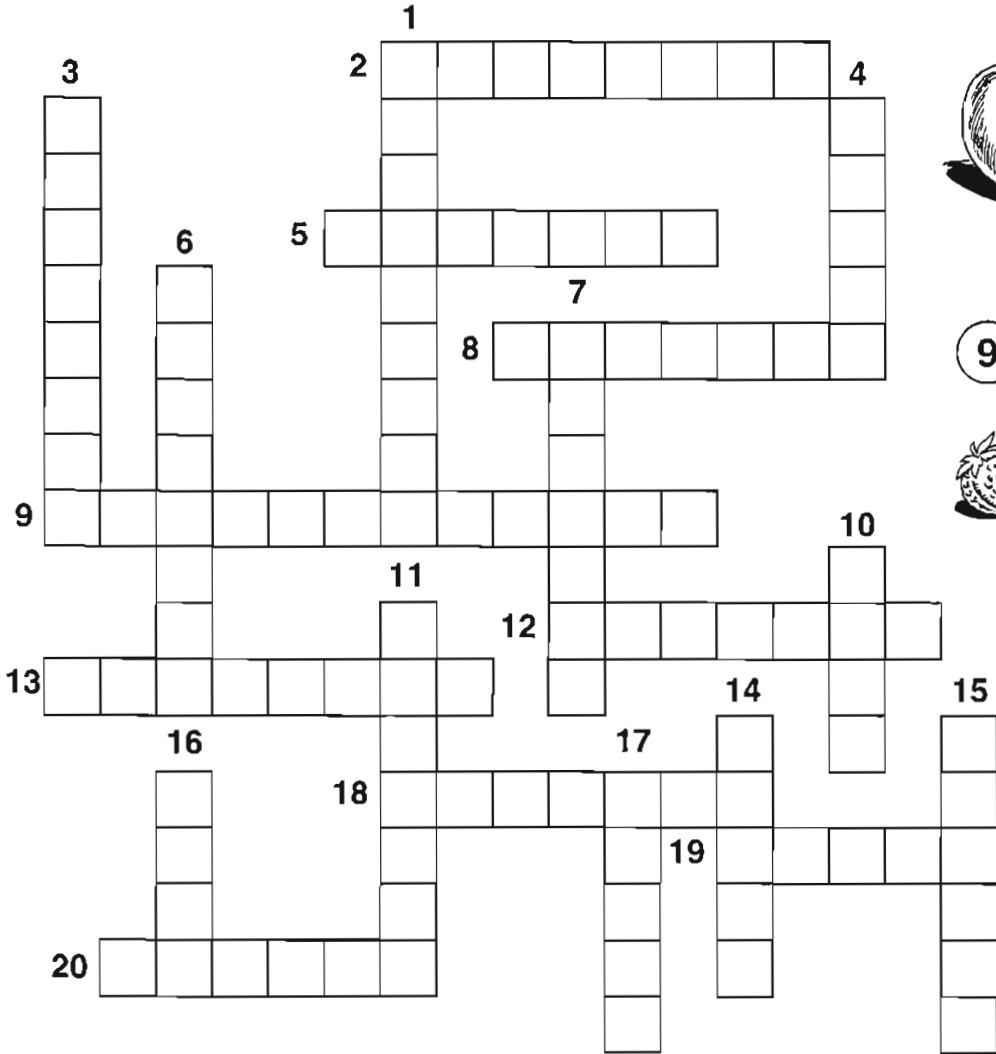
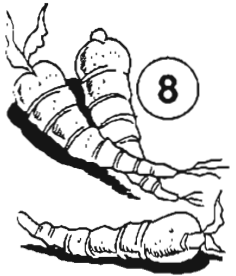
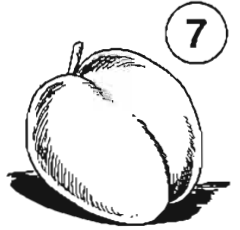
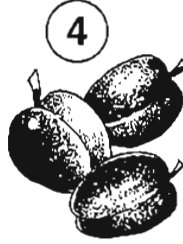
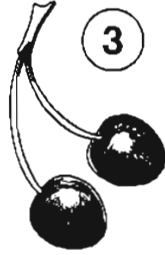
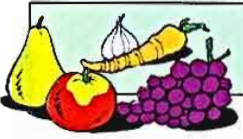



NATURE



tree



flower



mountains



hill

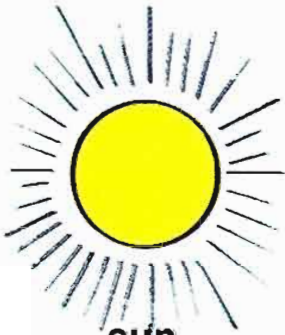

sun



clouds



stars



moon



rainbow



sky



field



wood



waterfall



river



sea



lake



island



snow



rain



wind

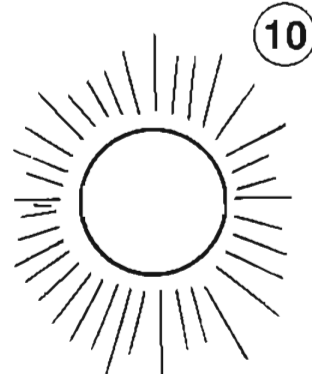
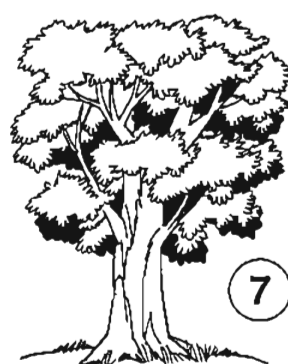
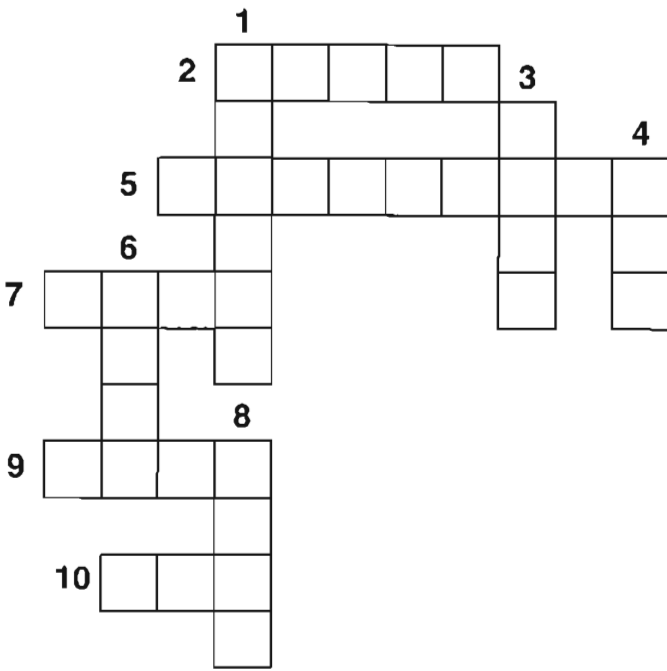
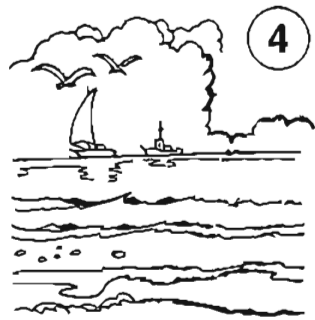
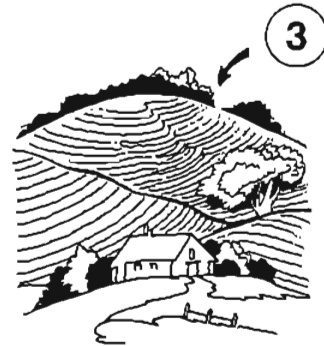

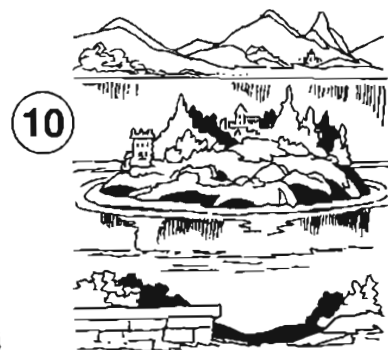
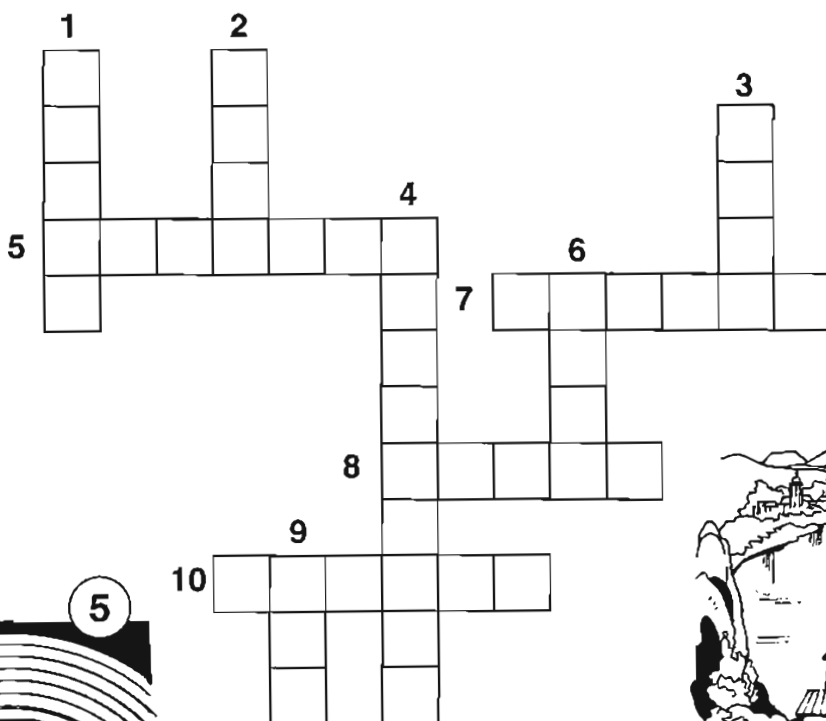
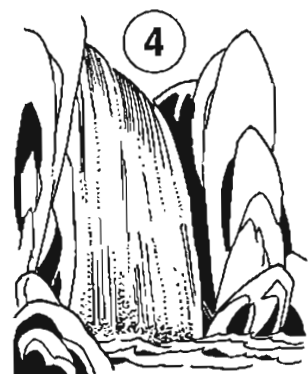
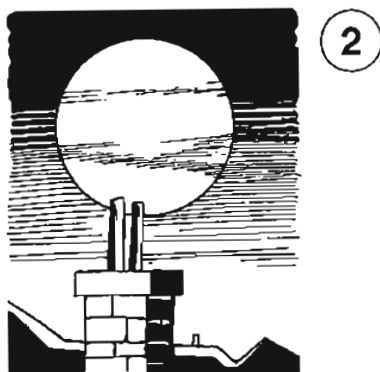

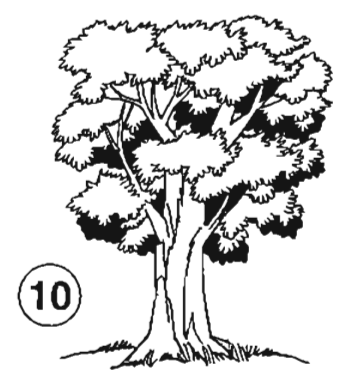
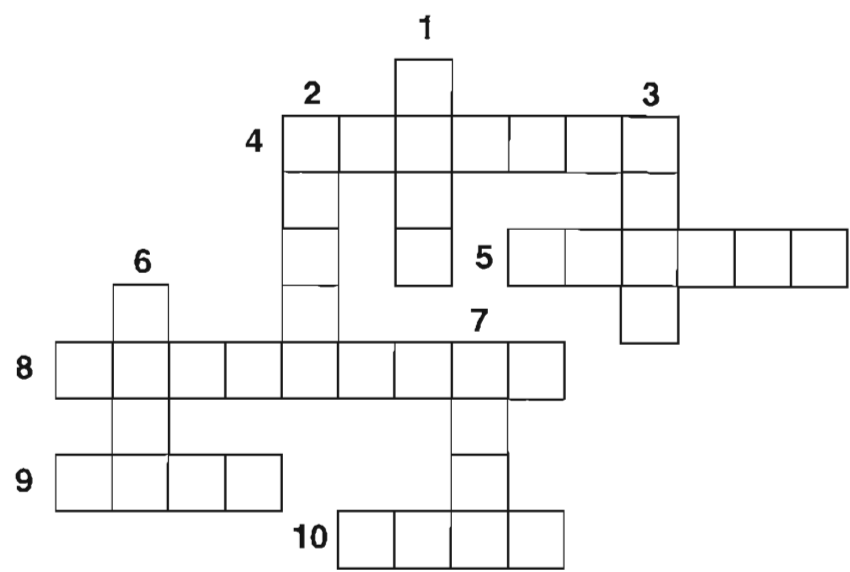
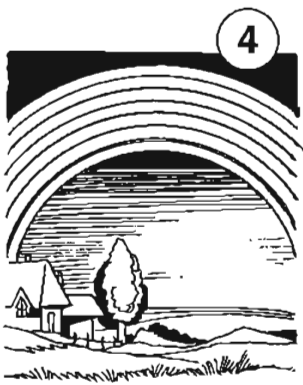
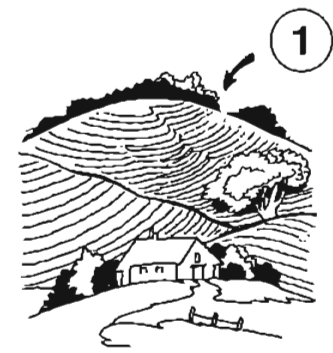

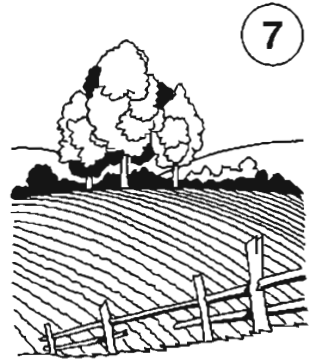
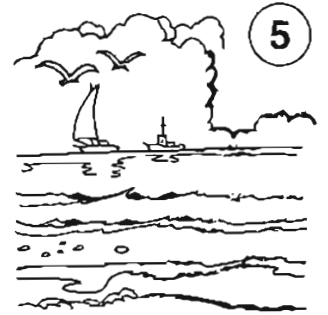
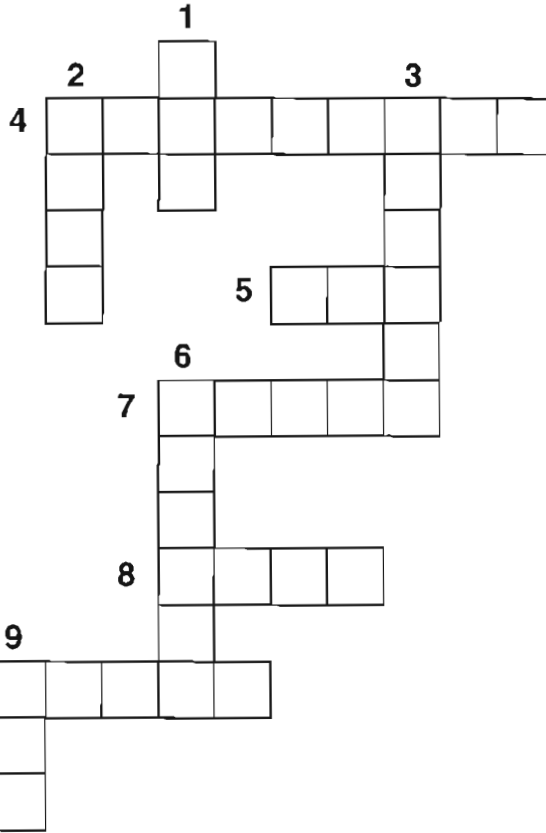
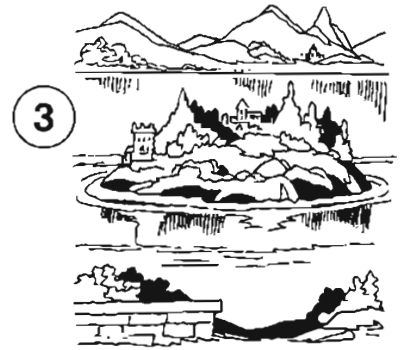
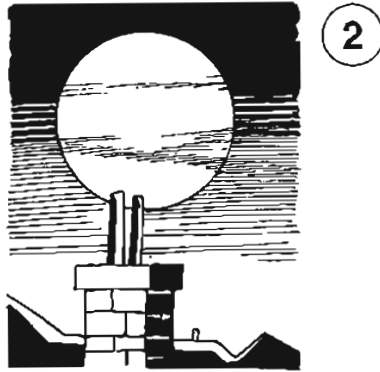
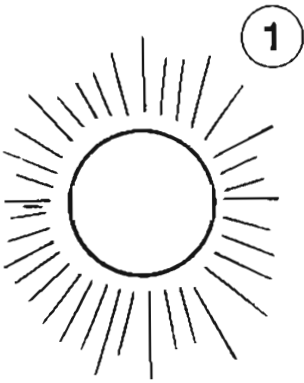



1



2



3

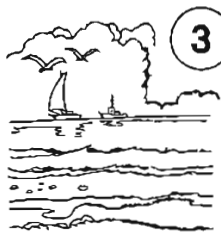

4



5



6

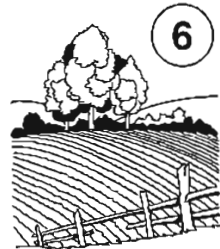

7

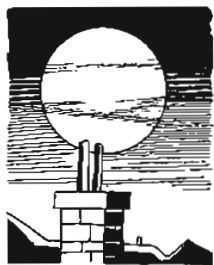

8



9



10

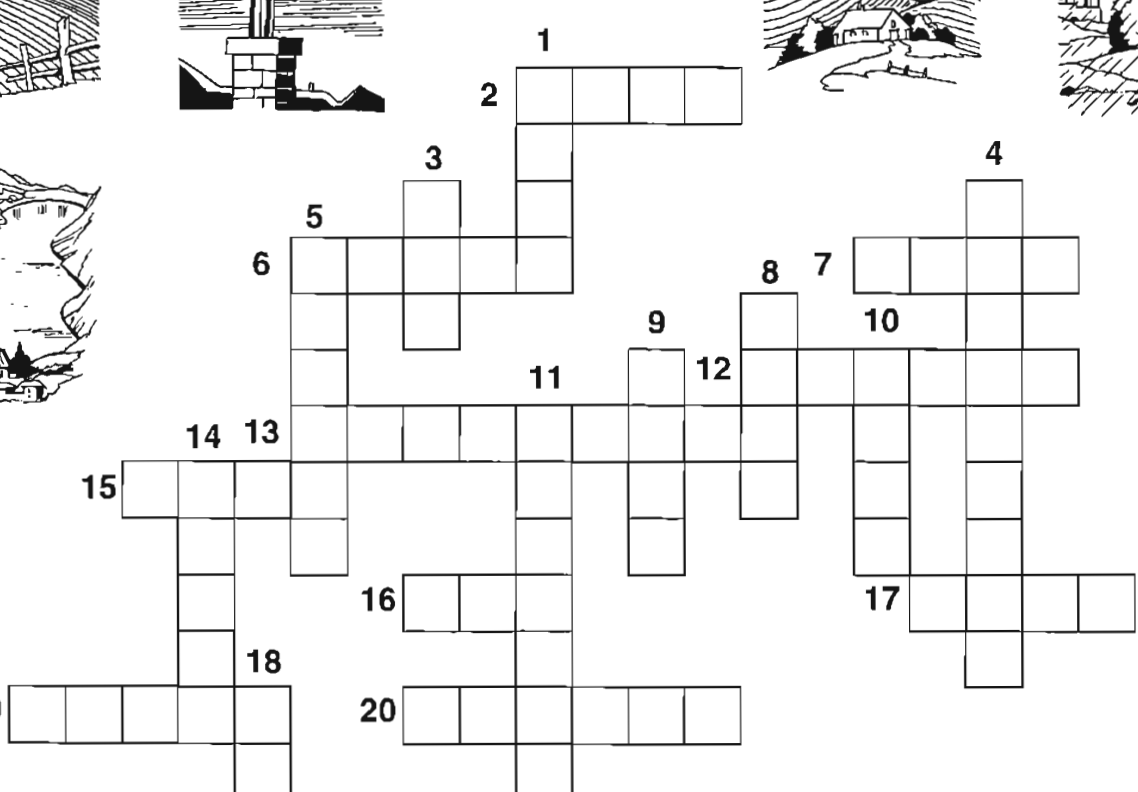

11



12

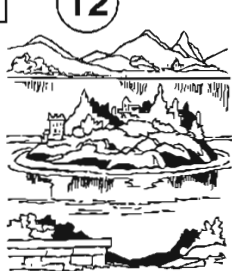

13



14



15



16

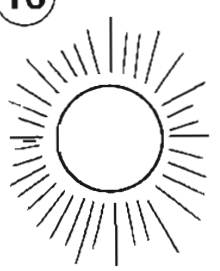

17



18



19



20



IN TOWN



school



church

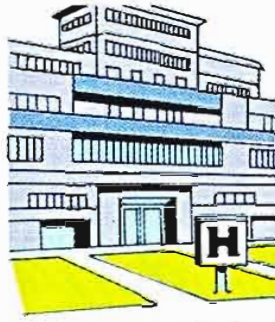

hospital



library



shops



bank



post office



cinema



hotel



restaurant



petrol station



factory



stadium



park

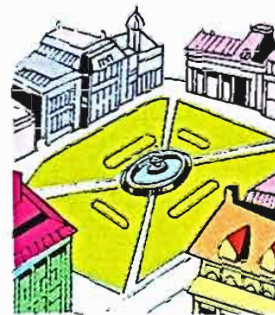

square



street

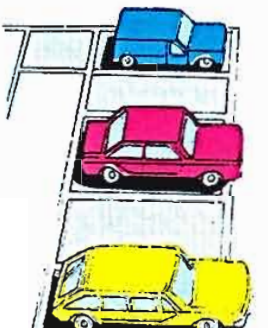

car park



traffic lights

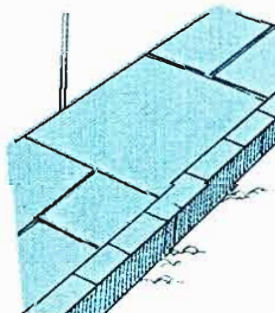

pavement



statue

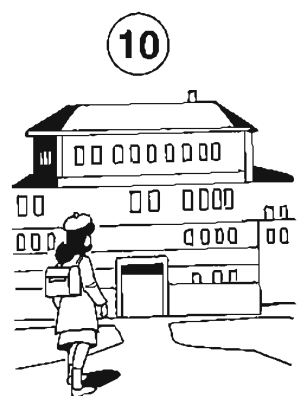
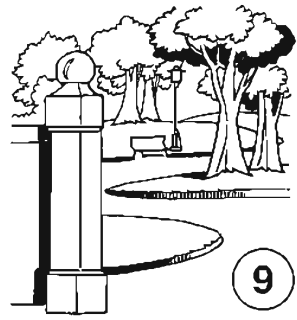
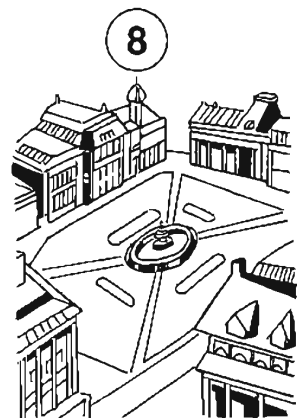
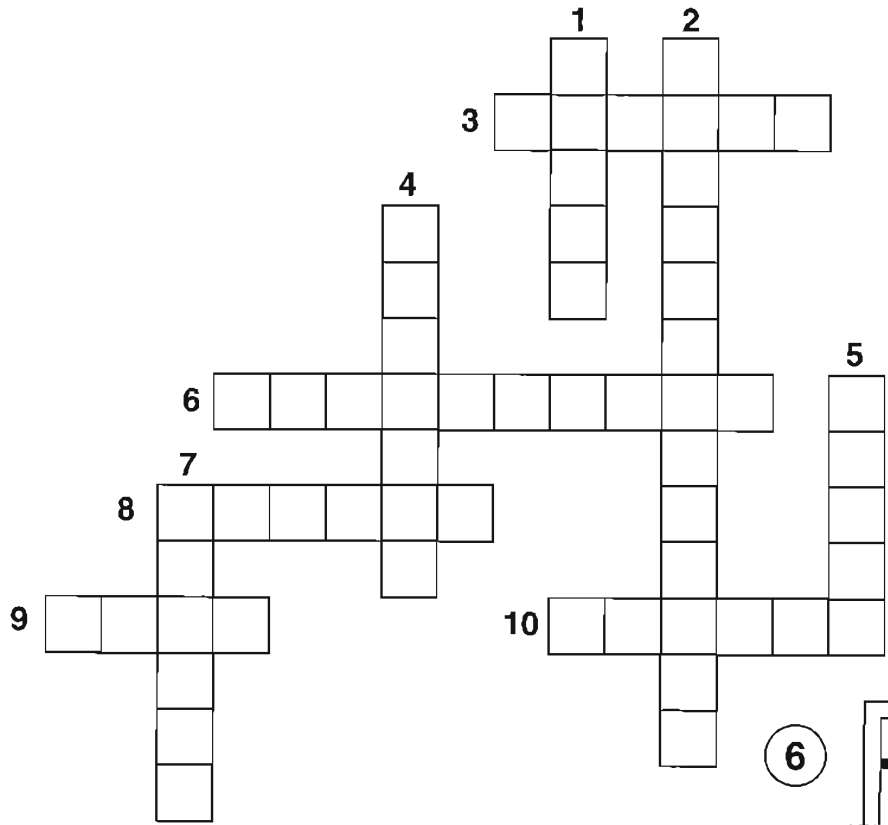
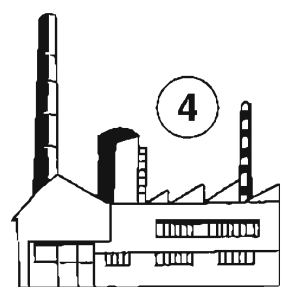
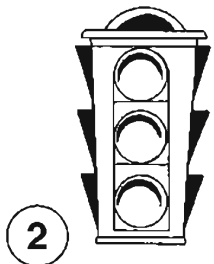
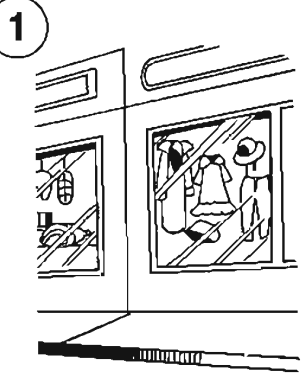
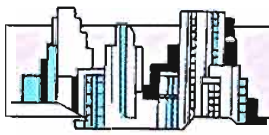

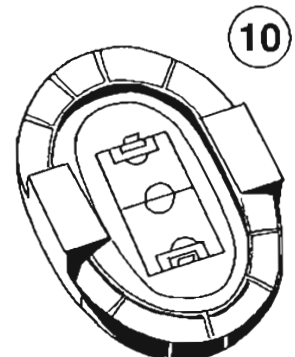
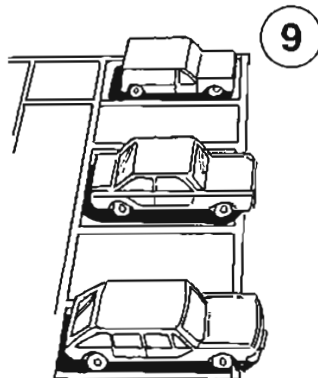
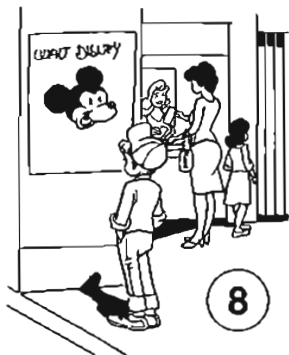
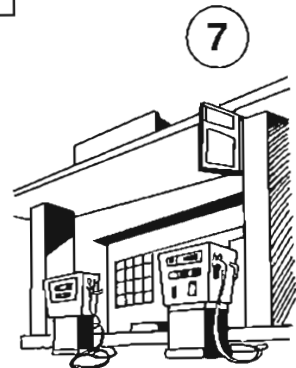
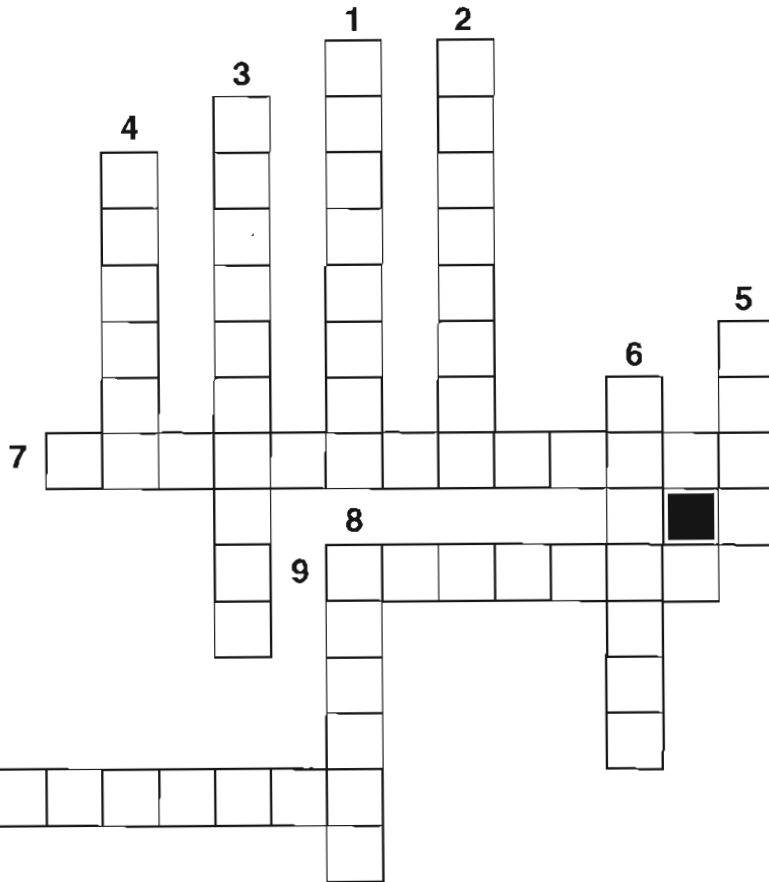
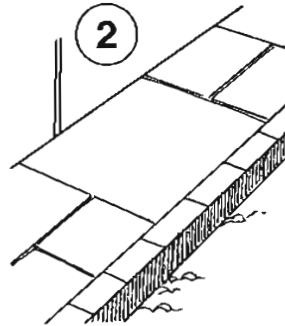
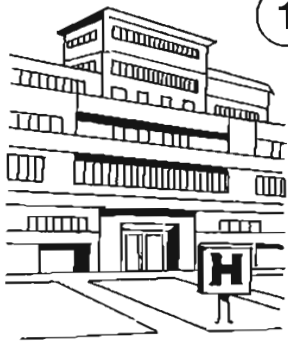

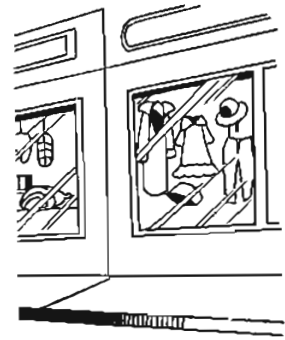

1



2



3



4

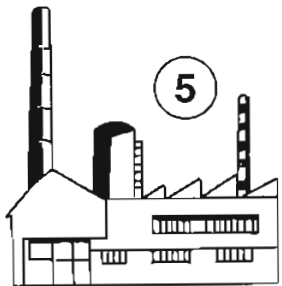
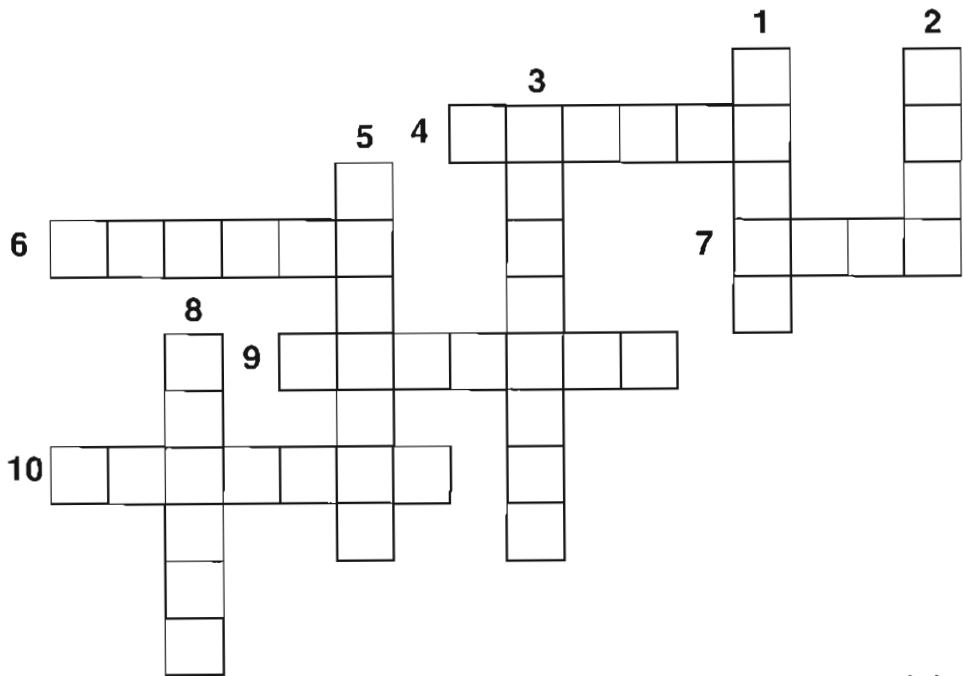

5

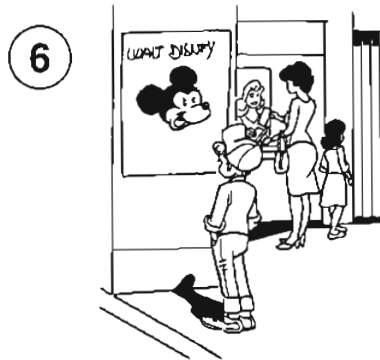

6

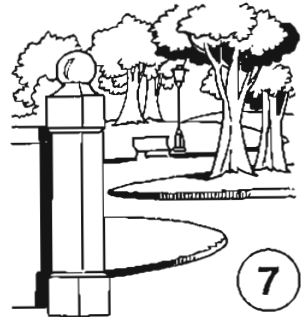

7



8

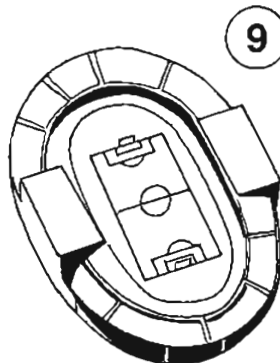

9

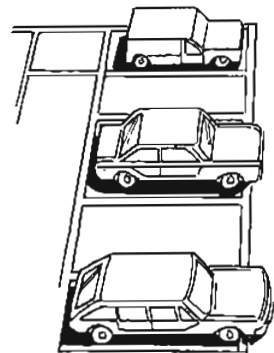

10

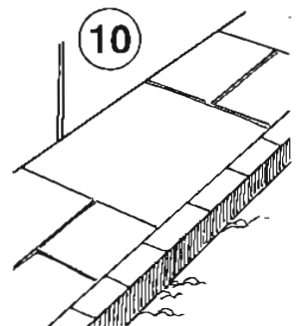
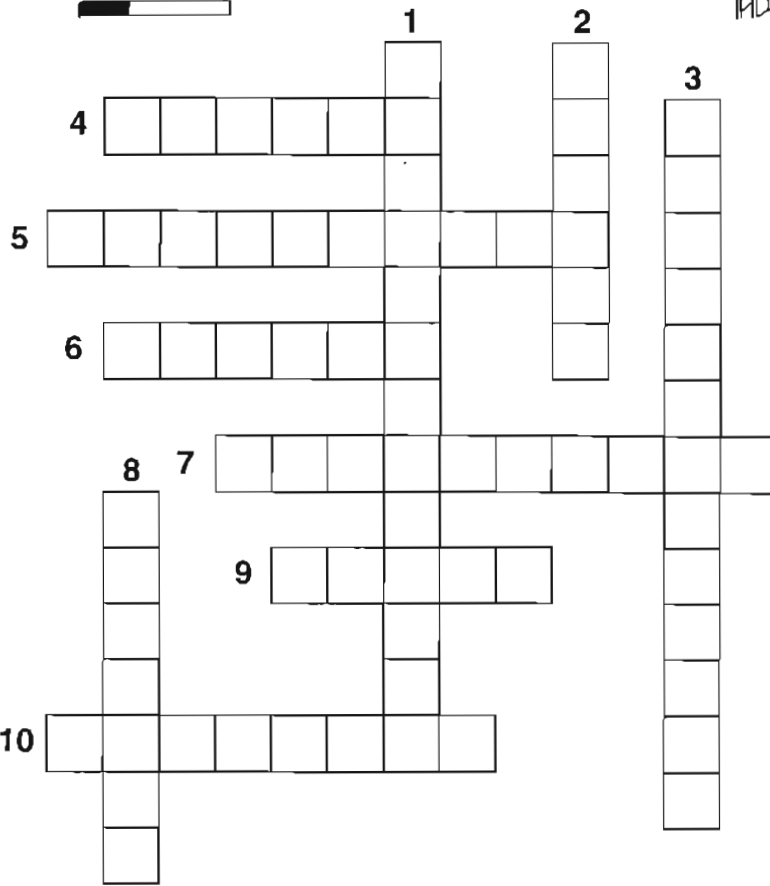
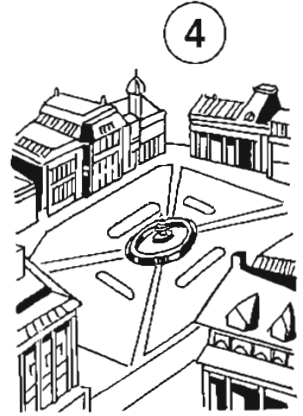
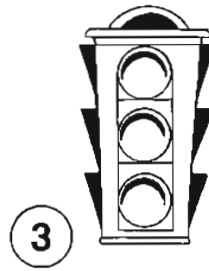
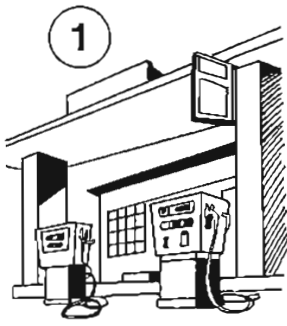
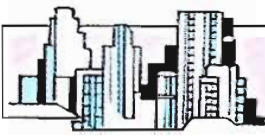

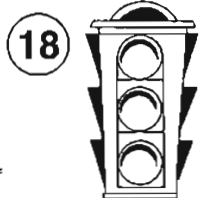
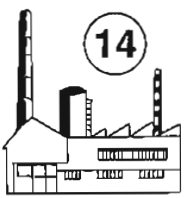
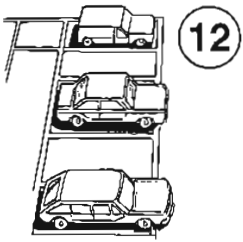
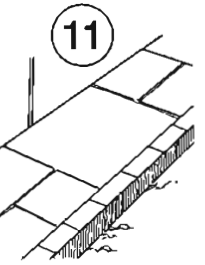
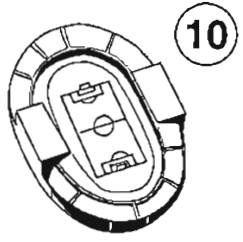
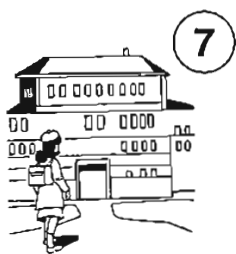
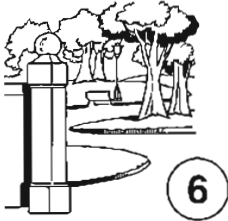
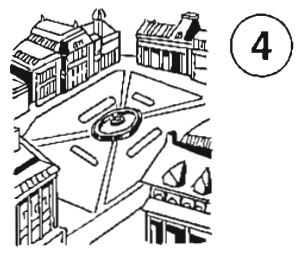
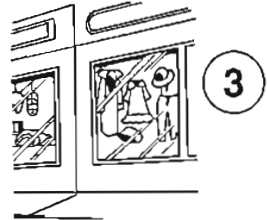
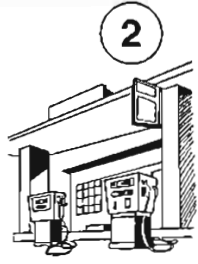

1

2

3

4

5

6

7

8

9

10

11

12

13

14

15

16

17

18

19

20



CLOTHES



dress



skirt



shirt



sweater



trousers



jacket



coat

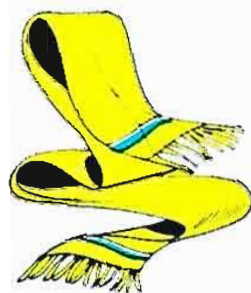

scarf



shorts



socks



underwear



T-shirt



shoes



slippers



sandals



tie



pyjamas



gloves



wellingtons

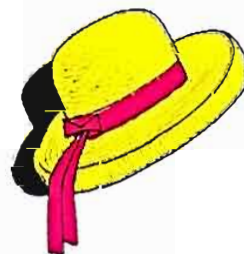

hat

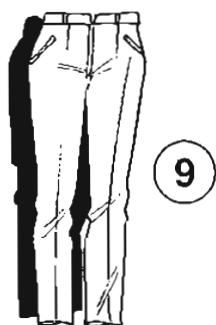
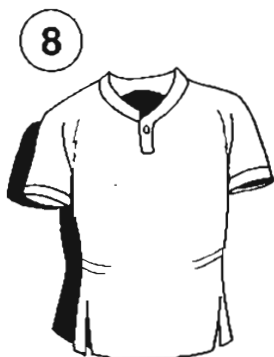
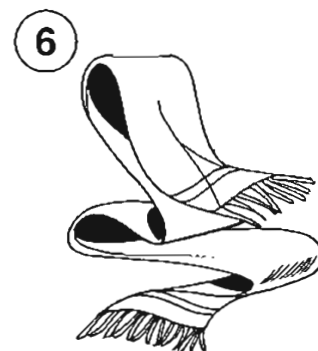
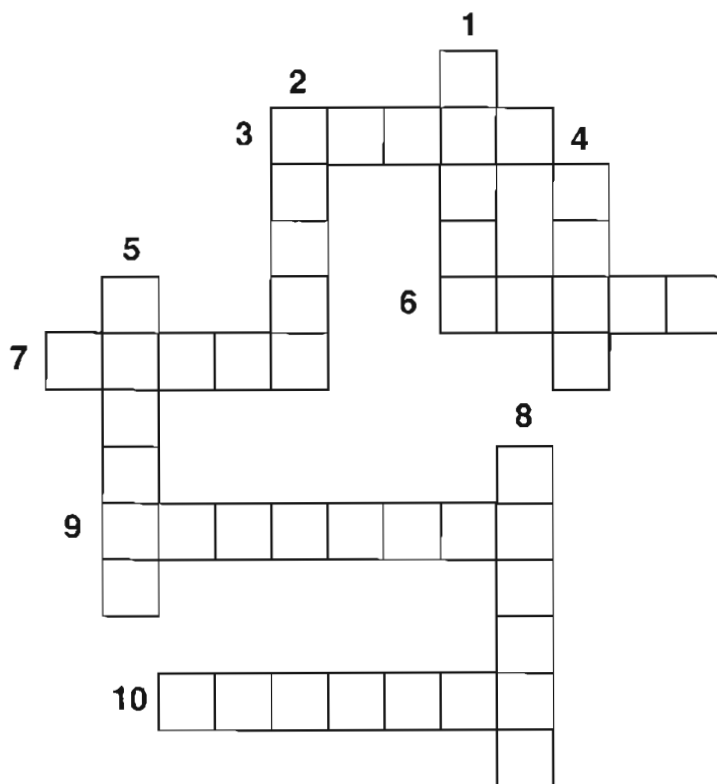
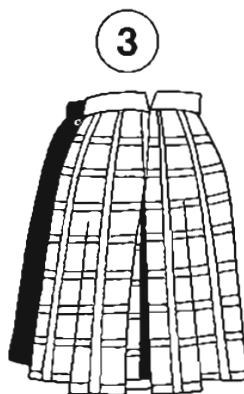
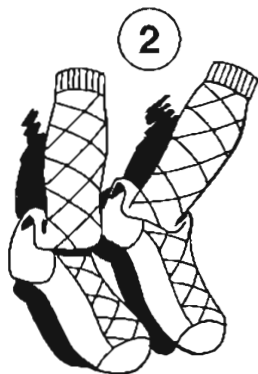
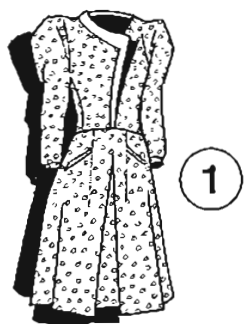

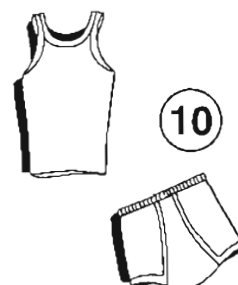
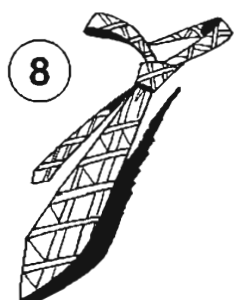
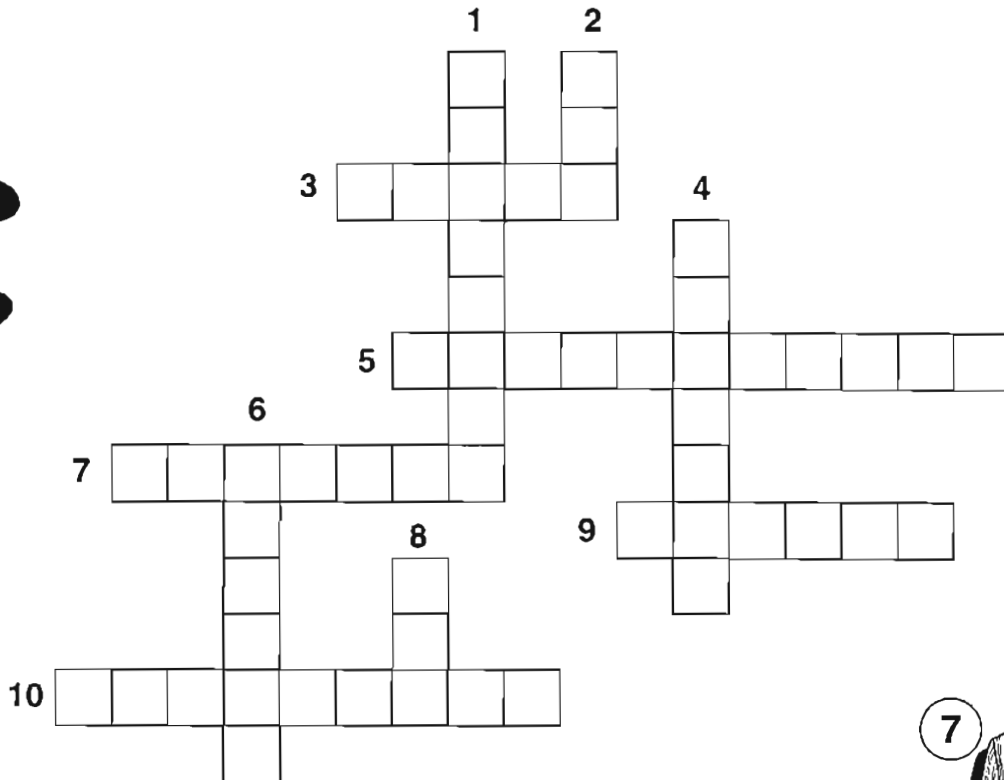
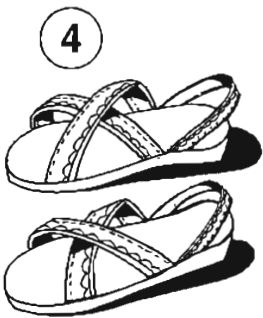
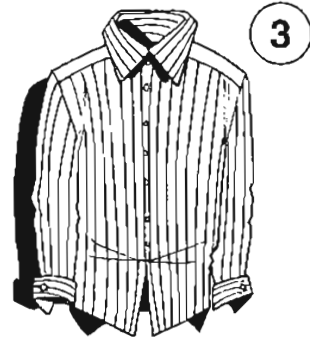
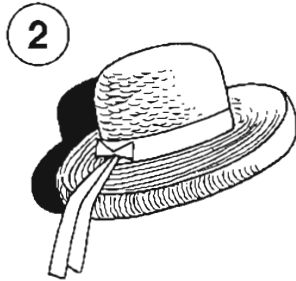

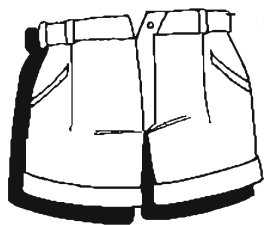

1

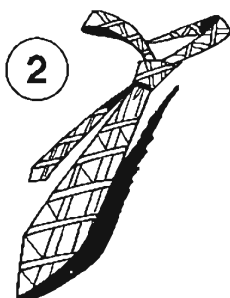

2

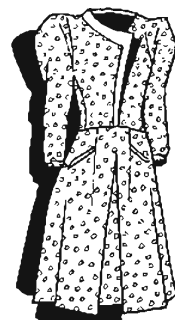

3



4

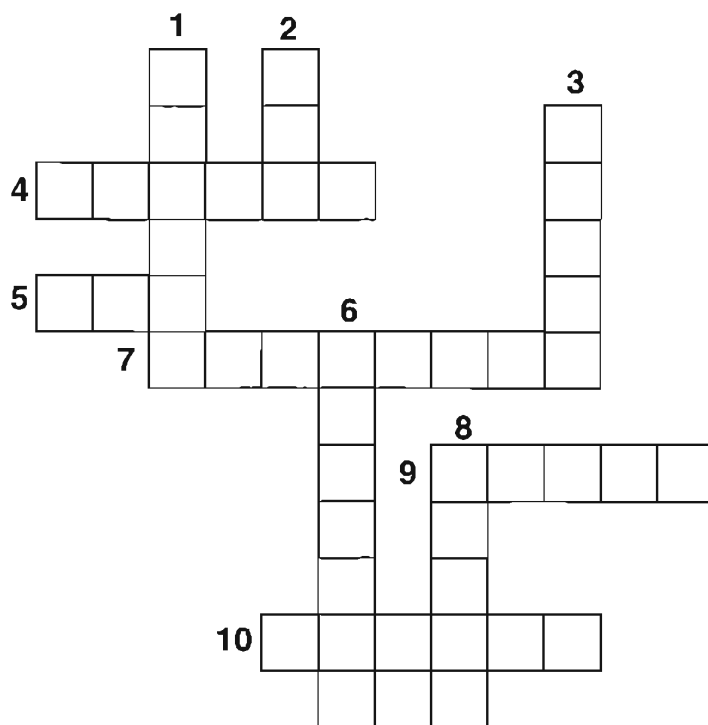

5

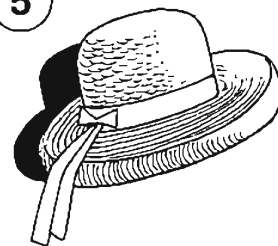

6



7

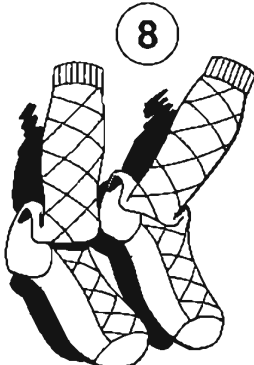

8

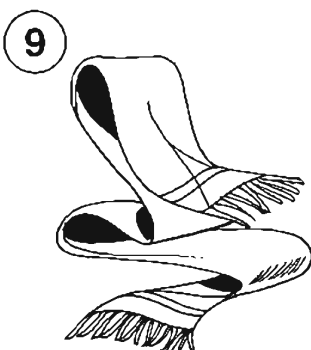

9



10

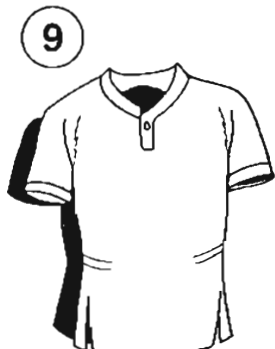
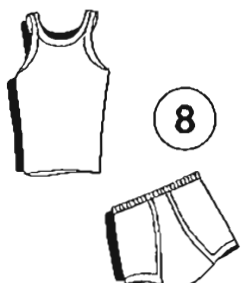
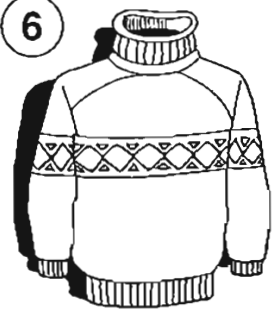
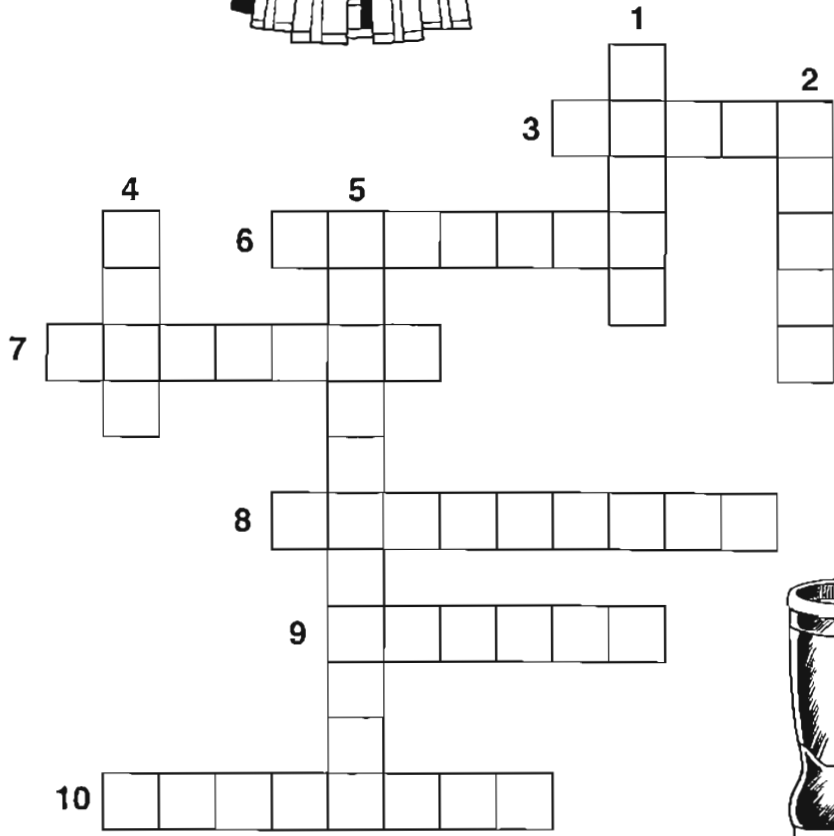
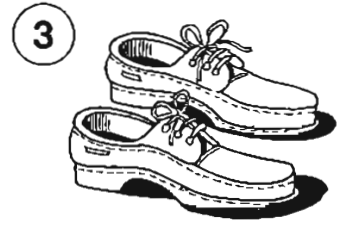

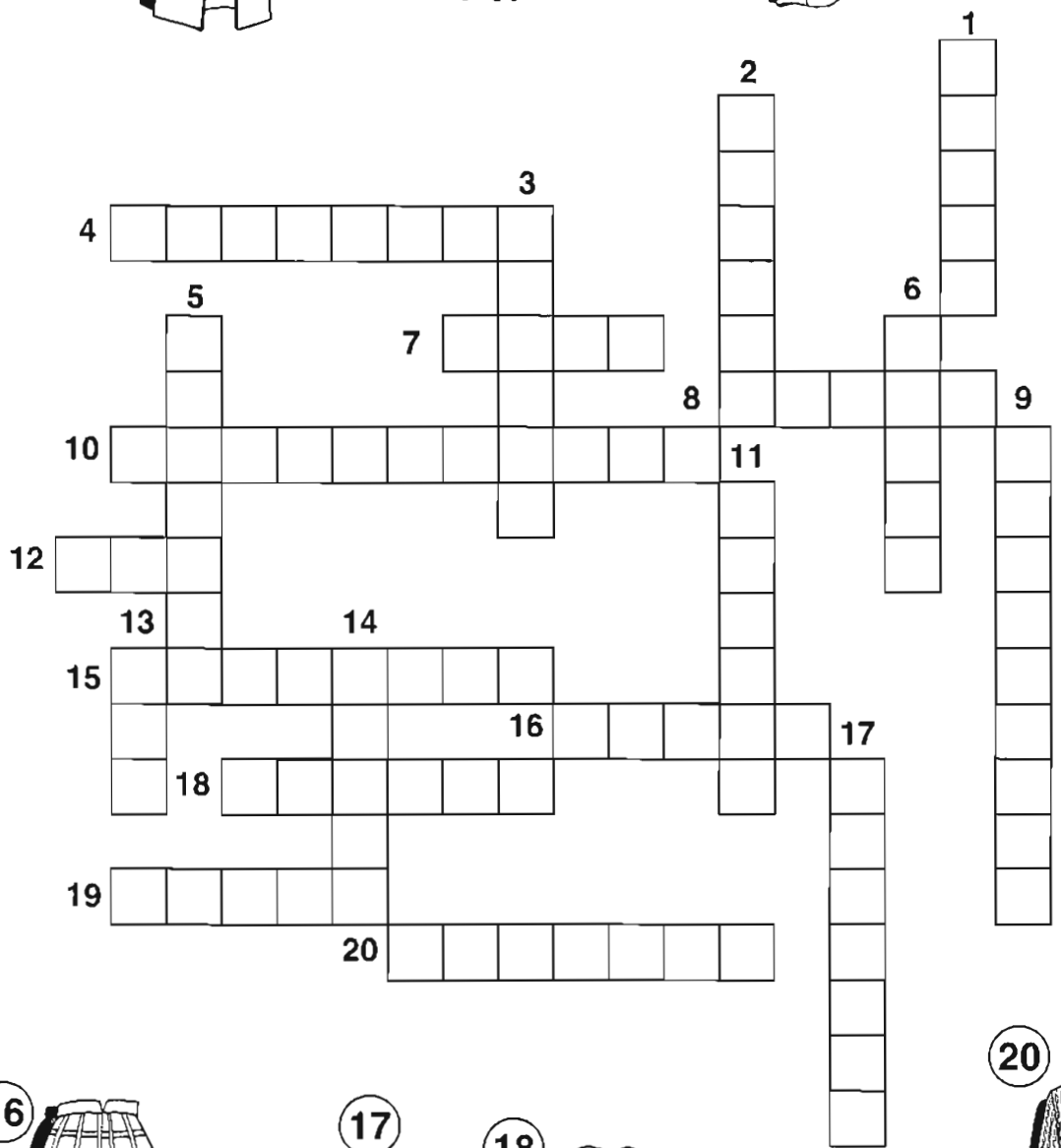
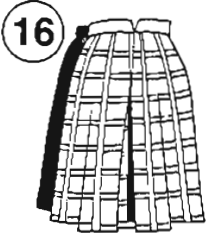
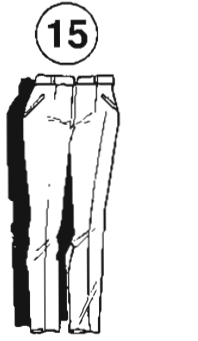



ON SAFARI



penguin



camel

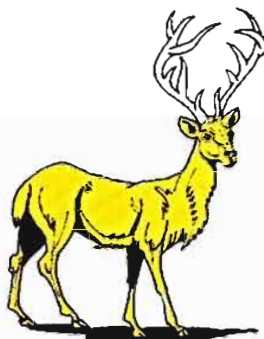

deer

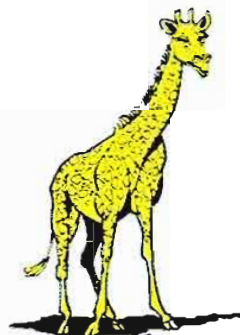

giraffe



panda



hippopotamus



tortoise



zebra



snake



rhinoceros



lion



tiger



kangaroo

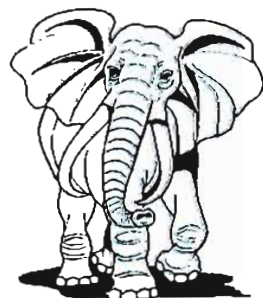

elephant

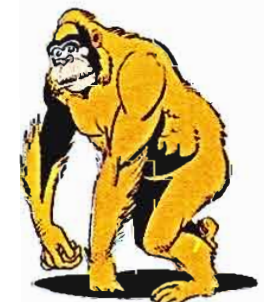

gorilla



monkey

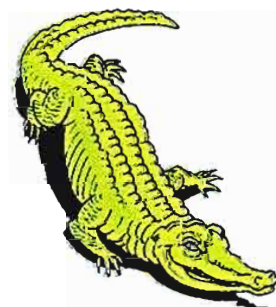

crocodile



wolf



seal



bear

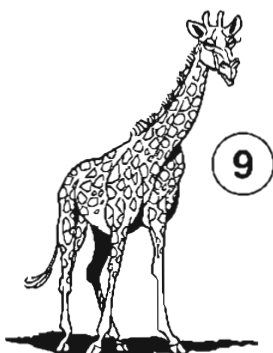
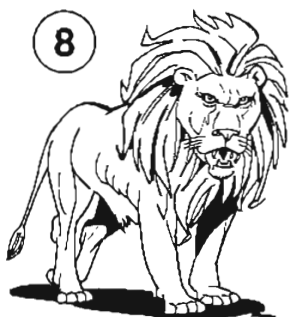
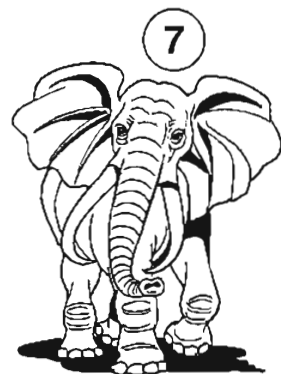
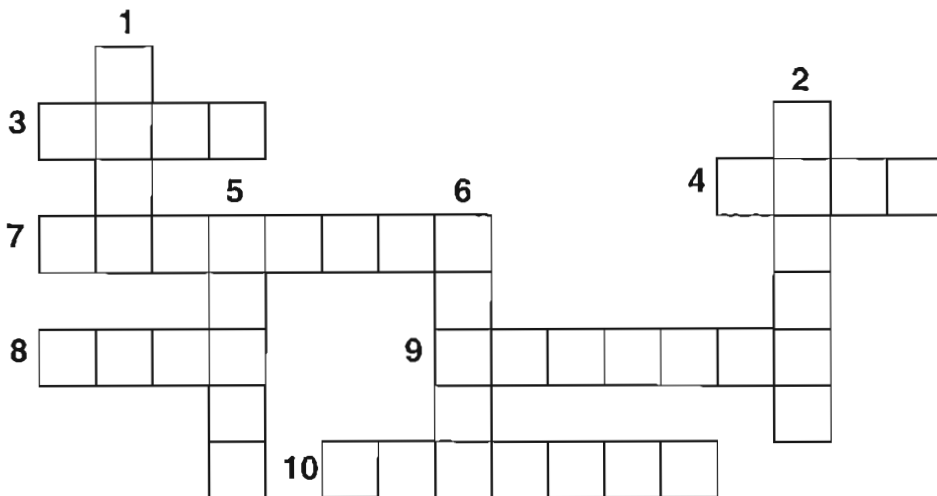

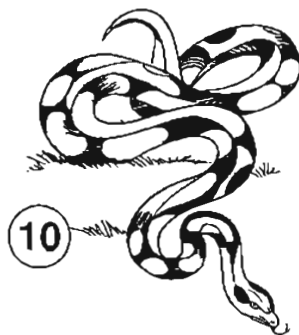
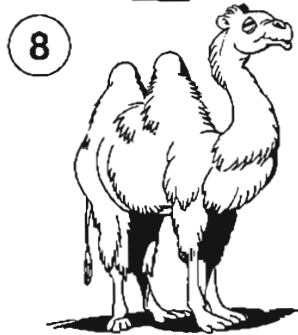
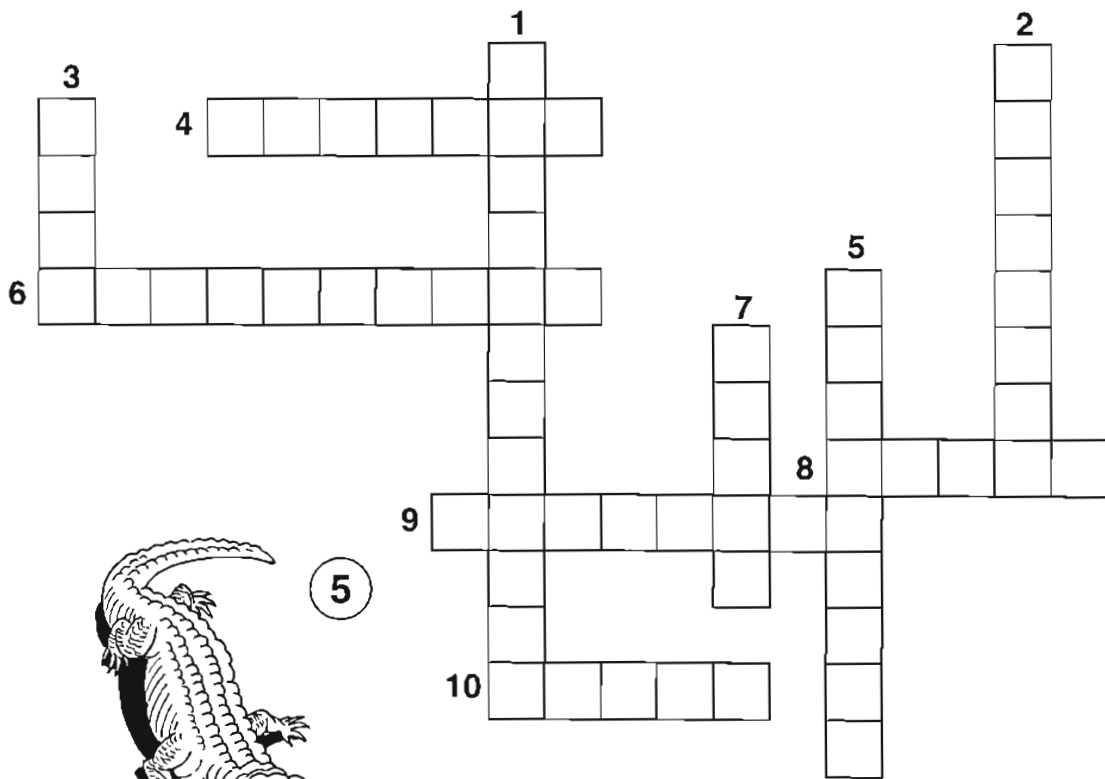
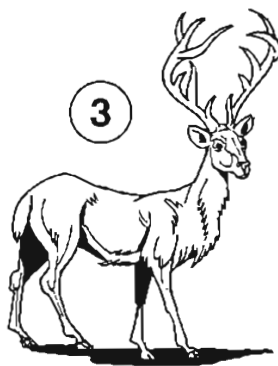
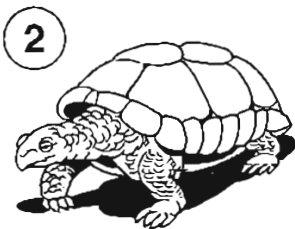
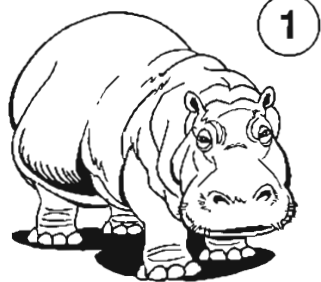

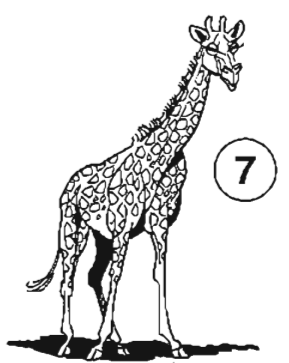
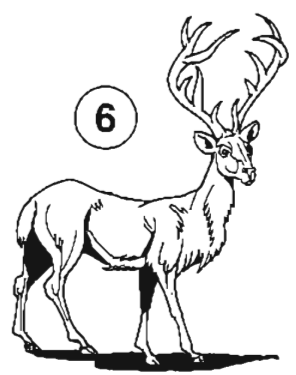
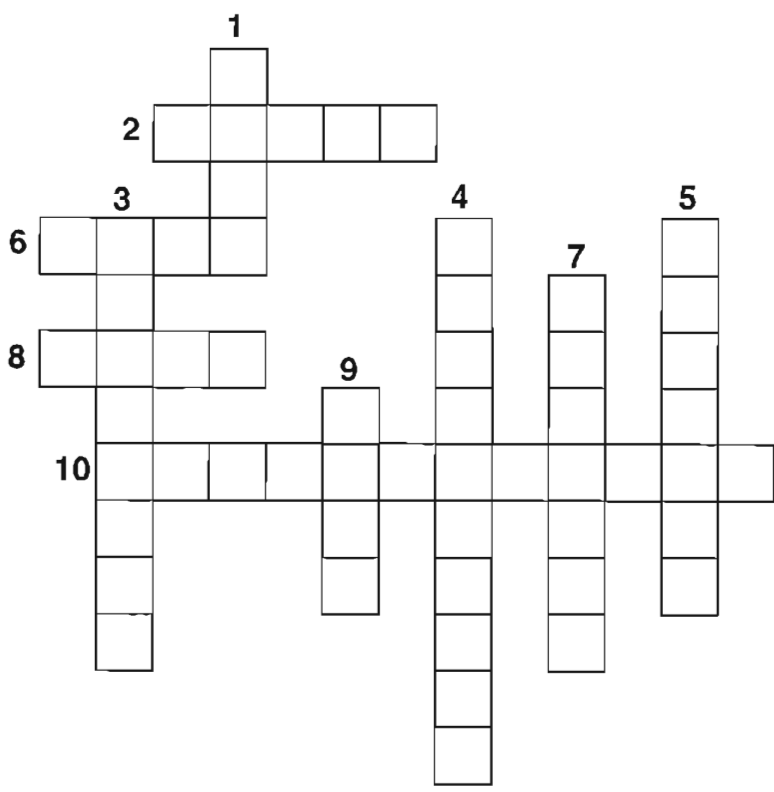
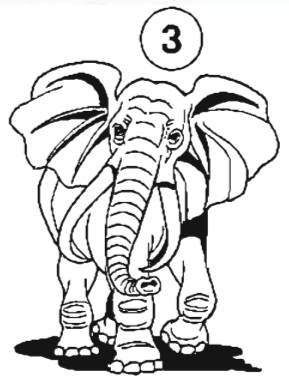

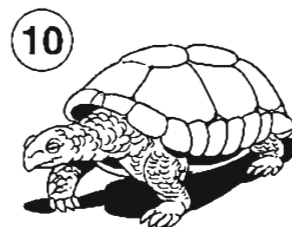
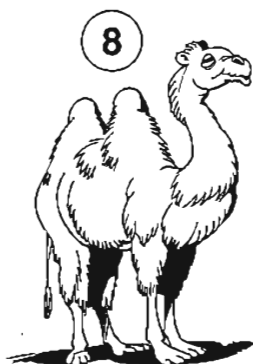
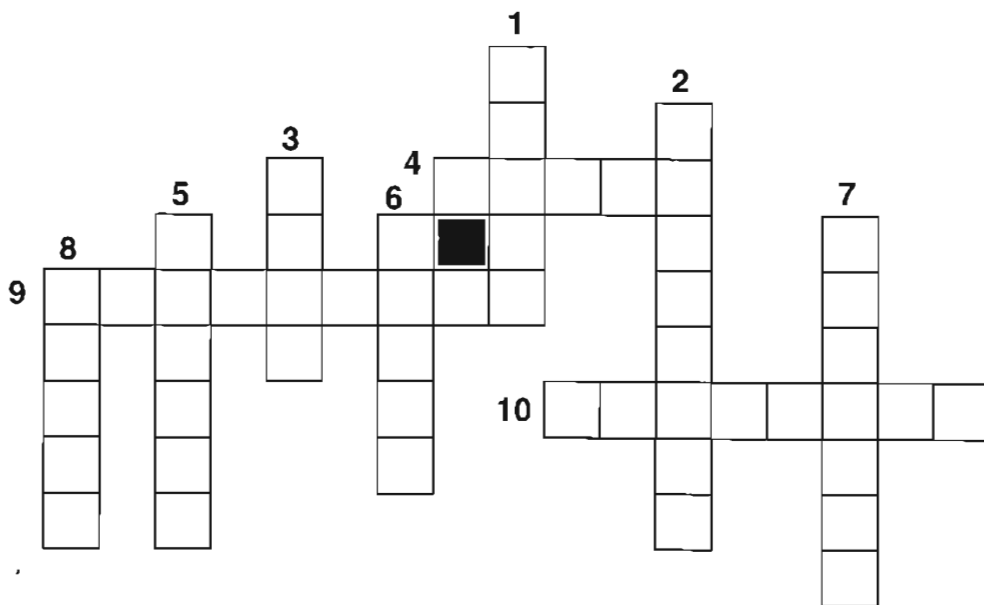
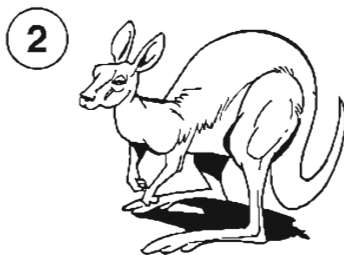
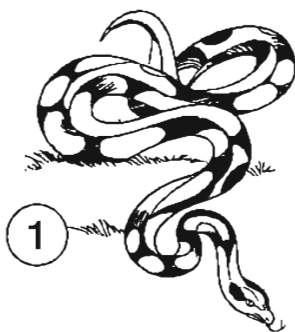

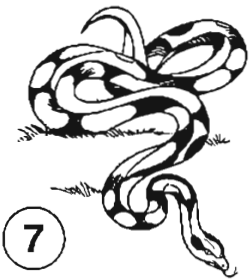
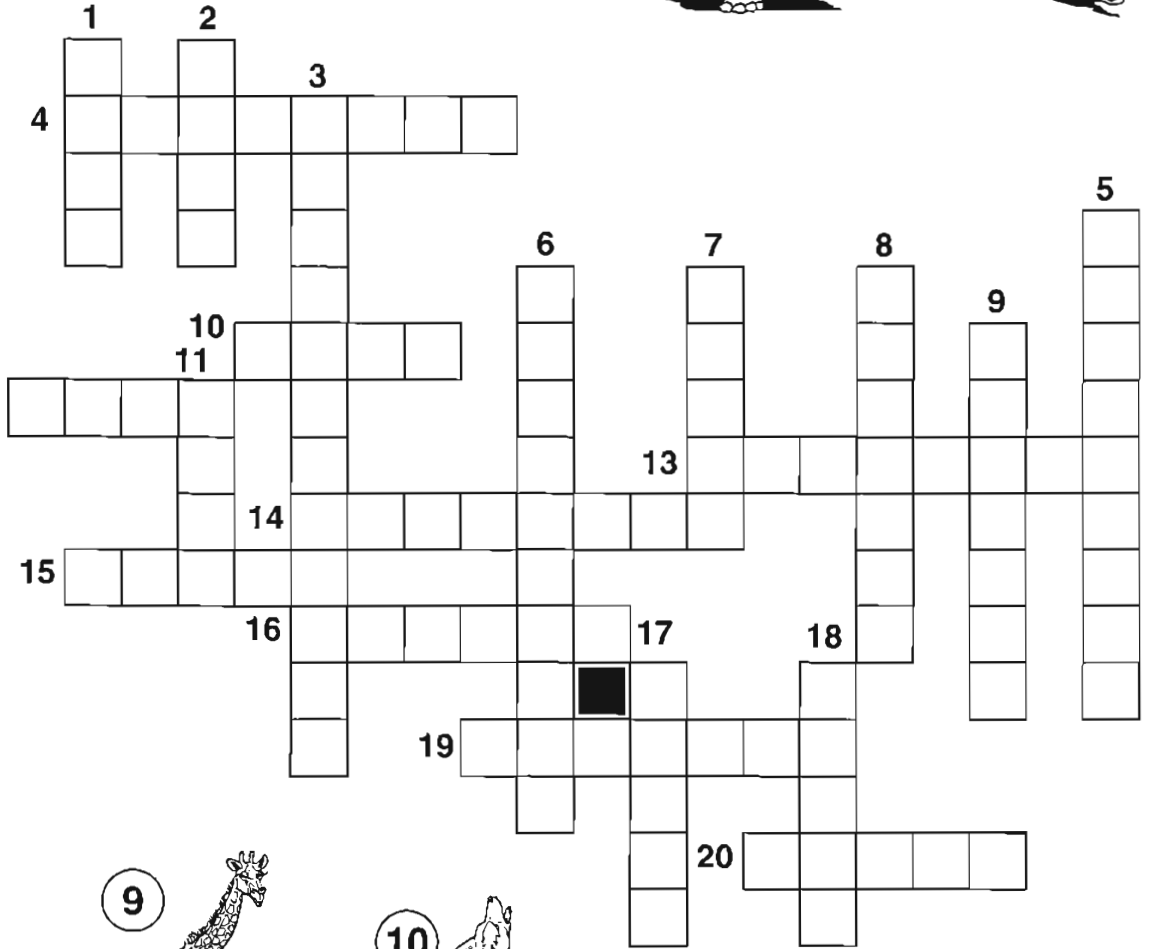
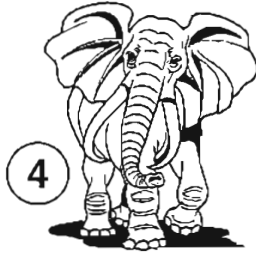
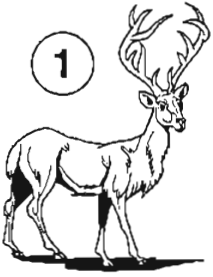



OPPOSITES



fast



slow



hot



cold



big



small



tall



short

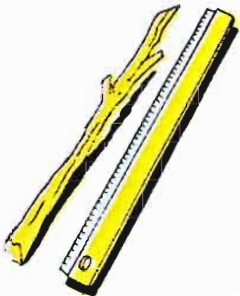

long

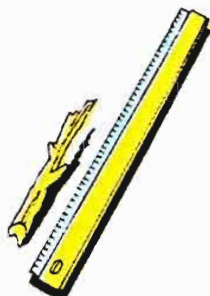

short

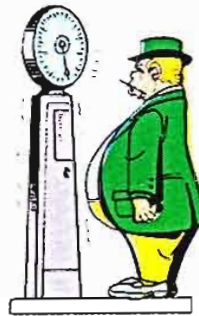

fat



thin



sweet



bitter



pretty



ugly



new



old



full



empty

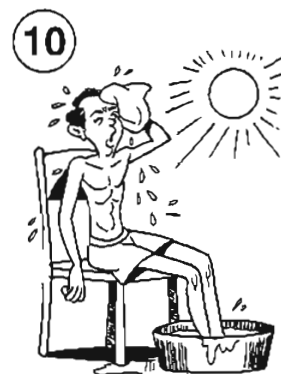
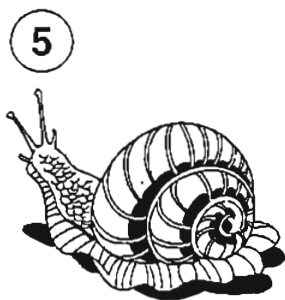
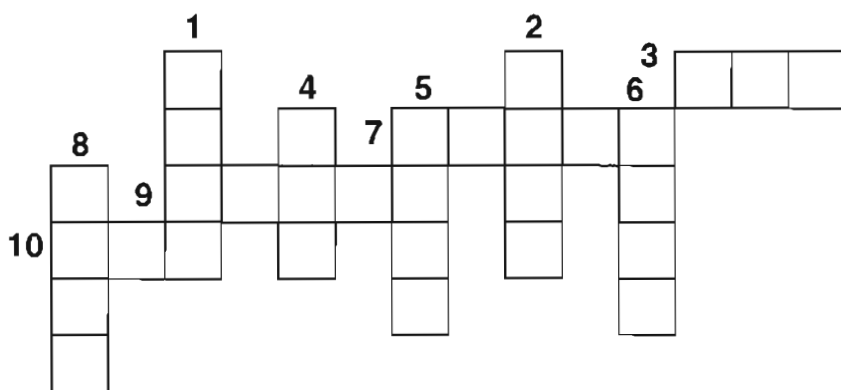
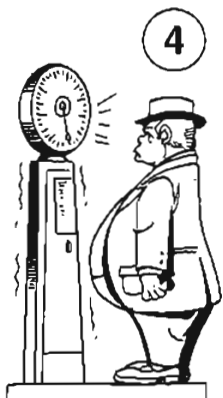
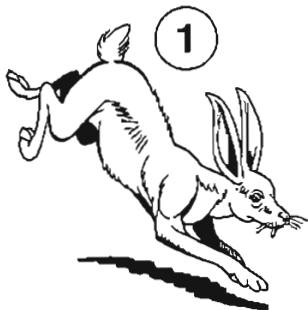

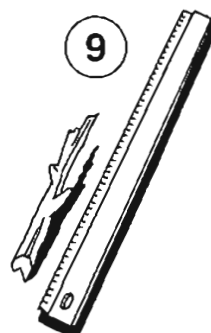
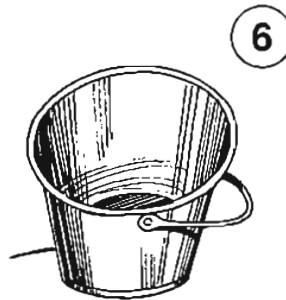
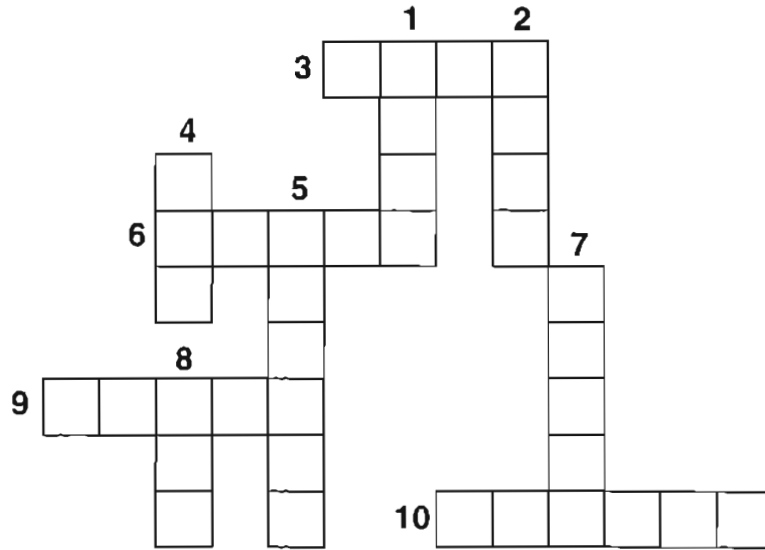
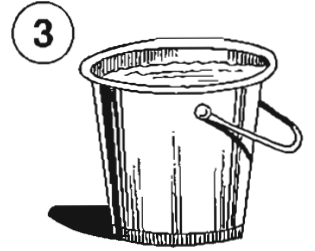
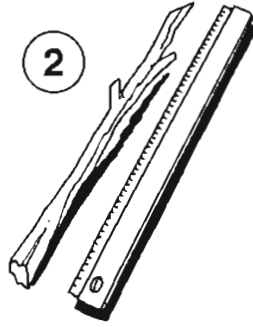

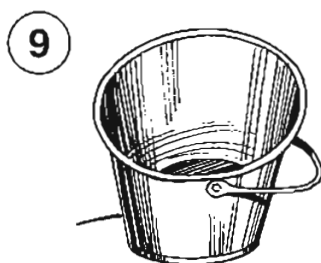
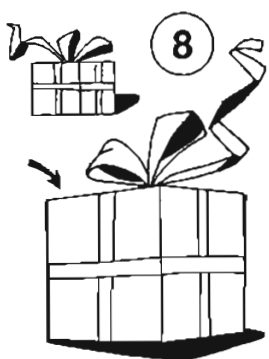
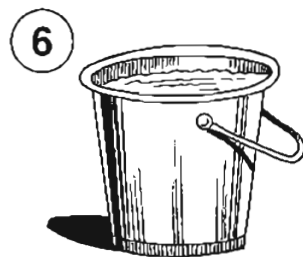
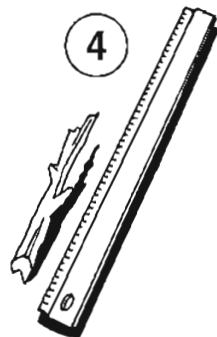
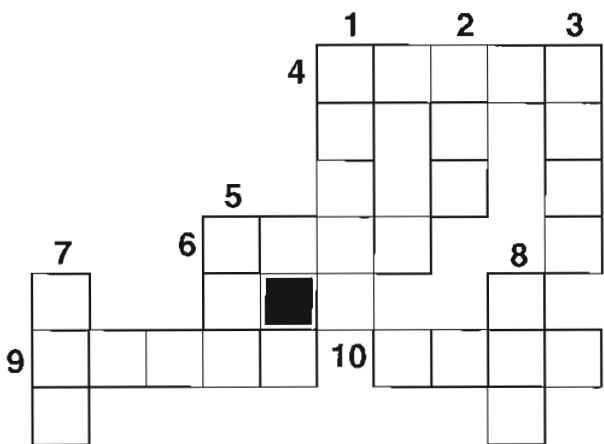
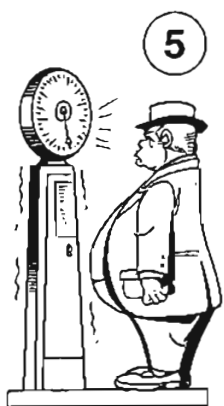
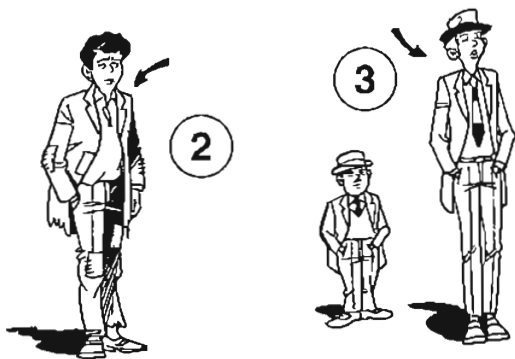

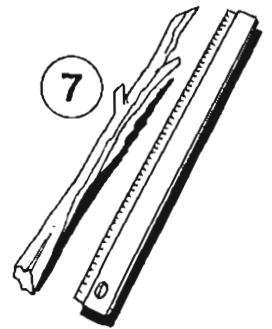
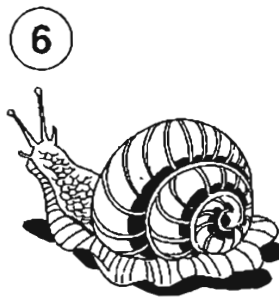
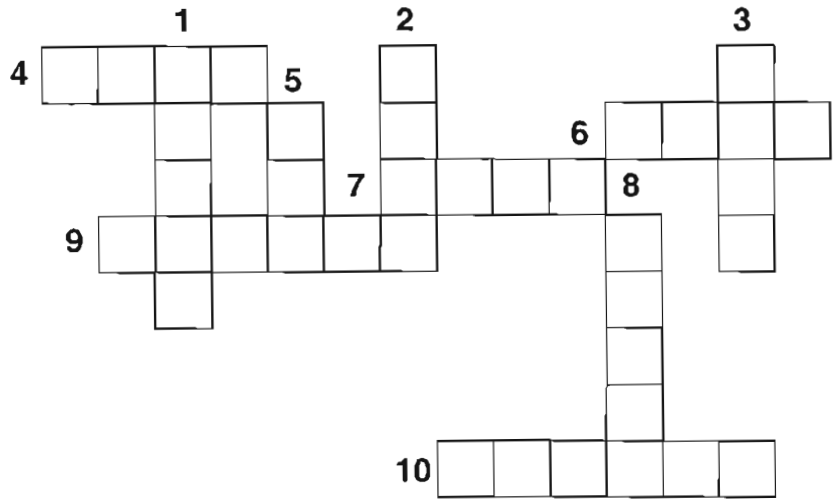
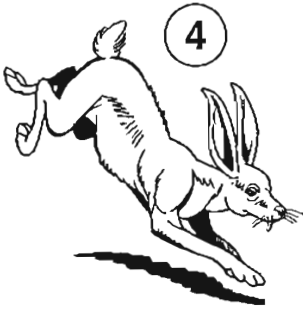



6



7



8



9



10



11



12



13

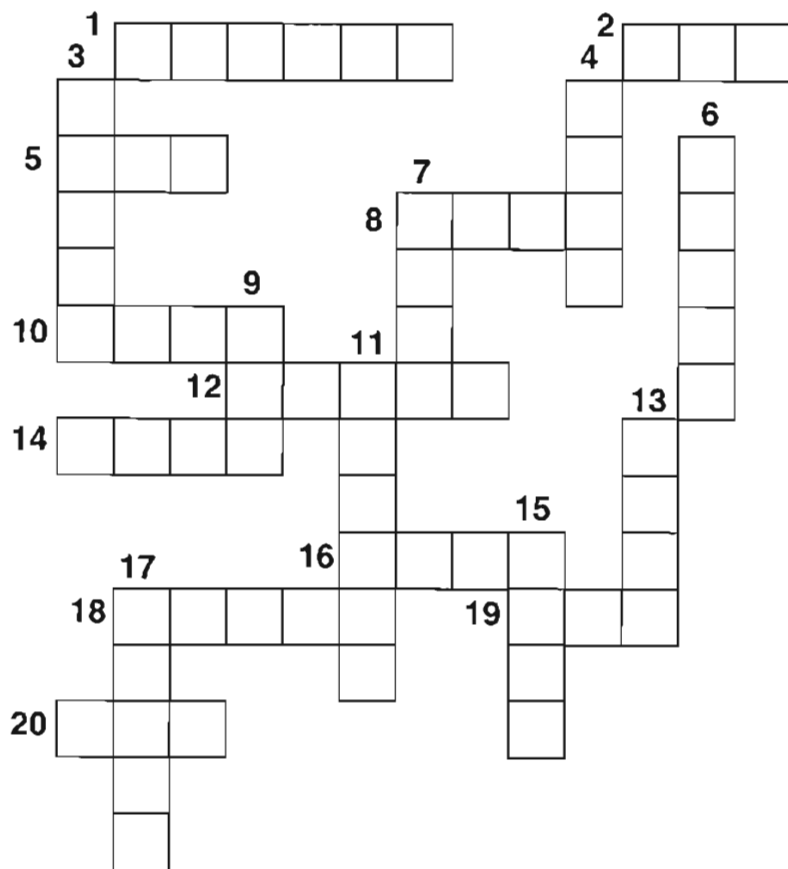

14



15

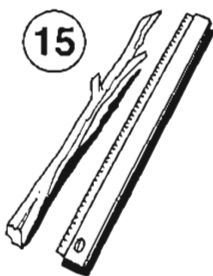

16



17

18

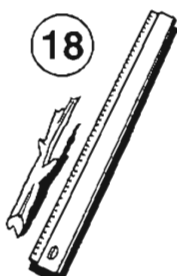

19



20



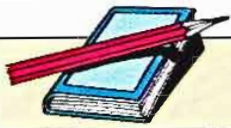

AT SCHOOL



rubber

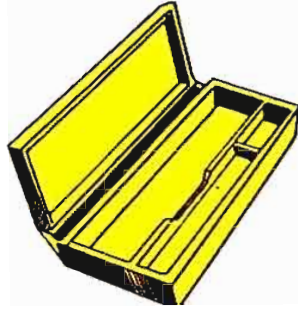

pencil case

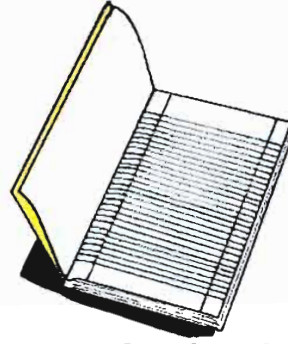

exercise book



pen

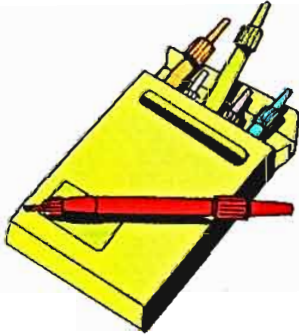

felt-tip pens

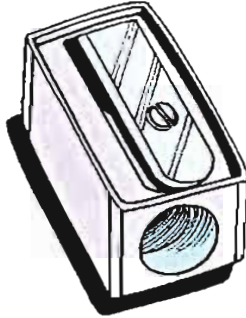

pencil sharpener

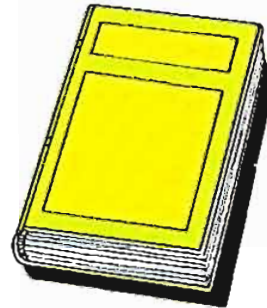

book



glue



coloured pencils



scissors

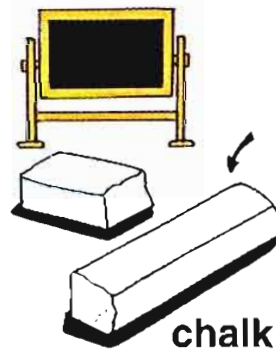

chalk

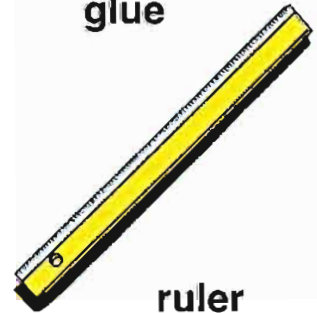

ruler

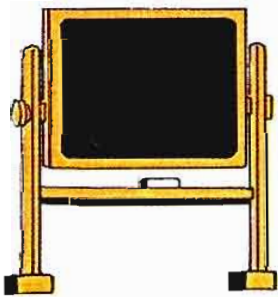

blackboard

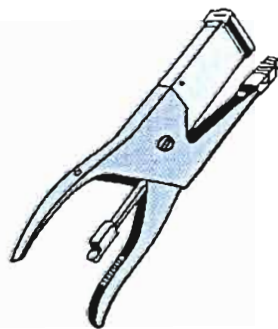

stapler



paintbrush

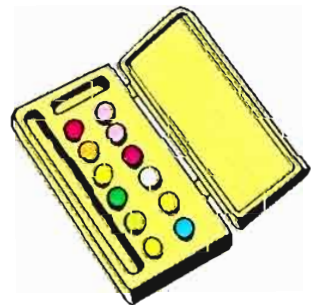

paints

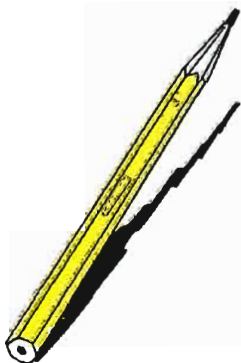

pencil



teacher



waste-paper basket

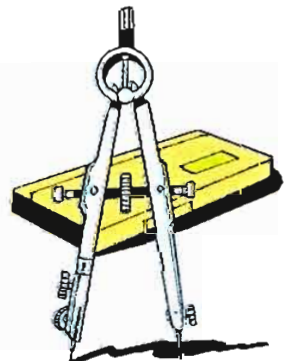

compass

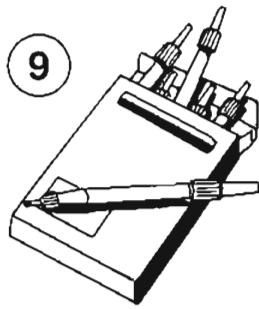
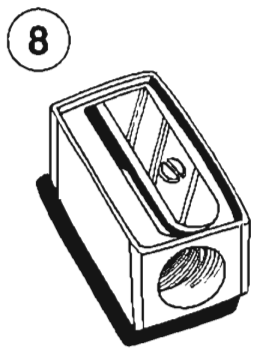
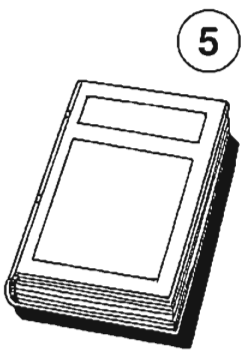
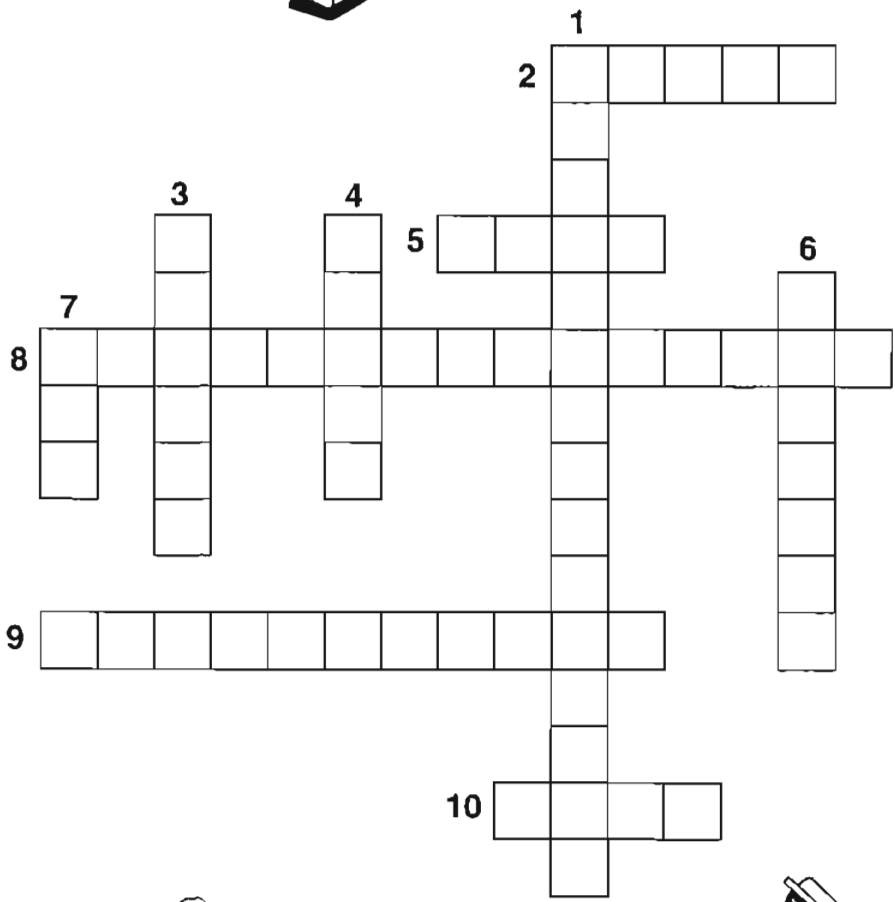
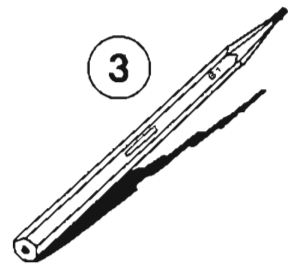
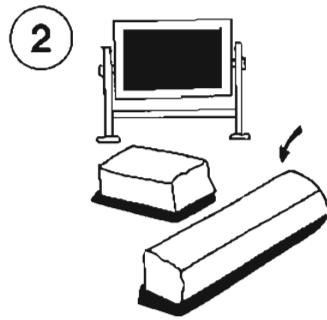
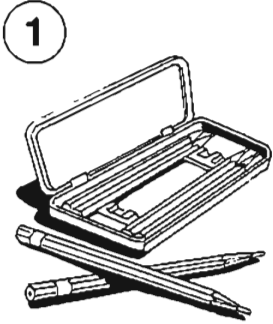
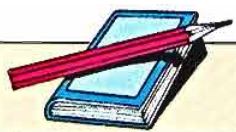

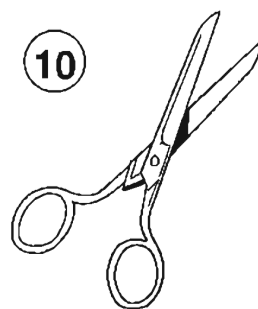
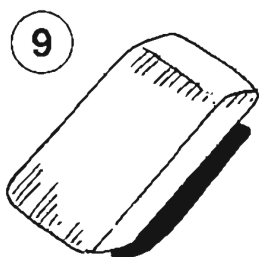
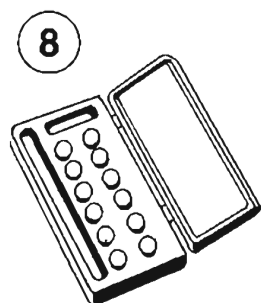
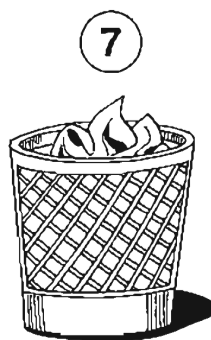
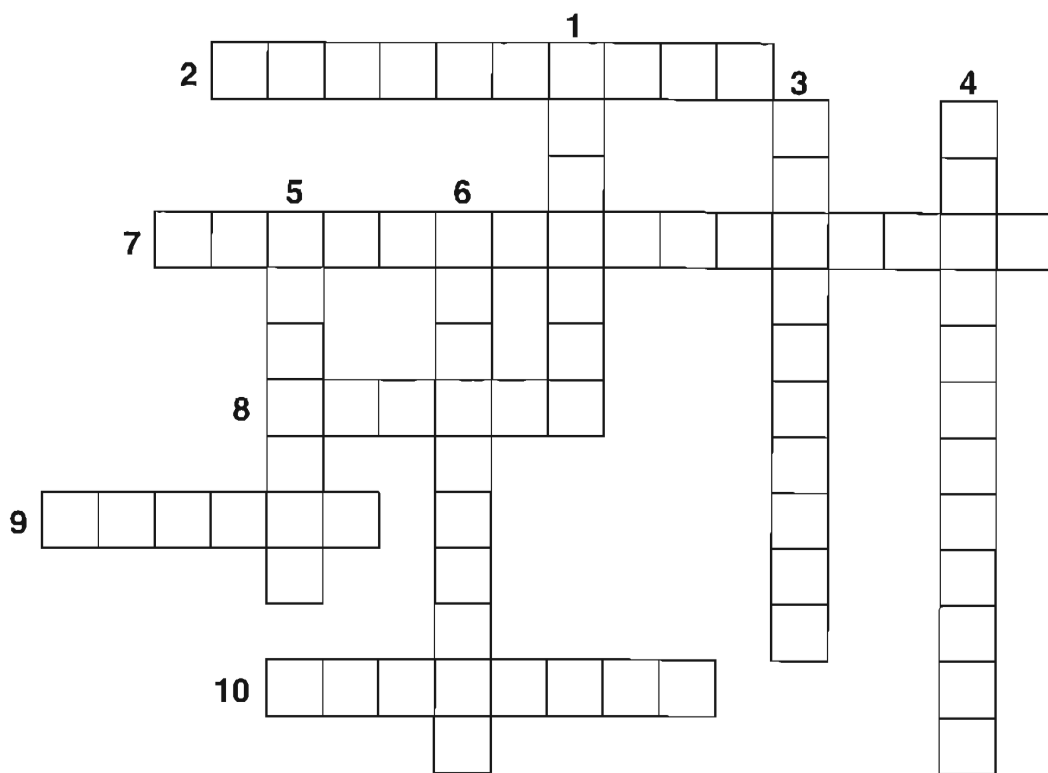
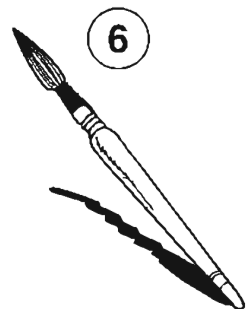
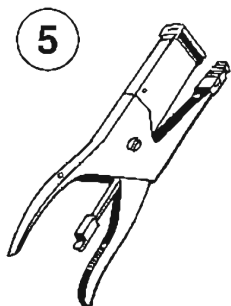
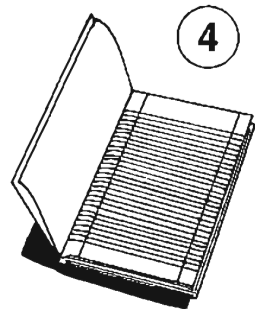
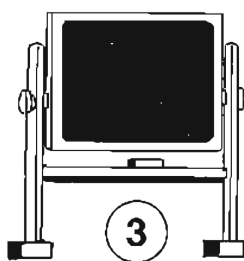
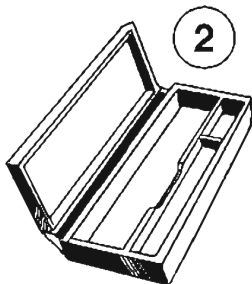
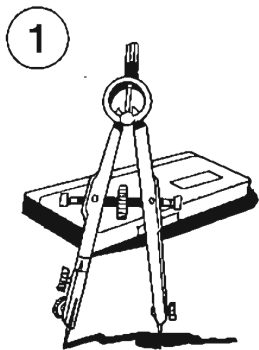
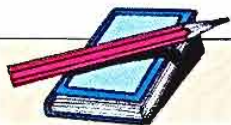

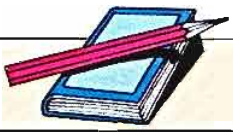

1

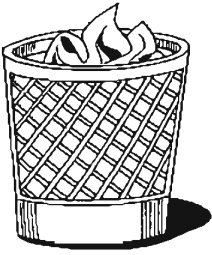

2

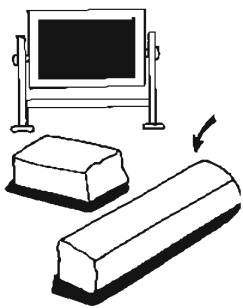

3

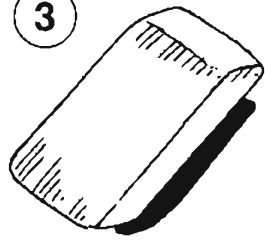

4

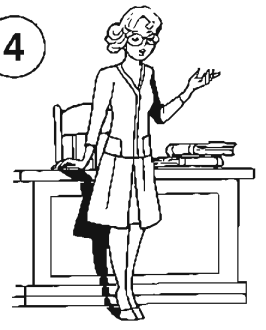

5

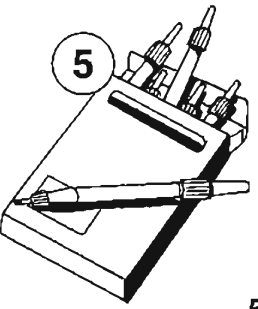

1

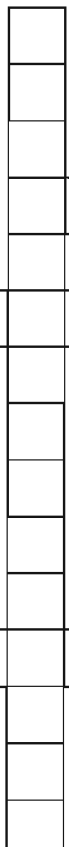

2



3

4

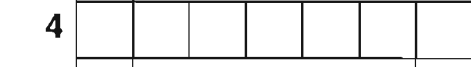

6

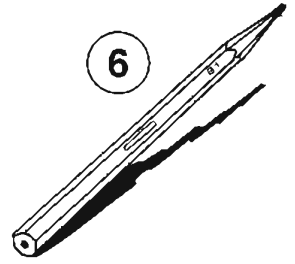

5

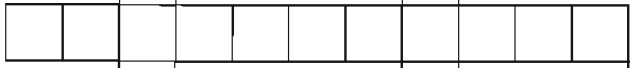

6

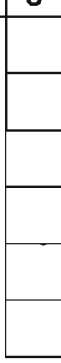

7



8



9

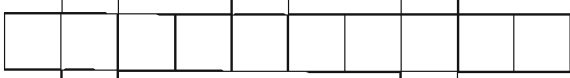

7

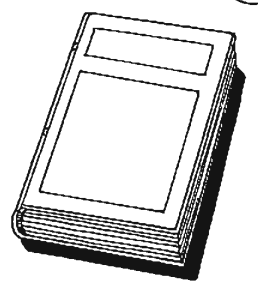

10

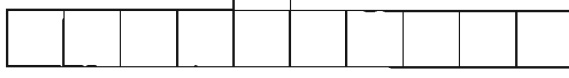

8



9

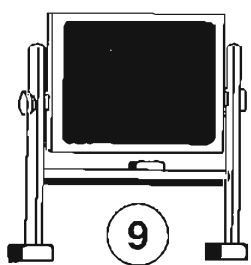

10

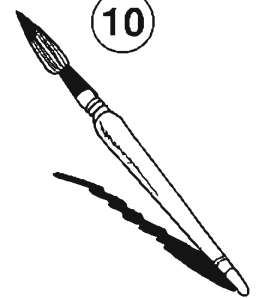

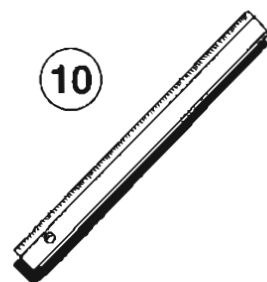
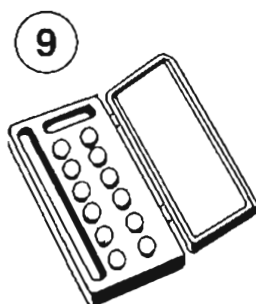
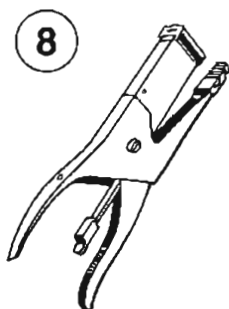
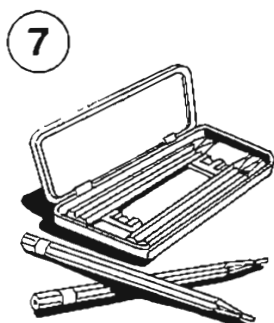
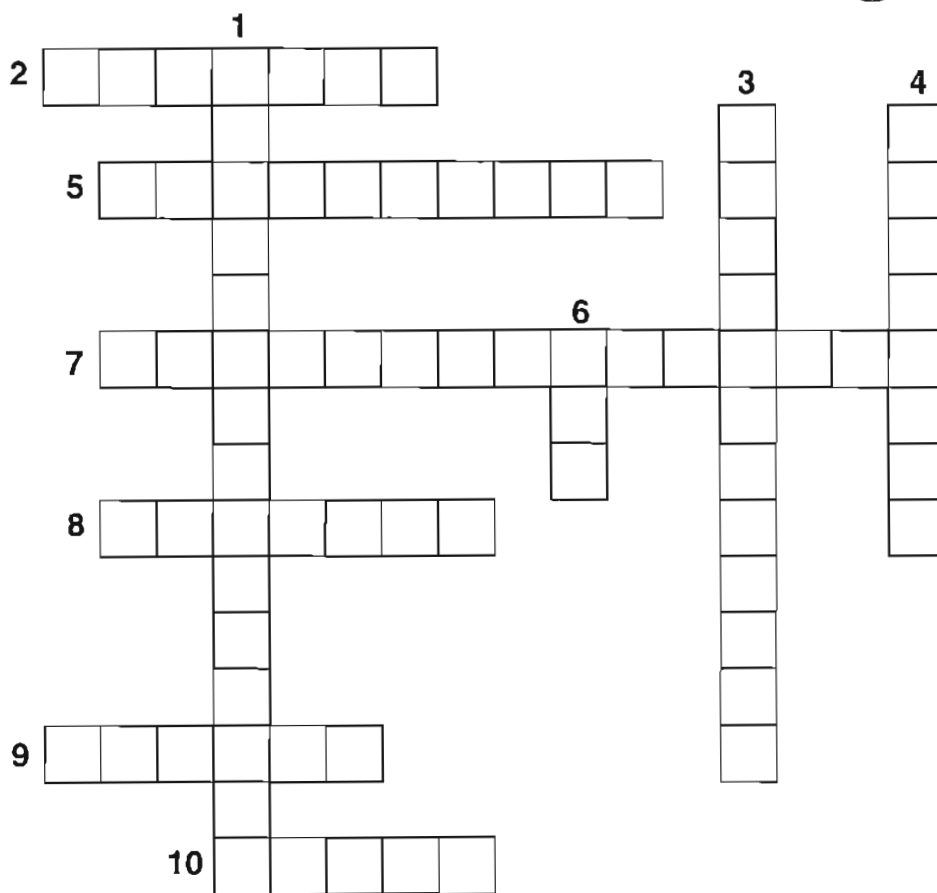
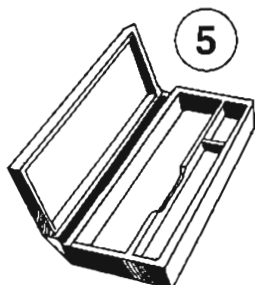
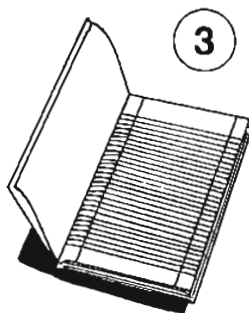
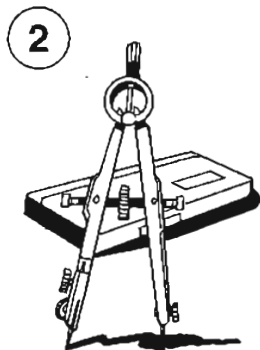
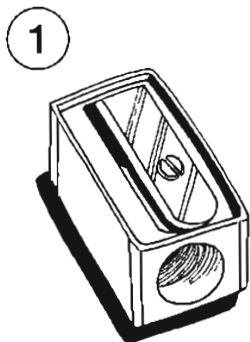

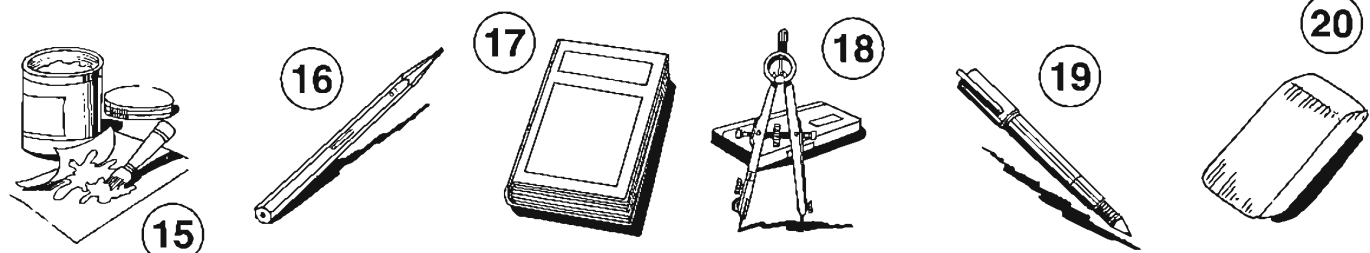
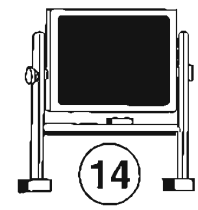
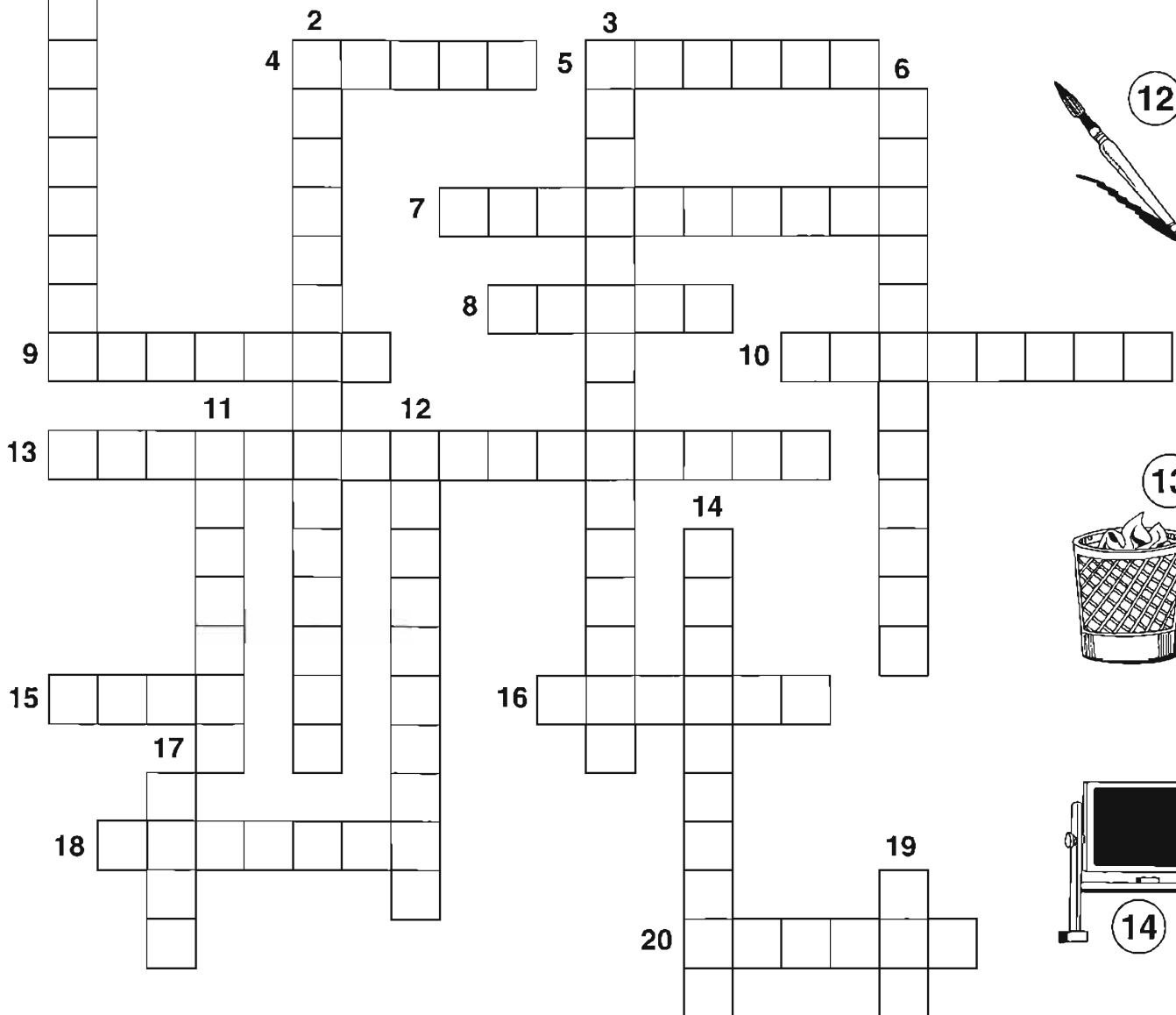
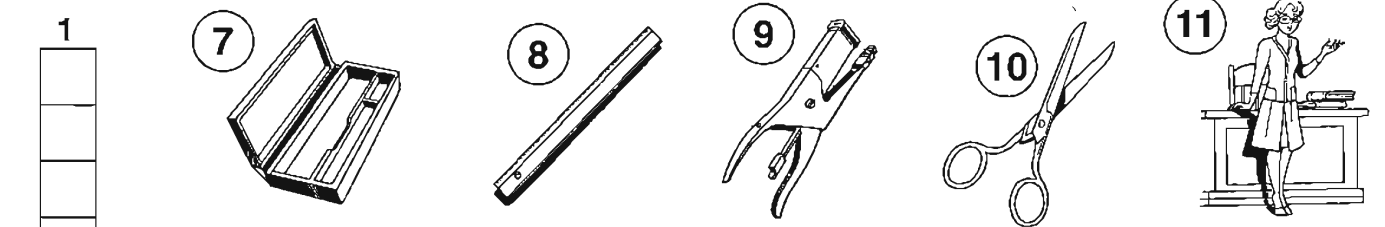
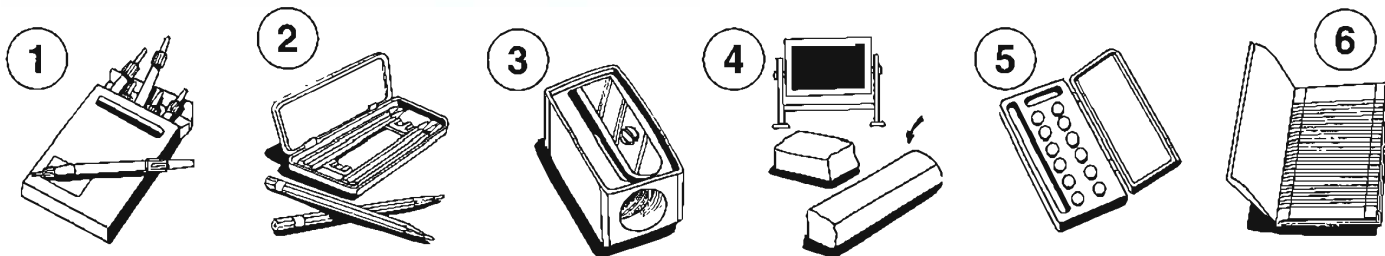



ACTIONS



go down



go up

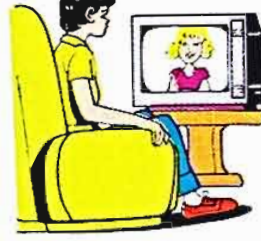

watch



eat



sleep



go in



go out



drink



write



read



fall



pull



push



draw



speak



listen



telephone



walk



cry



laugh

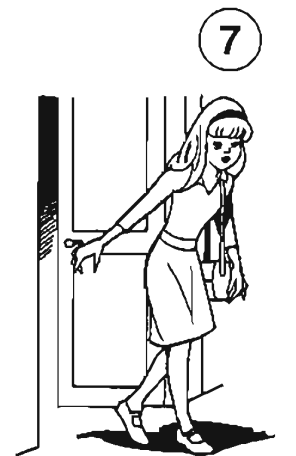
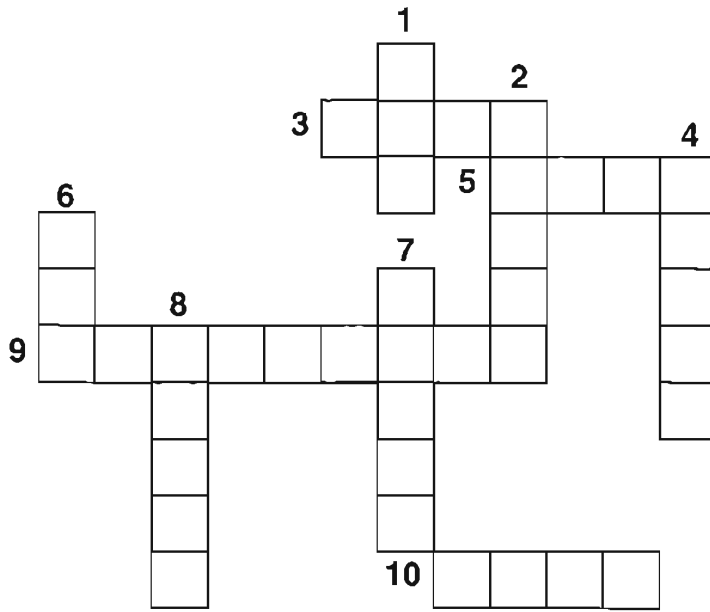

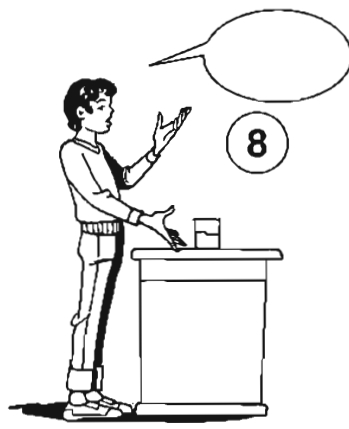
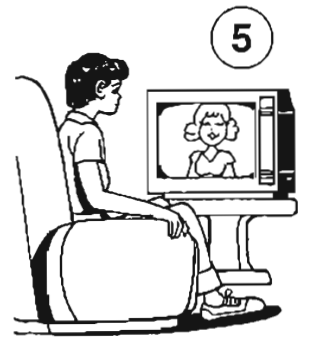
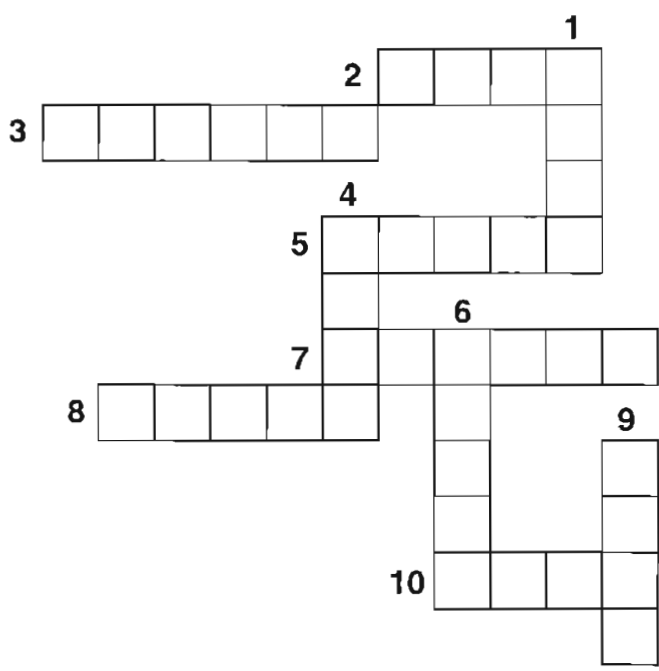
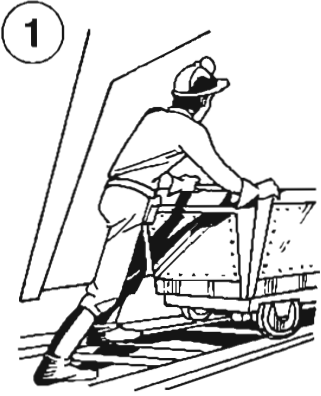

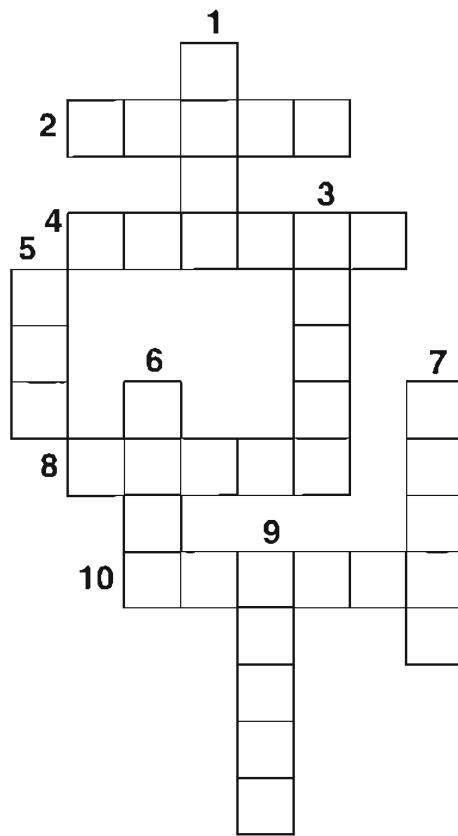
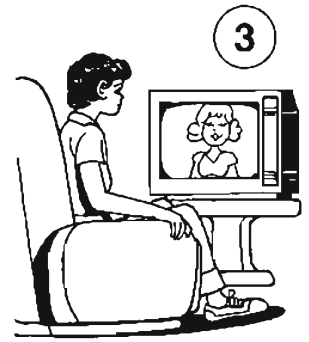
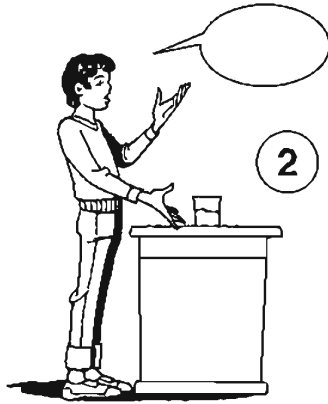

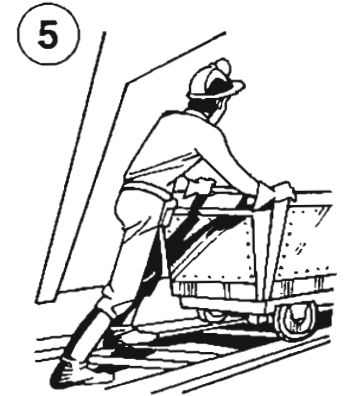
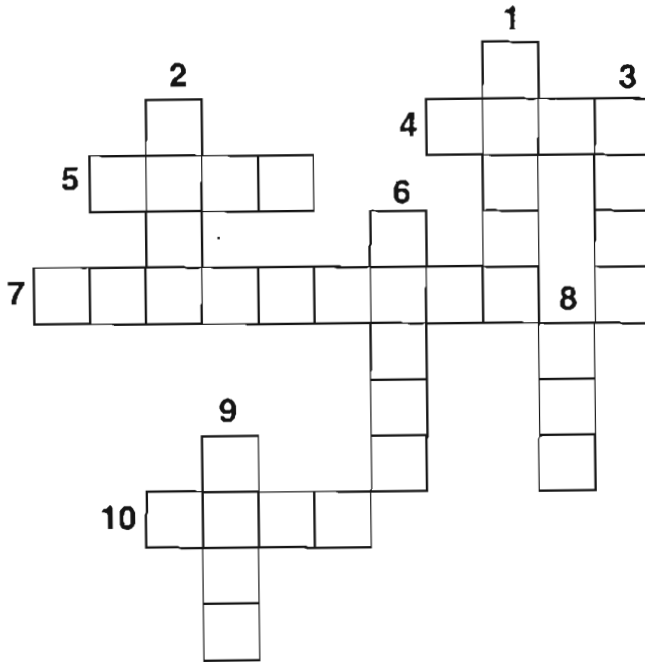

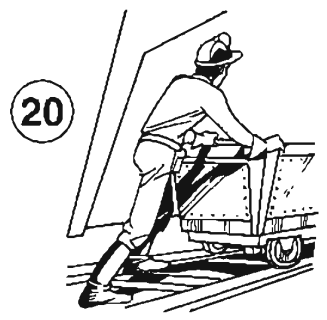
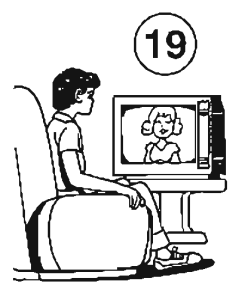
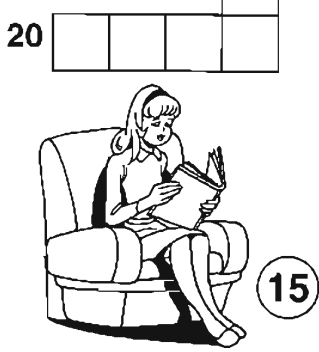
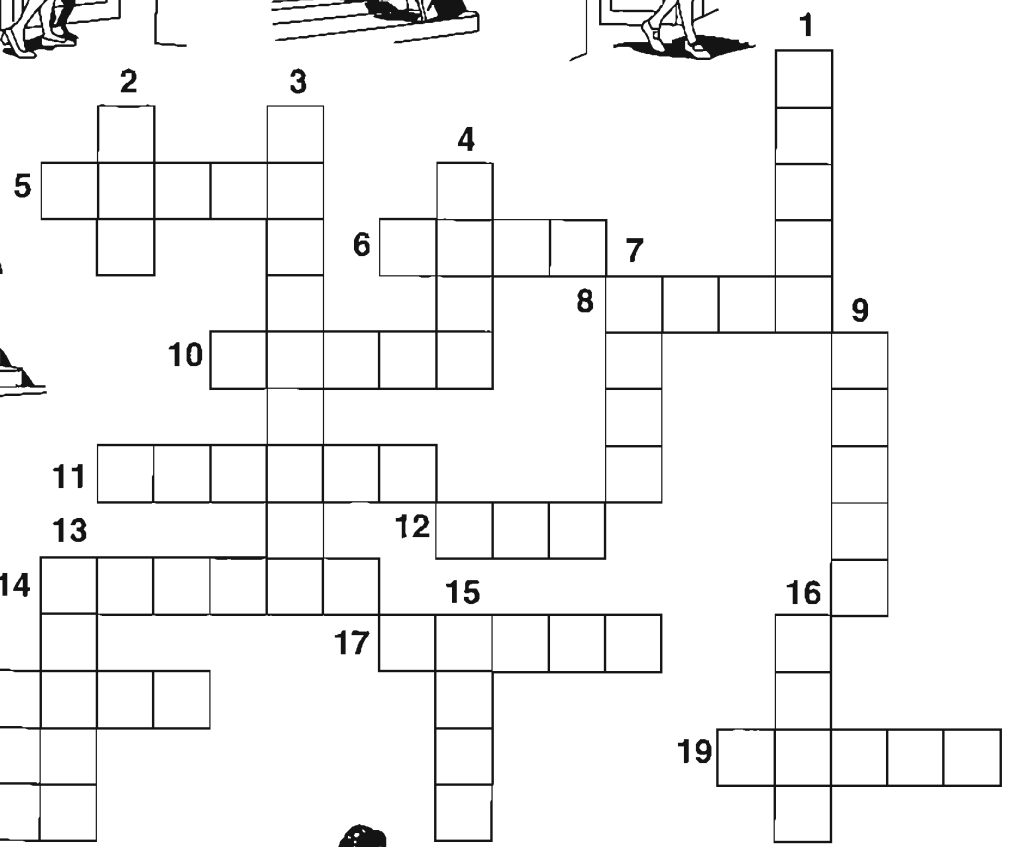
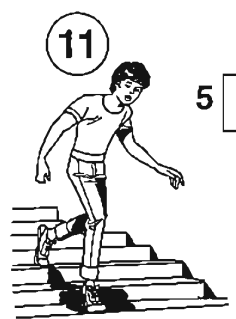
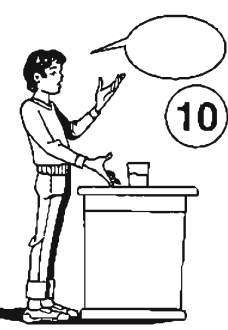



MEANS OF TRANSPORT



bicycle

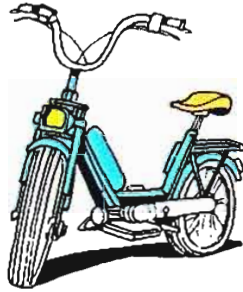

moped



motorbike



car



van



lorry



tractor



taxi



ambulance



fire engine



bus



underground train



train



rowing-boat



motor boat

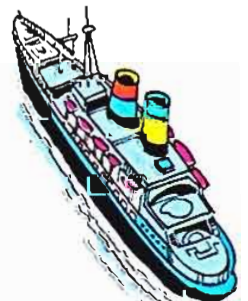

ship



helicopter



aeroplane

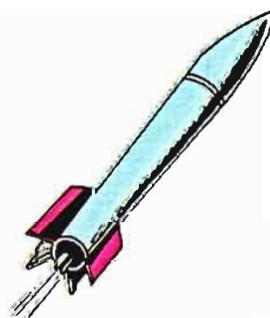

rocket

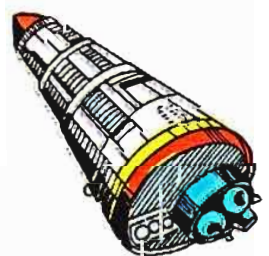

spaceship



1

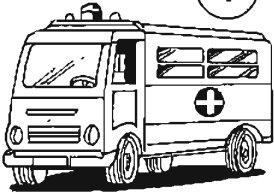

2

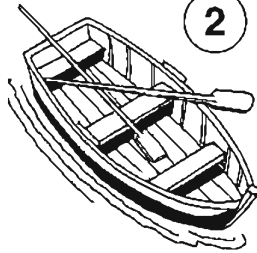

3

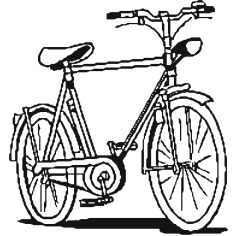

4

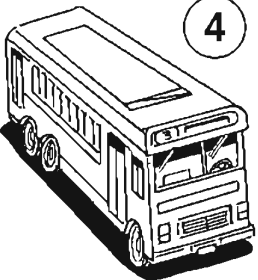

1

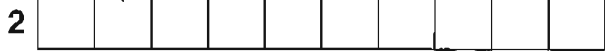

3



4



5



6



7



8

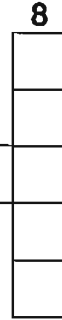

9



10



5

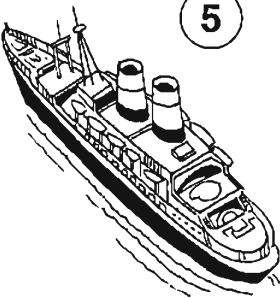

6

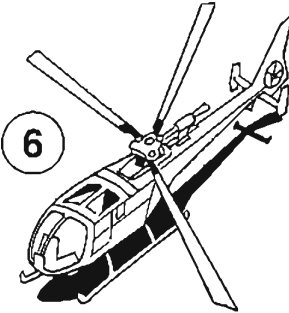

7

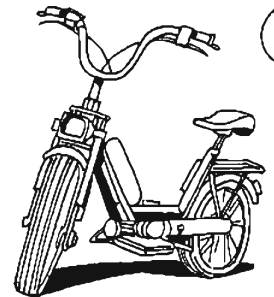

8

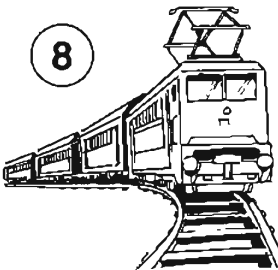

9

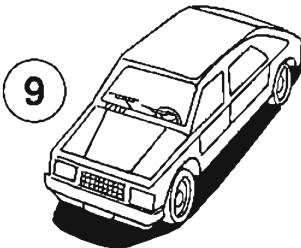

10

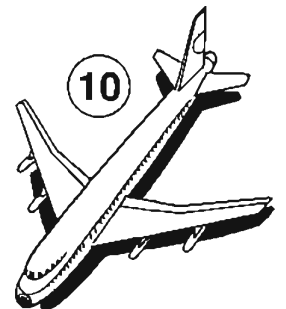

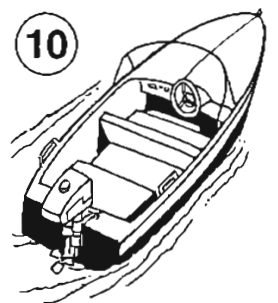
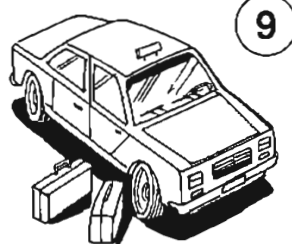
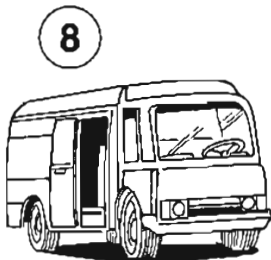
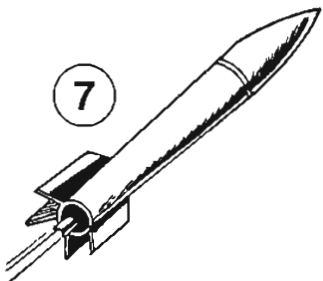
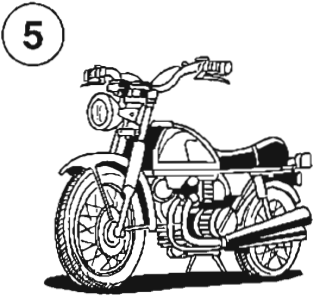
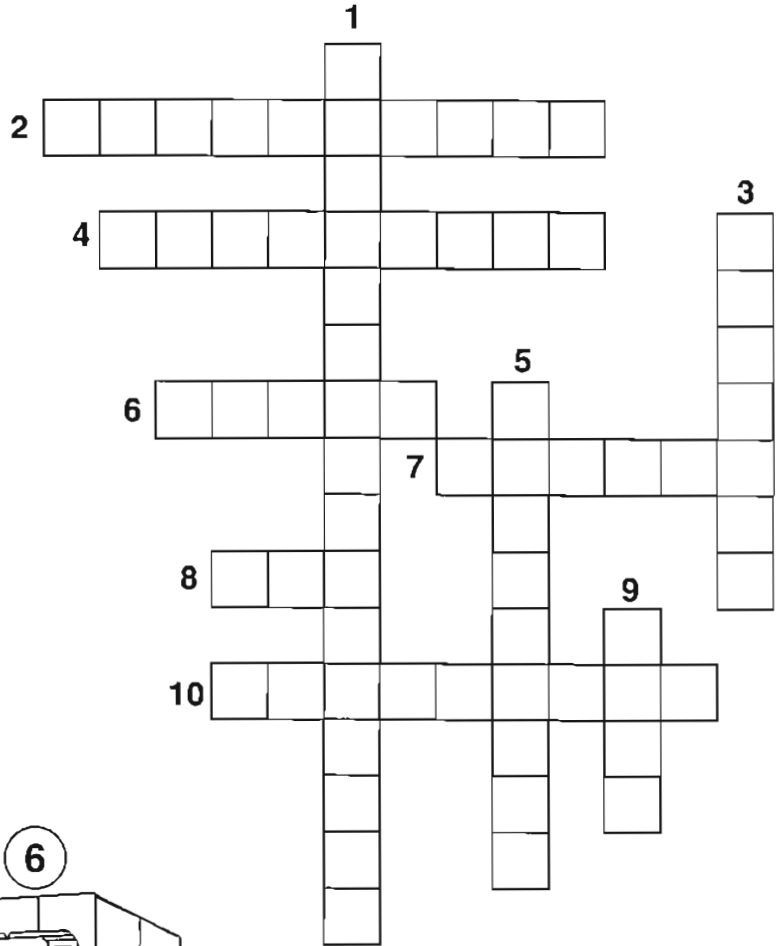
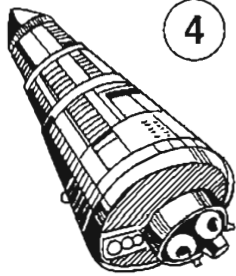
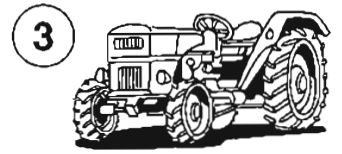
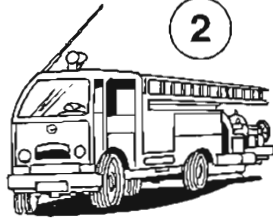

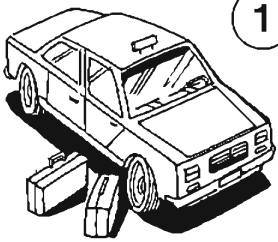

1

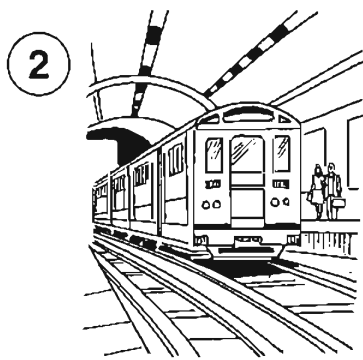

2

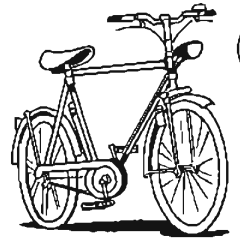

3

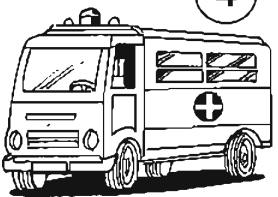

4

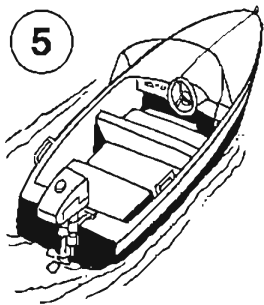
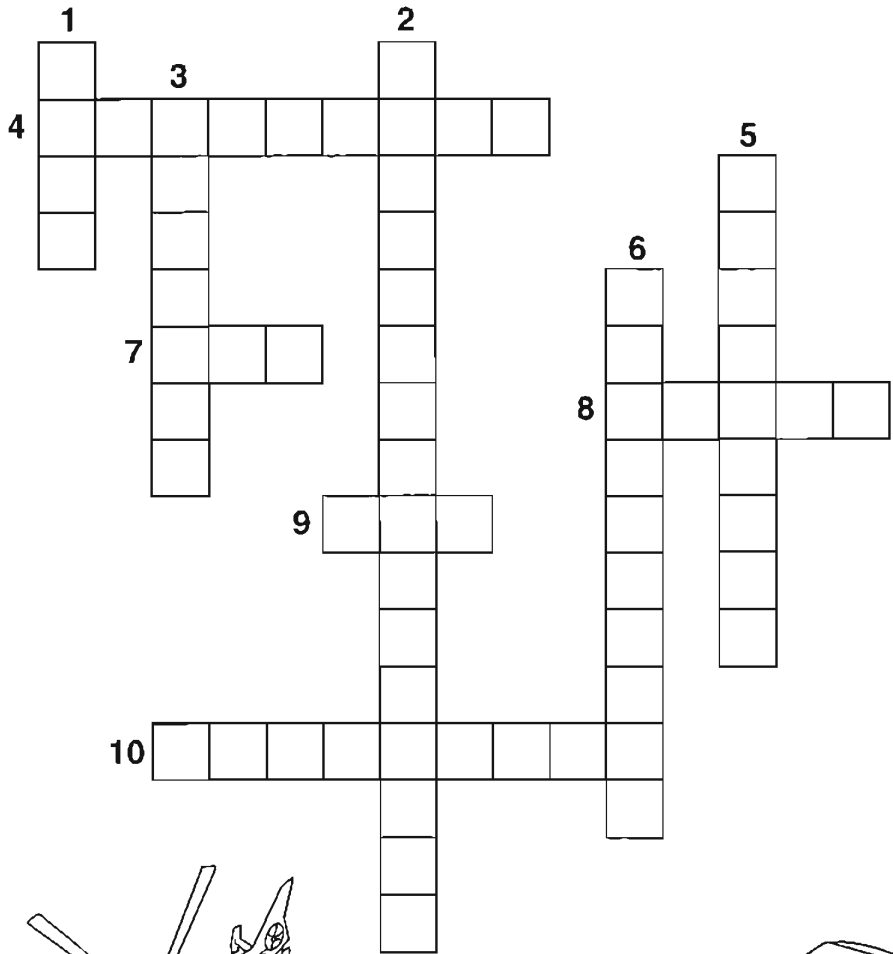

5

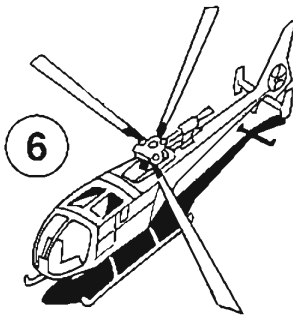

6

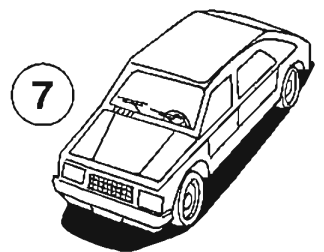

7

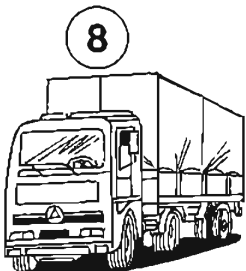

8

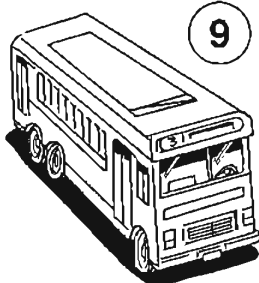

9

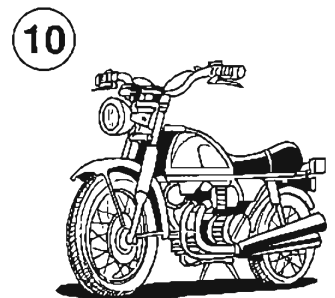

10

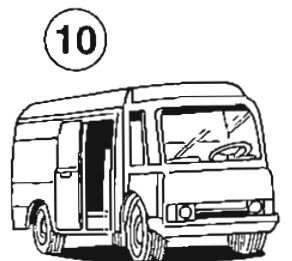
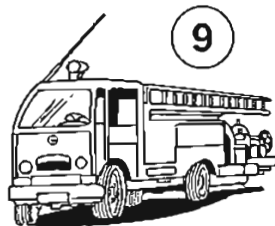
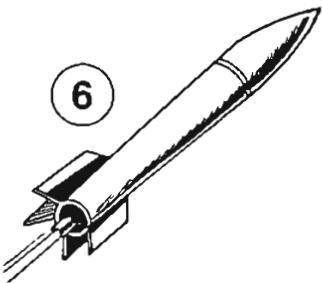
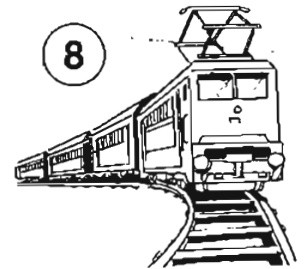
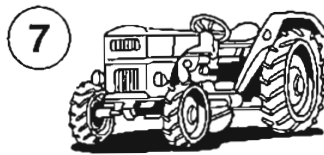
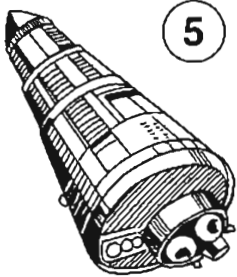
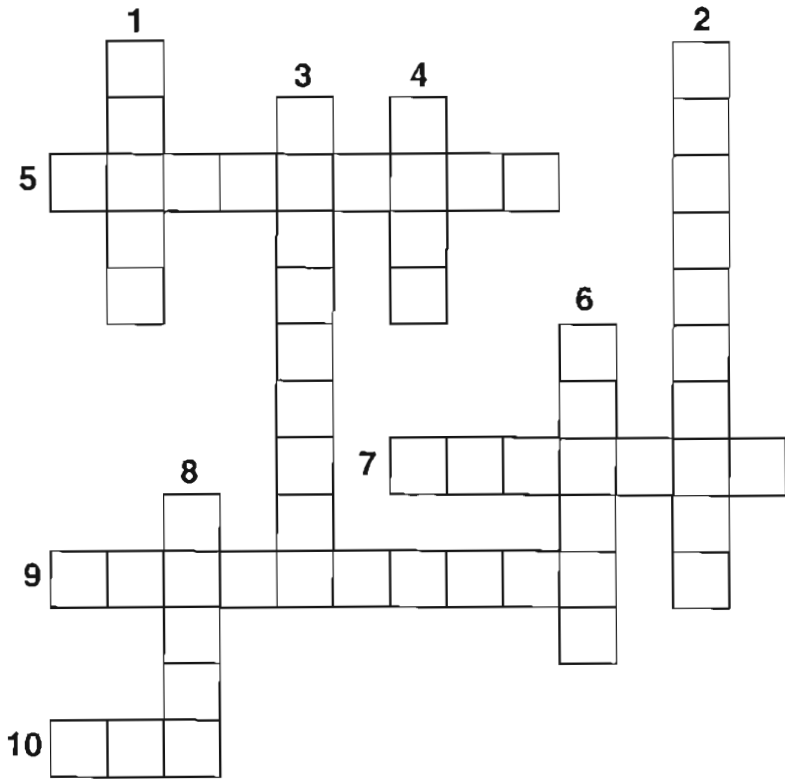
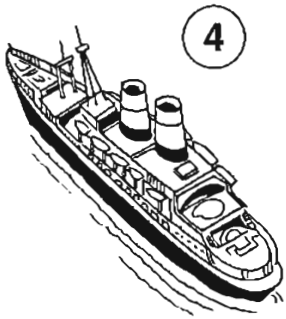
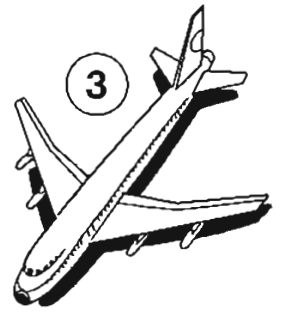
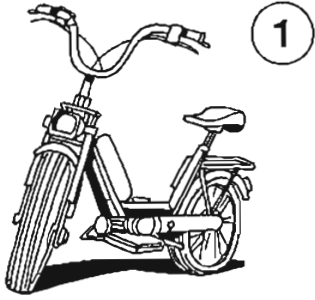

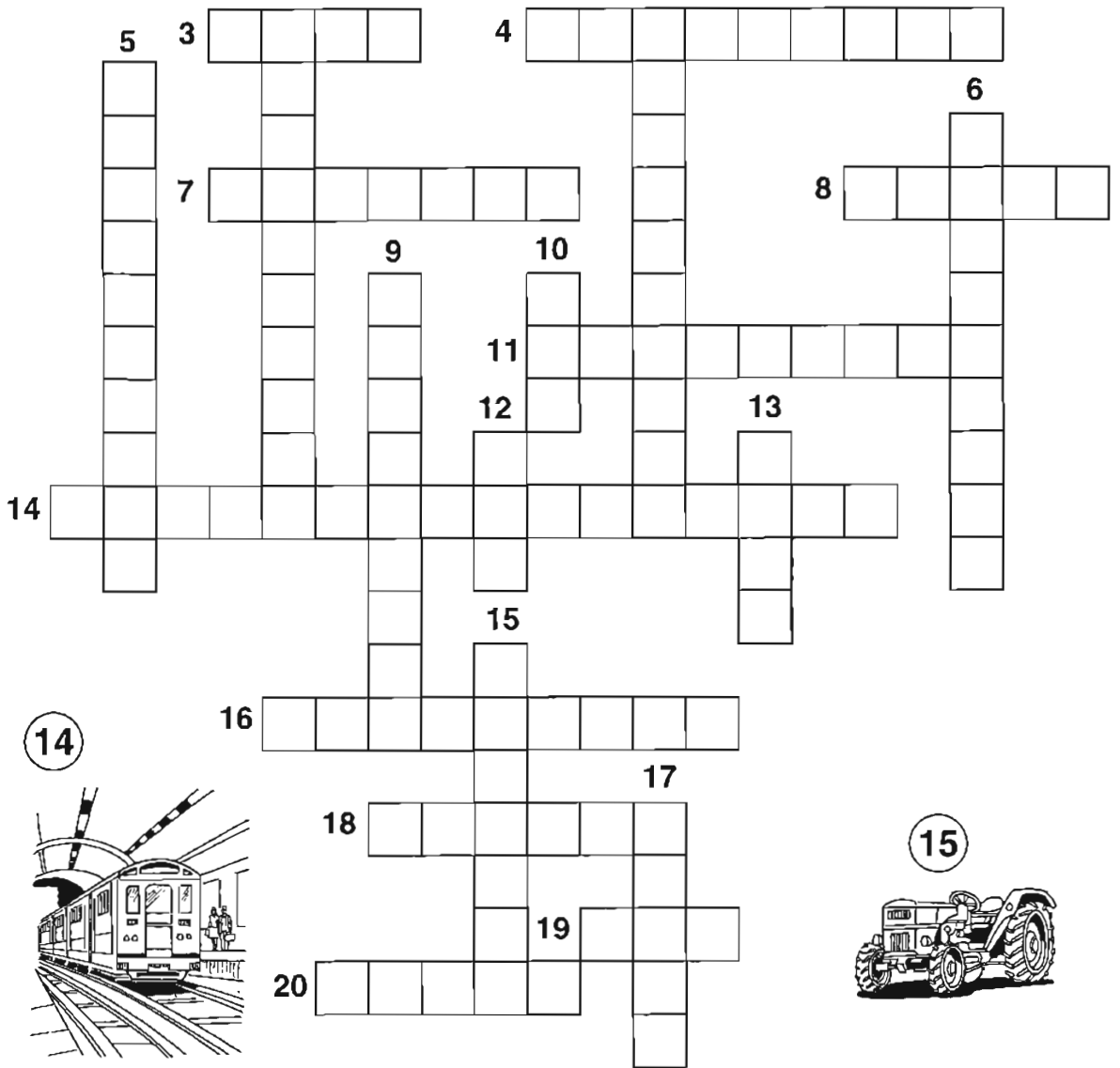
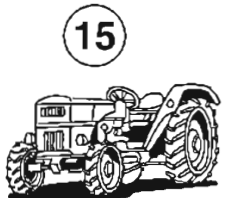
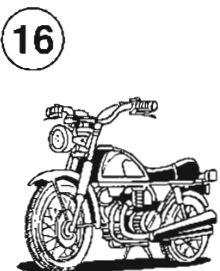
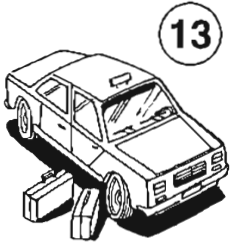
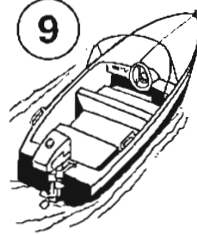
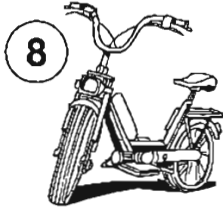
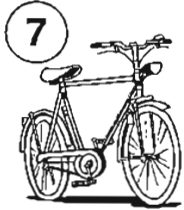
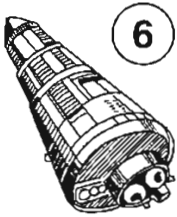
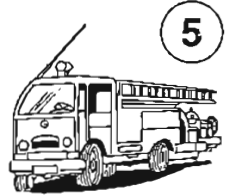
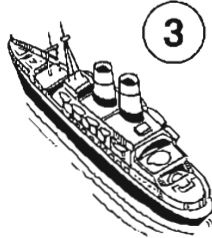
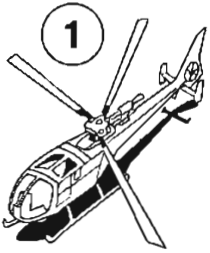



FARM ANIMALS

page 6

bird	cock	frog	mouse
bull	cow	goat	pig
butterfly	dog	goose	rabbit
cat	donkey	hen	sheep
chick	duck	horse	turkey



THE HOUSE

page 12

bathroom	dining room	garage	roof
block of flats	door	gate	stairs
bedroom	flat	hall	steps
ceiling	floor	house	wall
chimney	garden	kitchen	window



FURNITURE

page 18

alarm clock	cushion	mirror	tap
armchair	drawers	picture	TV
bath	fridge	sink	wardrobe
bed	gas rings	sofa	washbasin
chair	lamp	table	washing machine



SPORTS

page 24

baseball	football	riding	swimming
basketball	golf	running	table tennis
canoeing	gymnastic	sailing	tennis
cycling	high jump	skating	volleyball
fencing	judo	skiing	water skiing



FOOD AND DRINK

page 30

biscuits	chicken	ham	sausages
bread	coffee	ice cream	soup
butter	eggs	jam	sugar
cake	fish	meat	tea
cheese	fruit juice	milk	water



FRUIT AND VEGETABLES

page 36

apple	cherries	mushroom	pineapple
apricot	grapes	oranges	plums
banana	lemon	peaches	potatoes
cabbage	lettuce	pear	strawberries
carrots	melon	peas	tomatoes



NATURE

page 42

clouds	lake	river	sun
field	moon	sea	tree
flower	mountains	sky	waterfall
hill	rain	snow	wind
island	rainbow	stars	wood



IN TOWN

page 48

bank	hospital	petrol station	square
car park	hotel	post office	stadium
church	library	restaurant	statue
cinema	park	school	street
factory	pavement	shops	traffic lights



CLOTHES

page 54

coat	pyjamas	shorts	tie
dress	sandals	skirt	trousers
gloves	scarf	slippers	T-shirt
hat	shirt	socks	underwear
jacket	shoes	sweater	wellingtons



ON SAFARI

page 60

bear	giraffe	monkey	snake
camel	gorilla	panda	tiger
crocodile	hippopotamus	penguin	tortoise
deer	kangaroo	rhinoceros	zebra
elephant	lion	seal	wolf



OPPOSITES

page 66

big	fat	old	small
bitter	full	pretty	sweet
cold	hot	short	tall
empty	long	short	thin
fast	new	slow	ugly



AT SCHOOL

page 72

blackboard	exercise book	pen	ruler
book	felt-tip pens	pencil	scissors
chalk	glue	pencil case	stapler
coloured pencils	paintbrush	pencil sharpener	teacher
compass	paints	rubber	waste-paper basket



ACTIONS

page 78

cry	go down	listen	speak
draw	go in	pull	telephone
drink	go out	push	walk
eat	go up	read	watch
fall	laugh	sleep	write



MEANS OF TRANSPORT

page 84

aeroplane	fire engine	motor boat	taxi
ambulance	helicopter	rocket	tractor
bicycle	lorry	rowing-boat	train
bus	moped	ship	underground train
car	motorbike	spaceship	van



An entertaining and effective way to learn new vocabulary.

- Illustrated words make meaning immediate.
- New words are reinforced and recycled in a series of picture crosswords.
- Suitable for self-study or class work.
- Learning English with crosswords is easy and fun!

In this series:

ENGLISH WITH CROSSWORDS 1 Beginners

ENGLISH WITH CROSSWORDS 2 Intermediate

ENGLISH WITH CROSSWORDS 3 Advanced

The series is published in the following language versions:

French: le FRANÇAIS par les MOTS CROISÉS

German: mit KREUZWORTRÄTSELN DEUTSCH lernen

Spanish: el ESPAÑOL en CRUCIGRAMAS

Italian: l'ITALIANO con le PAROLE CROCIATE

ISBN 88-85148-13-1



9 788885 148130